

# SKF spherical plain bearings and rod ends



® SKF is a registered trademark of the SKF Group.

© SKF Group 2013

The contents of this catalogue are the copyright of the publisher and may not be reproduced (even extracts) unless prior written permission is granted. Every care has been taken to ensure the accuracy of the information contained in this catalogue but no liability can be accepted for any loss or damage whether direct, indirect or consequential arising out of the use of the information contained herein.

**PUB BU/P1 06116/1 EN** · May 2013

This publication supersedes publication 4407/II E.

|  |     |   |
|--|-----|---|
| Principles of selection and application .....            | 25  | 1 |
| Radial spherical plain bearings requiring maintenance .. | 99  | 2 |
| Maintenance-free radial spherical plain bearings .....   | 125 | 3 |
| Angular contact spherical plain bearings .....           | 151 | 4 |
| Thrust spherical plain bearings .....                    | 159 | 5 |
| Rod ends requiring maintenance .....                     | 167 | 6 |
| Maintenance-free rod ends .....                          | 189 | 7 |
| Other SKF plain bearings and special solutions .....     | 207 | 8 |
| Product index .....                                      | 213 | 9 |

# Contents

|   |            |
|---|------------|
| <b>Foreword</b> .....   | <b>5</b>   |
| <b>Unit conversions</b> .....   | <b>7</b>   |
| <b>SKF – the knowledge engineering company</b> .....  | <b>8</b>   |
| <b>General product information</b> .....  | <b>13</b>  |
| <b>1 Principles of selection and application</b> .....  | <b>25</b>  |
| Selection of bearing type .....   | 27         |
| Selection of bearing size .....   | 38         |
| Friction .....  | 69         |
| Design of bearing arrangements .....  | 70         |
| Lubrication .....   | 84         |
| Relubrication .....   | 90         |
| Mounting .....  | 92         |
| Dismounting .....   | 96         |
| <b>2 Radial spherical plain bearings requiring maintenance</b> .....                                    | <b>99</b>  |
| Product tables  |            |
| 2.1 Radial spherical plain bearings, steel/steel, metric sizes .....                                    | 104        |
| 2.2 Radial spherical plain bearings, steel/steel, inch sizes .....                                      | 110        |
| 2.3 Radial spherical plain bearings with an extended inner ring, steel/steel, metric sizes ..           | 116        |
| 2.4 Radial spherical plain bearings with an extended inner ring, steel/steel, inch sizes ...            | 120        |
| <b>3 Maintenance-free radial spherical plain bearings</b> .....   | <b>125</b> |
| Product tables  |            |
| 3.1 Maintenance-free radial spherical plain bearings, steel/PTFE sintered bronze,<br>metric sizes ..... | 132        |
| 3.2 Maintenance-free radial spherical plain bearings, steel/PTFE fabric, metric sizes.....              | 134        |
| 3.3 Maintenance-free radial spherical plain bearings, steel/PTFE fabric, inch sizes .....               | 140        |
| 3.4 Maintenance-free radial spherical plain bearings, steel/PTFE FRP, metric sizes .....                | 144        |
| <b>4 Angular contact spherical plain bearings</b> .....   | <b>151</b> |
| Product tables  |            |
| 4.1 Maintenance-free angular contact spherical plain bearings, steel/PTFE FRP .....                     | 156        |
| <b>5 Thrust spherical plain bearings</b> .....  | <b>159</b> |
| Product tables  |            |
| 5.1 Maintenance-free thrust spherical plain bearings, steel/PTFE FRP .....                              | 164        |

|  |            |
|--|------------|
| <b>6 Rod ends requiring maintenance.....</b>   | <b>167</b> |
| Product tables   |            |
| 6.1 Rod ends with a female thread, steel/steel.....                                  | 172        |
| 6.2 Rod ends with a female thread, for hydraulic cylinders, steel/steel.....         | 174        |
| 6.3 Rod ends with a male thread, steel/steel .....                                   | 178        |
| 6.4 Rod ends with a cylindrical section welding shank, steel/steel .....             | 180        |
| 6.5 Rod ends with a rectangular section welding shank, steel/steel .....             | 182        |
| 6.6 Rod ends with a female thread, steel/bronze .....                                | 184        |
| 6.7 Rod ends with a male thread, steel/bronze .....                                  | 186        |
| <b>7 Maintenance-free rod ends .....</b>   | <b>189</b> |
| Product tables   |            |
| 7.1 Maintenance-free rod ends with a female thread, steel/PTFE sintered bronze ..... | 194        |
| 7.2 Maintenance-free rod ends with a male thread, steel/PTFE sintered bronze .....   | 196        |
| 7.3 Maintenance-free rod ends with a female thread, steel/PTFE fabric .....          | 198        |
| 7.4 Maintenance-free rod ends with a male thread, steel/PTFE fabric .....            | 200        |
| 7.5 Maintenance-free rod ends with a female thread, steel/PTFE FRP .....             | 202        |
| 7.6 Maintenance-free rod ends with a male thread, steel/PTFE FRP .....               | 204        |
| <b>8 Other SKF products and services .....</b>                                       | <b>207</b> |
| <b>9 Product index.....</b>  | <b>213</b> |



# Foreword

Many applications require bearings that are suitable for oscillating movements and that can accommodate misalignment. Rolling bearings only partly fulfil these requirements as they are generally designed for continuous rotation and can only accommodate limited misalignment.

Therefore, SKF manufactures spherical plain bearings and rod ends to provide an economical solution to these challenges.

This catalogue presents the current assortment of SKF spherical plain bearings and rod ends.

## Structure of the catalogue

The catalogue starts with general product information, followed by nine main chapters, which are marked with numbered blue tabs in the right margin:

- Chapter 1 provides design and application recommendations.
- Chapters 2 to 7 describe the various bearing and rod end types. Each chapter contains descriptions of the products as well as product tables, listing data for selecting a bearing or rod end and designing the bearing arrangement.
- Chapter 8 is an overview about other SKF products and services.
- In chapter 9, all products presented in this catalogue are listed in alphabetical order by designation.

## About the data in this catalogue

The data in this catalogue relate to SKF's state-of-the-art technology and production capabilities as of beginning 2010. The data may differ from that shown in earlier catalogues because of revised methods of calculation, redesign or technological developments. For example, the following new information and product data

have been included for radial spherical plain bearings:

- Bearings in the TX series have been added and are available with bore diameters up to 800 mm.
- Bearings in the maintenance-free series are fitted with LS seals as standard.
- Bearings with the sliding material FSA have been replaced by the FBAS design.
- Bearings requiring maintenance are also available with LS seals.
- Part of the inch assortment is also available with LS seals.

SKF reserves the right to make continuing improvements to SKF products with respect to materials, design and manufacturing methods, as well as changes necessitated by technological developments.

The units used in this catalogue are in accordance with ISO (International Organization for Standardization) standard 1000:1992, and SI (Système International d'Unités). Unit conversions are listed in the table on **page 7**.

## Other SKF catalogues

The total SKF product portfolio is much broader than just spherical plain bearings and rod ends. Product information is also available via the SKF website at [www.skf.com](http://www.skf.com). The *SKF Interactive Engineering Catalogue* provides not only product information, but also online calculation tools, CAD drawings in various formats, and search and selection functions.

The main printed SKF catalogues are:

- General catalogue
- Needle roller bearings
- High-precision bearings
- Y-bearings and Y-bearing units

- Bearing housings
- Slewing bearings
- Linear motion standard range
- SKF Maintenance and Lubrication Products
- Centralized lubrication systems
- Industrial shaft seals
- SKF Power transmission products

For additional information about SKF products and services, contact your local SKF representative or SKF Authorized Distributor.

### **More advantages**

SKF aims to deliver industry-leading, high value products, services and knowledge-engineered solutions. Many of the product's capabilities contribute to the overall value customers receive in making SKF their supplier of choice, such as:

- simplified bearing selection
- short delivery times
- worldwide availability
- commitment to product innovation
- state-of-the-art application solutions
- extensive engineering and technology knowledge in virtually every industry



## Unit conversions

| Quantity                | Unit                   | Conversion          |                          |                |                             |
|-------------------------|------------------------|---------------------|--------------------------|----------------|-----------------------------|
| <b>Length</b>           | inch                   | 1 mm                | 0,03937 in               | 1 in           | 25,40 mm                    |
|                         | foot                   | 1 m                 | 3,281 ft                 | 1 ft           | 0,3048 m                    |
|                         | yard                   | 1 m                 | 1,094 yd                 | 1 yd           | 0,9144 m                    |
|                         | mile                   | 1 km                | 0,6214 mile              | 1 mile         | 1,609 km                    |
| <b>Area</b>             | square inch            | 1 mm <sup>2</sup>   | 0,00155 sq.in            | 1 sq.in        | 645,16 mm <sup>2</sup>      |
|                         | square foot            | 1 m <sup>2</sup>    | 10,76 sq.ft              | 1 sq.ft        | 0,0929 m <sup>2</sup>       |
| <b>Volume</b>           | cubic inch             | 1 cm <sup>3</sup>   | 0,061 cub.in             | 1 cub.in       | 16,387 cm <sup>3</sup>      |
|                         | cubic foot             | 1 m <sup>3</sup>    | 35 cub.ft                | 1 cub.ft       | 0,02832 m <sup>3</sup>      |
|                         | imperial gallon        | 1 l                 | 0,22 gallon              | 1 gallon       | 4,5461 l                    |
|                         | U.S. gallon            | 1 l                 | 0,2642 U.S. gallon       | 1 U.S. gallon  | 3,7854 l                    |
| <b>Velocity, speed</b>  | foot per second        | 1 m/s               | 3,28 ft/s                | 1 ft/s         | 0,30480 m/s                 |
|                         | mile per hour          | 1 km/h              | 0,6214 mile/h (mph)      | 1 mile/h (mph) | 1,609 km/h                  |
| <b>Mass</b>             | ounce                  | 1 g                 | 0,03527 oz               | 1 oz           | 28,350 g                    |
|                         | pound                  | 1 kg                | 2,205 lb                 | 1 lb           | 0,45359 kg                  |
|                         | short ton              | 1 tonne             | 1,1023 short ton         | 1 short ton    | 0,90719 tonne               |
|                         | long ton               | 1 tonne             | 0,9842 long ton          | 1 long ton     | 1,0161 tonne                |
| <b>Density</b>          | pound per cubic inch   | 1 g/cm <sup>3</sup> | 0,0361 lb/cub.in         | 1 lb/cub.in    | 27,680 g/cm <sup>3</sup>    |
| <b>Force</b>            | pound-force            | 1 N                 | 0,225 lbf                | 1 lbf          | 4,4482 N                    |
| <b>Pressure, stress</b> | pounds per square inch | 1 MPa               | 145 psi                  | 1 psi          | 6,8948 × 10 <sup>3</sup> Pa |
| <b>Moment</b>           | inch pound-force       | 1 Nm                | 8,85 in.lbf              | 1 in.lbf       | 0,113 Nm                    |
| <b>Power</b>            | foot-pound per second  | 1 W                 | 0,7376 ft lbf/s          | 1 ft lbf/s     | 1,3558 W                    |
|                         | horsepower             | 1 kW                | 1,36 HP                  | 1 HP           | 0,736 kW                    |
| <b>Temperature</b>      | degree                 | Celsius             | $t_C = 0,555 (t_F - 32)$ | Fahrenheit     | $t_F = 1,8 t_C + 32$        |

# This is SKF

From one simple but inspired solution to a misalignment problem in a textile mill in Sweden, and fifteen employees in 1907, SKF has grown to become a global industrial knowledge leader. Over the years we have built on our expertise in bearings, extending it to seals, mechatronics, services and lubrication systems. Our knowledge network includes 46 000 employees, 15 000 distributor partners, offices in more than 130 countries, and a growing number of SKF Solution Factory sites around the world.



## Research and development

We have hands-on experience in over 40 industries, based on our employees' knowledge of real life conditions. In addition our world-leading experts and university partners who pioneer advanced theoretical research and development in areas including tribology, condition monitoring, asset management and bearing life theory. Our ongoing commitment to



*SKF Solution Factory makes SKF knowledge and manufacturing expertise available locally, to provide unique solutions and services to our customers.*

research and development helps us keep our customers at the forefront of their industries.

### Meeting the toughest challenges

Our network of knowledge and experience along with our understanding of how our core technologies can be combined helps us create innovative solutions that meet the toughest of challenges. We work closely with our customers throughout the asset life cycle, helping them to profitably and responsibly grow their businesses.



### Working for a sustainable future

Since 2005, SKF has worked to reduce the negative environmental impact from our own operations and those of our suppliers. Our continuing technology development introduced the SKF BeyondZero portfolio of products and services which improve efficiency and reduce energy losses, as well as enable new technologies harnessing wind, solar and ocean power. This combined approach helps reduce the environmental impact both in our own operations and in our customers'.

*Working with SKF IT and logistics systems and application experts, SKF Authorized Distributors deliver a valuable mix of product and application knowledge to customers worldwide.*



# SKF – the knowledge engineering company

## Our knowledge – your success

*SKF Life Cycle Management is how we combine our technology platforms and advanced services, and apply them at each stage of the asset life cycle, to help our customers to be more successful, sustainable and profitable.*

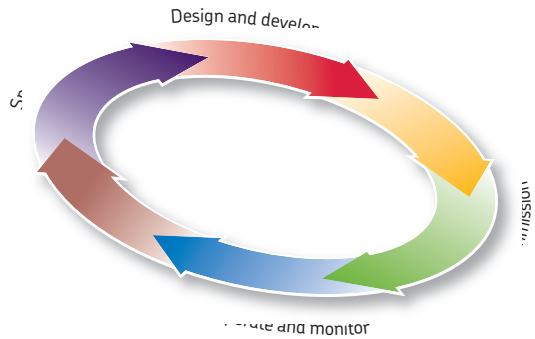

### Working closely with you

Our objective is to help our customers improve productivity, minimize maintenance, achieve higher energy and resource efficiency, and optimize designs for long service life and reliability.

### Innovative solutions

Whether the application is linear or rotary or a combination of the two, SKF engineers can work with you at each stage of the asset life cycle to

improve machine performance by looking at the entire application. This approach doesn't just focus on individual components like bearings or seals. It looks at the whole application to see how each component interacts with the next.

### Design optimization and verification

SKF can work with you to optimize current or new designs with proprietary 3-D modelling software that can also be used as a virtual test rig to confirm the integrity of the design.



### **Bearings**

*SKF is the world leader in the design, development and manufacture of high performance rolling bearings, plain bearings, bearing units and housings.*



### **Machinery maintenance**

*Condition monitoring technologies and maintenance services from SKF can help minimize unplanned downtime, improve operational efficiency and reduce maintenance costs.*



### **Sealing solutions**

*SKF offers standard seals and custom engineered sealing solutions to increase uptime, improve machine reliability, reduce friction and power losses, and extend lubricant life.*



### **Mechatronics**

*SKF fly-by-wire systems for aircraft and drive-by-wire systems for off-road, agricultural and forklift applications replace heavy, grease or oil consuming mechanical and hydraulic systems.*



### **Lubrication solutions**

*From specialized lubricants to state-of-the-art lubrication systems and lubrication management services, lubrication solutions from SKF can help to reduce lubrication related downtime and lubricant consumption.*



### **Actuation and motion control**

*With a wide assortment of products – from actuators and ball screws to profile rail guides – SKF can work with you to solve your most pressing linear system challenges.*



# General product information

|  |           |
|--|-----------|
| <b>Properties .....</b>                                    | <b>14</b> |
| Spherical plain bearings .....                             | 14        |
| Rod ends .....   | 15        |
| <b>Bearing designs and features.....</b>                   | <b>16</b> |
| Bearings and rod ends requiring maintenance.....           | 17        |
| The multi-groove system .....                              | 17        |
| Maintenance-free, long-life sliding contact surfaces ..... | 18        |
| Optional SKF design features.....                          | 19        |
| A choice of materials .....                                | 19        |
| With or without seals.....                                 | 19        |
| Wide operating temperature range .....                     | 19        |
| <b>Multi-purpose performance .....</b>                     | <b>20</b> |
| Typical applications.....                                  | 20        |
| Application examples.....                                  | 20        |
| Suspended roof.....  | 20        |
| Road roller articulation joint.....                        | 21        |
| Truck twin-axle supports .....                             | 21        |
| Dam gates .....  | 22        |
| Hydraulic and pneumatic cylinders.....                     | 22        |
| Newspaper conveyor .....                                   | 22        |

# Properties

## Spherical plain bearings

Spherical plain bearings are standardized, ready-to-mount, mechanical components that enable multi-directional, self-aligning movements. The inner ring has a spherical convex outside diameter, while the outer ring has a correspondingly concave inside diameter (→ **fig. 1**). The forces acting on the bearing may be static or may occur when the bearing makes oscillating or recurrent tilting and slewing movements at relatively low speeds.

Design advantages inherent to spherical plain bearings include the ability to:

- accommodate misalignment (→ **fig. 2**)
- virtually eliminate edge stresses and excessive stressing of adjacent components (→ **fig. 3**)
- accommodate deformation of surrounding components in operation (→ **fig. 4**)
- accommodate wide manufacturing tolerances and the use of cost-effective, welded assemblies (→ **fig. 5**)

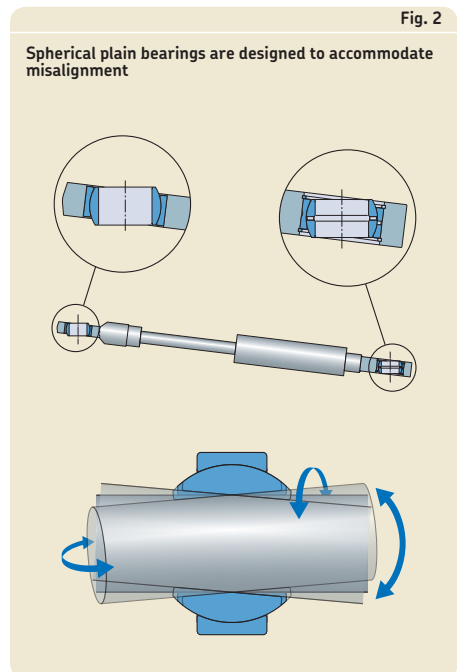
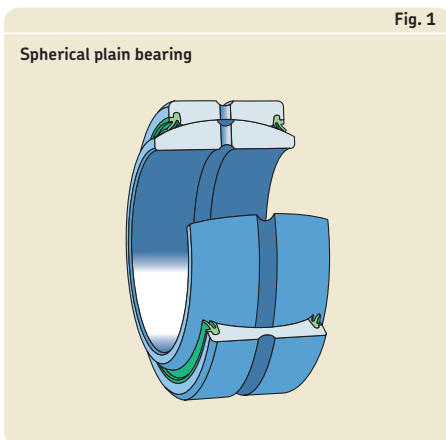



Fig. 3

Compared to bushings, spherical plain bearings provide higher reliability, as the chance of edge stresses and overloading are virtually non-existent

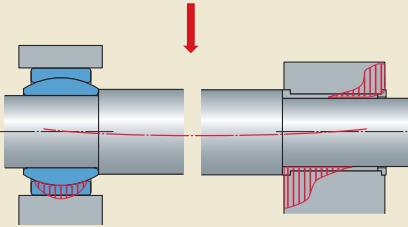

Fig. 4

Shaft deflection does not have a negative influence on bearing service life, the shaft or housing

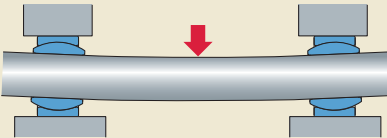
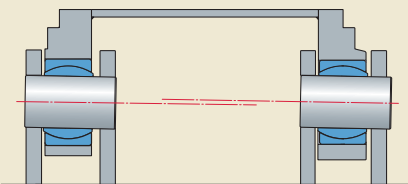

Fig. 5

Spherical plain bearings can accommodate the wide manufacturing tolerances found in cost-effective welded assemblies



## Rod ends

Spherical plain bearing rod ends are bearing units that consist of a spherical plain bearing in the eye-shaped head of the rod end housing (→ fig. 6). They are used primarily on the ends of hydraulic or pneumatic pistons to join the cylinder to an associated component via an internal (female) thread, external (male) thread or a welding shank (→ fig. 7 on page 16).

SKF supplies rod ends with a threaded shank with a right-hand thread as standard. With the exception of rod ends with the designation suffix VZ019, all rod ends are also available with a left-hand thread. They are identified by the designation prefix L.

Fig. 6

Rod end with a male thread

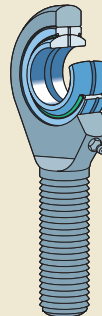

# Bearing designs and features

SKF spherical plain bearings and rod ends are an excellent choice for applications that require total design economy. These state-of-the-art products are available in a wide assortment of designs, dimension series and sizes to meet the needs of a particular application. **Fig. 7** shows the general bearing and rod end types.

Whether the application calls for a large spherical plain bearing or a small rod end assembly, both are available from SKF and offer:

- long service life
- minimal maintenance
- high operational reliability

SKF spherical plain bearings and rod ends, produced with standard dimensions, are available

worldwide, making them readily accessible whenever and wherever they are needed.

Economic considerations and unparalleled design characteristics are not the only reasons that SKF spherical plain bearings and rod ends are the ultimate solution for any plain bearing application. Their designs, materials and manufacturing quality enable long service life and high reliability even in the most demanding applications.

Fig. 7

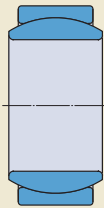

Radial spherical plain bearing



Angular contact spherical plain bearing

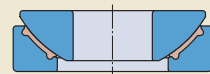

Thrust spherical plain bearing



Rod end with a female thread



Rod end with a male thread

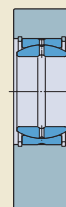

Rod end with a welding shank

## Bearings and rod ends requiring maintenance

Bearings and rod ends requiring maintenance must be greased prior to being put into operation. With the exception of a few applications, they must be relubricated periodically.

SKF steel/steel radial spherical plain bearings are made of bearing steel and are through-hardened. The high-strength sliding contact surfaces are phosphated and treated with a special running-in lubricant. These bearings are used primarily in applications where there are:

- heavy static loads
- heavy alternating loads
- shock loads

They are also relatively insensitive to contaminants and high temperatures.

To facilitate relubrication, lubrication holes and grooves are provided in both the inner and outer rings of all steel/steel radial spherical plain bearings – with the exception of a few small sizes. SKF steel/bronze rod ends also require relubrication. However, requirements are less stringent than for steel/steel rod ends, as the emergency running properties of bronze are more forgiving than steel.

### The multi-groove system

Standard steel/steel radial spherical plain bearings that must accommodate minor alignment movements under very heavy, constant direction loads are prone to lubricant starvation. To maximize the effects of the lubricant under these conditions, SKF has developed the multi-groove system and manufactures all metric steel/steel radial spherical plain bearings with an outside diameter  $D \geq 150$  mm with the multi-groove system on the sliding surface of the outer ring as standard (→ **fig. 8**). Metric steel/steel radial spherical plain bearings with an outside diameter  $D < 150$  mm can be supplied with the multi-groove system on request. These bearings are identified by the designation suffix ESL.

These lubrication grooves provide the following benefits:

- improved lubricant supply to the loaded zone
- enlarged lubricant reservoir in the bearing
- enable relubrication under load
- extended relubrication intervals
- space for wear particles and contaminants
- extended grease life

The main benefit of the multi-groove system is that it improves lubricant distribution in the heavily loaded zone to extend service life and/or maintenance intervals.

Fig. 8

Steel/steel radial spherical plain bearing with the multi-groove system



## Maintenance-free, long-life sliding contact surfaces

“Maintenance-free” is an industry-wide term used to describe plain bearings and rod ends with self-lubricating sliding contact surface combinations. The term maintenance-free does not imply that these bearings should not be inspected as part of a regularly scheduled maintenance program.

These so-called maintenance-free bearings and rod ends offer a number of advantages for OEMs and end users alike. These advantages, which include minimal maintenance and reduced lubricant consumption, quickly compensate for the difference in the initial purchase price when compared to standard steel/steel bearing solutions. And of course, the impact that maintenance-free bearings have on the environment is an added benefit.

To offer maintenance-free solutions for the greatest number of applications, SKF produces spherical plain bearings and rod ends with different sliding contact surface combinations (→ fig 9). These combinations, which in some cases are size dependent, include:

- steel/PTFE (polytetrafluoroethylene) sintered bronze
- steel/PTFE fabric
- steel/PTFE FRP (fibre reinforced polymer)

Maintenance-free bearings can operate without grease, and therefore do not need to be relubricated. Depending on the sliding surfaces, grease

can improve bearing service life or can have a negative effect on it. Therefore, SKF does not recommend the use of lubricants for bearings with steel/PTFE sintered bronze or steel/PTFE fabric sliding contact surface combinations, whereas initial lubrication followed by occasional relubrication of steel/PTFE FRP bearings can extend the service life of the bearing.

Be aware that “maintenance-free” refers to bearing service life only, and does not refer to the service life of an application or general maintenance intervals of other machine parts in the application. For detailed information about the life of spherical plain bearings or rod ends, refer to the section *Basic rating life* starting on **page 39**. The basic rating life as a guideline value for the service life under certain operating conditions can be calculated using the information provided in the section *Basic rating life calculation* starting on **page 51**.

Self-lubricating, dry sliding materials are not as stiff as steel and consequently are subject to greater deformation under load than steel. These sliding materials are also more sensitive than steel to alternating or shock loads. If either of these load conditions exists, contact the SKF application engineering service.

Maintenance-free bearings and rod ends are designed for applications where:

- load direction is constant and may be heavy
- low coefficient of friction is necessary
- relubrication is not possible or difficult



# Optional SKF design features

## A choice of materials

For most applications, SKF spherical plain bearings made of standard bearing steel requiring maintenance are an excellent choice. However, for difficult operating environments, SKF maintenance-free stainless steel spherical plain bearings may be preferred. For other material options, e.g. surface treatments, contact the SKF application engineering service.

## With or without seals

Most popular sizes of SKF spherical plain bearings are available either open (without seals) or sealed on both sides (→ **fig. 10**). Standard sealed bearings can increase the service life of a bearing and save space, while reducing inventory and assembly costs. Maintenance-free bearings without seals have to be protected against contaminants.

Spherical plain bearings fitted on both sides with the SKF RS double lip seal are very effective, under normal operating conditions, at keeping contaminants away from the sliding contact surfaces. These seals also effectively retain the grease and therefore are appropriate for bearings requiring maintenance.

Maintenance-free bearings and all bearings operating in highly contaminated environments should be fitted with the SKF LS triple-lip heavy-duty contact seal (→ **page 79**). They are reinforced with a steel insert and have three seal lips. These very effective seals protect the bearing against contaminants and enhance the operational reliability of the spherical plain bearing.

## Wide operating temperature range

SKF spherical plain bearings and rod ends can operate effectively over a wide temperature range. The operating temperature range of open (without seals) steel/steel radial spherical plain bearings is  $-50$  to  $+200$  °C.

Fig. 10

Many sealing problems can be solved economically and in a space-saving manner using sealed bearings

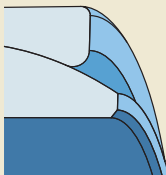

without seal  
(open design)

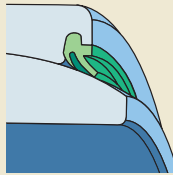

double-lip seal  
(RS design)

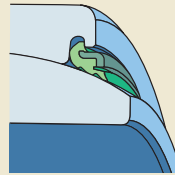

triple-lip heavy-duty seal  
(LS design)

# Multi-purpose performance

## Typical applications

Long service life, high reliability and minimal maintenance are some of the features of SKF spherical plain bearings and rod ends. SKF's wide assortment of spherical plain bearings and rod ends is versatile enough to be used in a variety of applications that encompass almost all sectors of industry, including:

- agriculture
- construction
- forklift trucks
- material handling
- metals
- mining
- railways
- trucks
- wind energy

## Application examples

### Suspended roof

SKF steel/steel radial spherical plain bearings are in service in an unusual and world-renowned application, the roof of the Olympic Stadium in Munich, Germany (→ **fig. 11**). The roof is constructed of a number of pre-stressed steel cables in a network. The nodal points of the network must be torque-free. That is where 225 standard SKF steel/steel radial spherical plain bearings with bore diameters ranging from 160 to 300 mm are located. The nodes are statically loaded but must enable occasional swinging movements of the roof construction.

Although SKF steel/steel radial spherical plain bearings are typically not maintenance-free, these particular bearings have not been relubricated since the construction of the building in 1972.

What better proof could there be for lasting quality and reliability?

Fig. 11

Nodal points of suspended roof construction of the Olympic Stadium in Munich, Germany

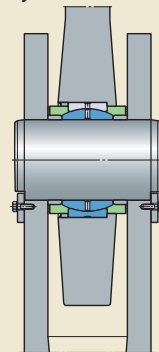

### Road roller articulation joint

SKF spherical plain bearings in the articulation joint between the front and rear rollers (→ **fig. 12**) enable a road roller to manoeuvre. This joint must be able to withstand very heavy radial loads and high vibration levels. Due to their location, the bearings should be protected as they are exposed to a variety of contaminants including dust, dirt, water and hot tarmac, which promote premature wear and corrosion.

SKF maintenance-free spherical plain bearings help to eliminate the need for relubrication, and reduce the total cost of ownership.

### Truck twin-axle supports

An SKF spherical plain bearing arrangement on the truck twin-axle support provides even load

distribution between the two axles for trucks driving on rough roads or off-highway conditions (→ **fig. 13**). This bearing arrangement is subjected to heavy loads and, depending on the conditions, heavy shock loads, and frequent alignment movements.

These bearings are located behind the tires in an area that is very difficult to access, making it imperative that sudden bearing damage or failure, requiring immediate roadside repairs, be avoided at all cost. A pair of SKF angular contact spherical plain bearings mounted in a back-to-back arrangement can help prevent these emergencies. These bearings, which can withstand all the rigours of truck duty, are simple to install and easy to maintain.

Fig. 12

Road roller articulation joint

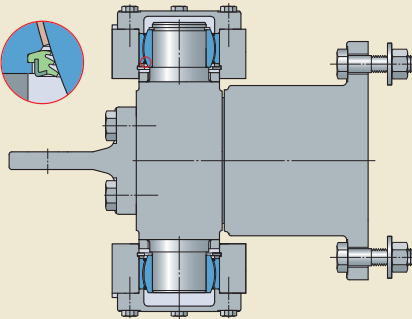
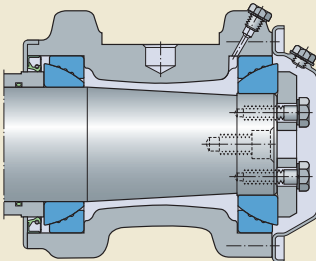

Fig. 13

Truck twin-axle supports



## General product information

### Dam gates

Segment gates for dams and other barrages are home to large-size SKF maintenance-free spherical plain bearings (→ **fig. 14**). The reference list is very long – with over 3 000 applications to date.

As main bearings, they compensate for shaft misalignment, caused by thermal expansion and contraction, elastic deformation of the dam gates as well as changes caused by settling of the foundation. These bearings cope with the heavy radial loads caused by water pressure as well as axial loads that arise from the inclined position of the support arms.

In addition, SKF spherical plain bearings not only serve as heavily loaded bearings under static conditions, they also operate in the frequently used linkage attachments of the lifting and plunger cylinders as well as the flaps.

### Hydraulic and pneumatic cylinders

SKF steel/steel and steel/bronze rod ends are frequently used on hydraulic and pneumatic cylinders (→ **fig. 15**). Acting as the link between the cylinder and its attachments, they are able to transmit heavy mechanical loads.

Hydraulic cylinders (e.g. to ISO 8132) are often fitted with steel/steel rod ends with a female thread that can be secured (compressible) on one end and a steel/steel rod end with a welding shank on the other.

These types of hydraulic cylinders can be found in all types of construction equipment, agricultural machinery, lifting equipment and shutters, recycling depot presses as well as other heavily loaded manoeuvring equipment.

In pneumatic cylinders where working pressures regularly reach 1 MPa, steel/bronze rod ends and maintenance-free rod ends are typically used at the end of the piston rod. At the opposite end, SKF rod ends with a welding shank are used.

### Newspaper conveyor

Speed and flexibility are all-important when producing newspapers, not only in the printing process, but also in distribution. The conveyor system from the printing press to the loading dock is a very important component if the newspapers are to be delivered on time.

The endless conveyor chain is one such system. It consists of a multitude of links, which together provide the speed and flexibility required. **Fig. 16** shows an application where more than 1 000 SKF maintenance-free spherical plain bearings with the sliding contact surface combination steel/PTFE sintered bronze are used. The bearings have been in daily service without maintenance for many years.



Fig. 14

Dam gates

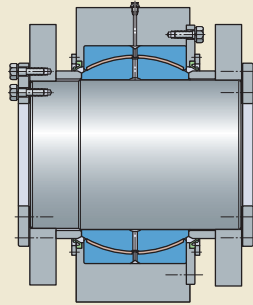
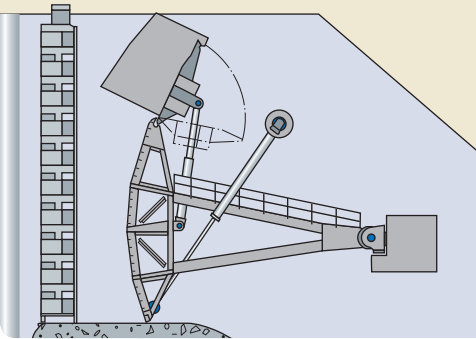

Fig. 15

Hydraulic and pneumatic cylinders



Fig. 16

Newspaper conveyor

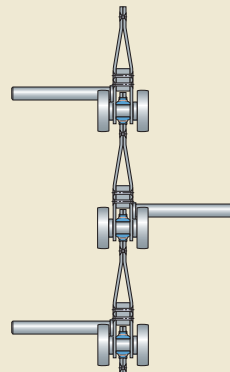

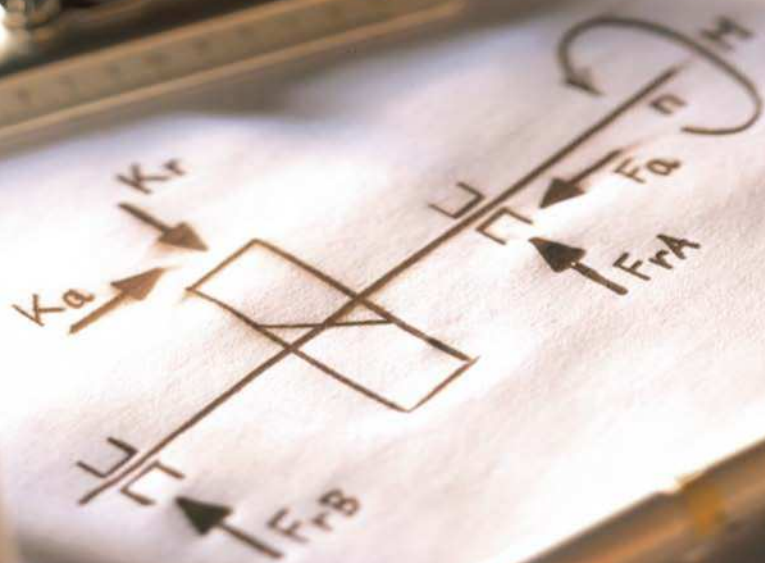

# Principles for selection and application

|   |           |
|---|-----------|
| <b>Selection of bearing type .....</b>  | <b>25</b> |
| Bearing terminology.....  | 27        |
| Bearing types.....  | 28        |
| Radial spherical plain bearings requiring maintenance.....  | 28        |
| Maintenance-free radial spherical plain bearings .....  | 30        |
| Angular contact spherical plain bearings .....  | 33        |
| Thrust spherical plain bearings.....  | 34        |
| Rod ends with a threaded shank, requiring maintenance .....                                       | 34        |
| Rod ends with a welding shank, requiring maintenance .....  | 36        |
| Maintenance-free rod ends with a threaded shank.....  | 37        |
| <b>Selection of bearing size .....</b>  | <b>38</b> |
| Load ratings .....  | 38        |
| Basic dynamic load rating .....   | 38        |
| Basic static load rating .....  | 38        |
| Basic rating life .....   | 39        |
| Load.....   | 41        |
| Equivalent dynamic bearing load .....   | 41        |
| Equivalent static bearing load .....  | 43        |
| Permissible loads for rod ends .....  | 44        |
| Requisite bearing size.....   | 45        |
| Specific bearing load .....   | 46        |
| Mean sliding velocity.....  | 46        |
| Basic rating life calculation .....   | 51        |
| Steel/steel and steel/bronze sliding contact surface combinations,<br>requiring maintenance ..... | 51        |
| Maintenance-free steel/PTFE sintered bronze sliding contact surface combination .....             | 54        |
| Maintenance-free steel/PTFE fabric sliding contact surface combination .....                      | 56        |
| Maintenance-free steel/PTFE FRP sliding contact surface combination .....                         | 59        |
| Variable load and sliding velocity .....  | 61        |
| Calculation examples.....   | 62        |
| <b>Friction .....</b>   | <b>69</b> |
| <b>Design of bearing arrangements .....</b>   | <b>70</b> |
| Radial location of bearings.....  | 70        |
| Axial location of bearings .....  | 75        |
| Located bearings .....  | 75        |
| Non-located bearings.....   | 75        |
| Abutment and fillet dimensions .....  | 77        |

|  |           |
|--|-----------|
| Location of rod ends .....   | 78        |
| Sealing .....  | 79        |
| Designing a bearing arrangement for easy mounting and dismantling .....                  | 82        |
| <b>Lubrication .....</b>   | <b>84</b> |
| The SKF traffic light concept .....  | 84        |
| Spherical plain bearings requiring maintenance .....                                     | 86        |
| Maintenance-free spherical plain bearings .....  | 88        |
| Steel/PTFE sintered bronze and steel/PTFE fabric sliding contact surface combinations .. | 88        |
| Steel/PTFE FRP sliding contact surface combination .....                                 | 88        |
| Rod ends requiring maintenance .....   | 89        |
| Maintenance-free rod ends .....  | 89        |
| <b>Relubrication .....</b>   | <b>90</b> |
| <b>Mounting .....</b>  | <b>92</b> |
| Spherical plain bearings .....   | 92        |
| Mechanical mounting .....  | 92        |
| Hot mounting .....   | 94        |
| Rod ends .....   | 95        |
| <b>Dismounting .....</b>   | <b>96</b> |
| Spherical plain bearings .....   | 96        |
| Rod ends .....   | 96        |

# Selection of bearing type

## Bearing terminology

To better understand frequently used plain bearing and rod end specific terms, definitions are provided in **fig. 1** and **fig. 2**.

### Spherical plain bearing

- 1 Outer ring
- 2 Sliding contact surfaces
- 3 Seal
- 4 Inner ring
- 5 Lubrication hole
- 6 Lubrication groove

### Rod end

- 1 Spherical plain bearing
- 2 Rod end
  - 2a Rod end housing
  - 2b Rod end shank, with an external (male) thread. Shanks are also available with an internal (female) thread or with a welding shank.
- 3 Grease fitting

Fig. 1

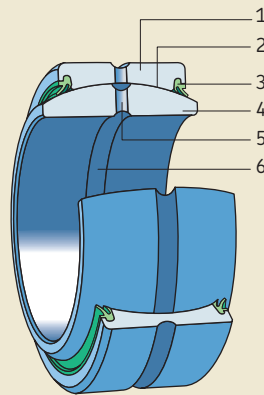
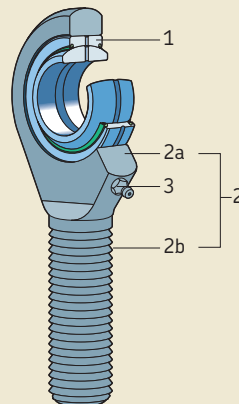

Fig. 2



## Bearing types

All the products listed below belong to the SKF standard assortment:

- radial spherical plain bearings requiring maintenance
- maintenance-free radial spherical plain bearings
- angular contact spherical plain bearings
- thrust spherical plain bearings
- steel/steel and steel/bronze rod ends requiring maintenance
- maintenance-free rod ends

If the standard assortment does not meet the requirements of an application, SKF can produce special bearings or rod ends, provided quantities are sufficient to enable manufacturing economy.

### Radial spherical plain bearings requiring maintenance

See chapter 2 starting on **page 99**

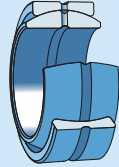
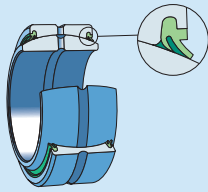
| Bearing design<br>Radial spherical plain bearings requiring maintenance  | Designation/<br>bore diameter range   | Characteristics   |
|--|---|---|
| <b>Sliding contact surface combination: Steel/steel</b><br>Suitable for heavy static or alternating loads, shock loads |   |   |
|                                      | <b>GE .. E</b><br>d = 4 – 12 mm   | Open (without seals), can only be relubricated from the side  |
|                                     | <b>GE .. ES</b><br>d = 15 – 200 mm<br><br><b>GEZ .. ES</b><br>d = 0,5 – 6 in          | Open (without seals), can be relubricated via lubrication holes and an annular groove in both rings                 |
|                                     | <b>GE .. ES-2RS</b><br>d = 15 – 300 mm<br><br><b>GEZ .. ES-2RS</b><br>d = 0,75 – 6 in | With a double-lip seal on both sides, can be relubricated via lubrication holes and an annular groove in both rings |

**Bearing design**

Radial spherical plain bearings requiring maintenance

**Designation/**

bore diameter range

**Characteristics****Sliding contact surface combination: Steel/steel**

Suitable for heavy static or alternating loads, shock loads

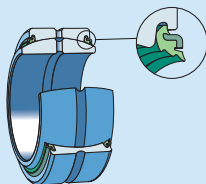
**GE .. ES-2LS**  
d = 20 – 300 mm**GEZ .. ES-2LS**  
d = 1 – 6 in

With a triple-lip heavy-duty seal on both sides, can be relubricated via lubrication holes and an annular groove in both rings

**GEH .. ES**  
upon request**GEZH .. ES**  
d = 1.25 – 5.5 in

Open (not sealed); wider inner ring and larger outside diameter compared to GE .. ES and GEZ .. ES series, to enable higher load ratings and larger tilt angle; can be relubricated via lubrication holes and an annular groove in both rings

**GEH .. ES-2RS**  
d = 20 – 120 mm**GEZH .. ES-2RS**  
d = 1.25 – 5.5 in

With a double-lip seal on both sides; wider inner ring and larger outside diameter compared to GE .. ES-2RS and GEZ .. ES-2RS series, to enable higher load ratings and larger tilt angle; can be relubricated via lubrication holes and an annular groove in both rings

**GEH .. ES-2LS**  
d = 20 – 120 mm**GEZH .. ES-2LS**  
d = 1.25 – 5.5 in

With a triple-lip heavy-duty seal on both sides; wider inner ring and larger outside diameter compared to GE .. ES-2RS and GEZ .. ES-2RS series, to enable higher load ratings and larger tilt angle; can be relubricated via lubrication holes and an annular groove in both rings

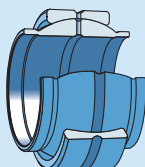
**GEM .. ES**  
upon request**GEZM .. ES**  
d = 0.5 – 6 in

Open (without seals); with an extended inner ring on both sides; can be relubricated via lubrication holes and an annular groove in both rings. For bearing arrangements where a spacer sleeve is normally incorporated on both sides of the inner ring.

**GEG .. ES**  
d = 16 – 200 mm**GEG series** : The inner ring width equals the bore diameter**GEG 12 ESA**  
d = 12 mm

Can only be relubricated via the outer ring

## Selection of bearing types

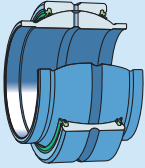
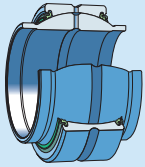
| Bearing design   | Designation/<br>bore diameter range  | Characteristics   |
|--|--|---|
| <b>Sliding contact surface combination: Steel/steel</b><br>Suitable for heavy static or alternating loads, shock loads |  |   |
|                                       | <b>GEM .. ES-2RS</b><br>d = 20 – 80 mm<br><br><b>GEZM .. ES-2RS</b><br>d = 0.75 – 6 in | With a double-lip seal and an extended inner ring on both sides, can be relubricated via lubrication holes and an annular groove in both rings            |
|                                       | <b>GEM .. ES-2LS</b><br>d = 20 – 80 mm<br><br><b>GEZM .. ES-2LS</b><br>d = 1 – 6 in    | With a triple-lip heavy-duty seal and an extended inner ring on both sides, can be relubricated via lubrication holes and an annular groove in both rings |

## Maintenance-free radial spherical plain bearings

See chapter 3 starting on **page 125**

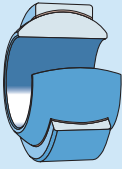
| Bearing design  | Designation/<br>bore diameter range                                       | Characteristics   |
|---|---|---|
| <b>Sliding contact surface combination: Steel/PTFE sintered bronze</b><br>Suitable for heavy, constant direction loads, where low friction is required; limited suitability for alternating loads, shock loads. |   |   |
|    | <b>GE .. C</b><br>d = 4 – 30 mm<br><br><b>GE .. CJ2</b><br>d = 35 – 60 mm | Open (without seals), self-lubricating sliding surfaces have to be externally protected from contaminants   |
|    | <b>GEH .. C</b><br>d = 10 – 25 mm   | Open (without seals), self-lubricating sliding surfaces have to be externally protected from contaminants; wider inner ring and larger outside diameter compared to GE .. C series, to enable higher load ratings and larger tilt angle |



**Bearing design**

Maintenance-free radial spherical plain bearings

**Designation/**

bore diameter range

**Characteristics****Sliding contact surface combination: Steel/PTFE fabric**

Suitable for very heavy, constant direction loads, where low friction is required; limited suitability for alternating loads, shock loads

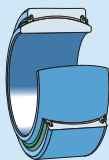
**GE .. TXE-2LS**  
d = 20 – 90 mm**GEZ .. TXE-2LS**  
d = 1 – 3.75 in**GE .. TXG3E-2LS**  
d = 20 – 60 mm

High performance bearing with a triple-lip heavy-duty seal on both sides, outer ring fractured at one point, self-lubricating sliding surfaces

GE .. TXG3E-2LS series in stainless steel execution for use in corrosive environments

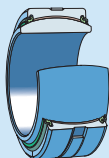
**GE .. TXA-2LS**  
d = 100 – 300 mm**GEZ .. TXA-2LS**  
d = 4 – 6 in**GE .. TXG3A-2LS**  
d = 70 – 200 mm

High performance bearing with a triple-lip heavy-duty seal on both sides, axially split outer ring that is held together by one band, self-lubricating sliding surfaces

GE .. TXG3A-2LS series with rings made of stainless steel for use in corrosive environments

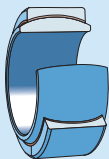
**GE .. TXGR**  
d = 12 – 17 mm

Open (without seals), stainless steel execution for use in corrosive environments, self-lubricating sliding surfaces have to be externally protected from contaminants

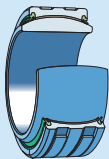
**GEC .. TXA-2RS**  
d = 320 – 400 mm

High performance bearing with a double-lip seal on both sides, self-lubricating sliding surfaces, axially split outer ring that is held together by two bands

**GEC .. TXA-2RS**  
d = 420 – 800 mm

High performance bearing with a double-lip seal on both sides, self-lubricating sliding surfaces, axially split outer ring that is bolted together

## Selection of bearing types

### Bearing design

Maintenance-free radial spherical plain bearings

### Designation/

bore diameter range

### Characteristics

#### Sliding contact surface combination: Steel/PTFE fabric

Suitable for very heavy, constant direction loads, where low friction is required; limited suitability for alternating loads, shock loads

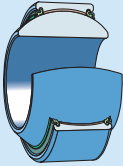

**GEH ..TXE-2LS**  
d = 20 – 80 mm

High performance bearing with a triple-lip heavy-duty seal on both sides; self-lubricating sliding surfaces, wider inner ring and larger outside diameter compared to GE .. TXE-2LS series, to enable higher load ratings and larger tilt angle

**GEH ..TXG3E-2LS**  
d = 20 – 50 mm

GEH .. TXG3E-2LS series with rings made of stainless steel for use in corrosive environments

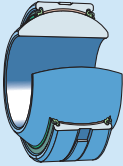

**GEH ..TXA-2LS**  
d = 90 – 120 mm

High performance bearing with a triple-lip heavy-duty seal on both sides, self-lubricating sliding surfaces, wider inner ring and larger outside diameter compared to GE .. TXE-2LS series, to enable higher load ratings and larger tilt angle; axially split outer ring that is held together by one band

**GEH ..TXG3A-2LS**  
d = 60 – 120 mm

GEH .. TXG3A-2LS series with rings made of stainless steel for use in corrosive environments

#### Sliding contact surface combination: Steel/PTFE FRP

Suitable for heavy, constant direction loads, where low friction is required; limited suitability for alternating loads, shock loads; relatively insensitive to contaminants

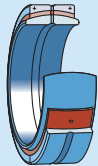

**GEC .. FBAS**  
d = 320 – 1 000 mm

Open (without seals); axially split outer ring that is bolted together; self-lubricating capability; factory greased; lubrication holes and an annular groove in both rings; does not require relubrication, however, relubrication can extend bearing service life

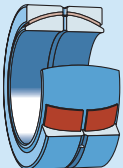

**GEP .. FS**  
d = 100 – 1 000 mm

Open (without seals); radially split outer ring that is separable to facilitate mounting; self-lubricating capability; factory greased; lubrication holes and an annular groove in both rings; does not require relubrication, however, relubrication can extend bearing service life

Compared to GEC .. FBAS series, these bearings are wider and have a larger outside diameter for a given shaft size, resulting in a higher basic load rating. However, they have a smaller tilt angle.

## Angular contact spherical plain bearings

See chapter 4 starting on **page 151**

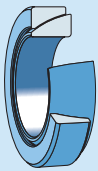
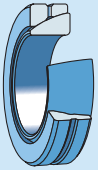
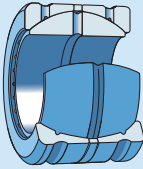
| Bearing design<br>Angular contact spherical plain bearings   | Designation/<br>bore diameter range  | Characteristics   |
|--|--|---|
| <p><b>Sliding contact surface combination: Steel/PTFE FRP</b><br/>Suitable for single direction axial loads or combined axial and radial loads, low coefficient of friction, relatively insensitive to contaminants</p>  | <p><b>GAC .. F</b><br/>d = 25 – 120 mm</p>   | <p>Open (without seals); self-lubricating capability; factory greased; does not require relubrication, however, relubrication can extend bearing service life</p> |
|   |  |   |
| <p><b>Sliding contact surface combination: Steel/PTFE fabric</b><br/>Suitable for single direction axial loads or combined axial and radial loads, very high load carrying capacity and low coefficient of friction</p>  | <p><b>GACD .. TX</b><br/>upon request</p>  | <p>Open (without seals), high performance bearing with self-lubricating sliding surface</p>   |
|   |  |   |
| <p><b>Sliding contact surface combination: Steel/steel</b><br/>Suitable for heavy single direction axial loads or heavy combined axial and radial loads, heavy alternating loads</p>   | <p><b>GACD .. SA</b><br/>upon request</p> <p><b>GAZ .. SA</b><br/>upon request</p> | <p>Open (without seals), multi-groove system, can be relubricated via lubrication holes and an annular groove in the outer ring</p>                               |
|    |  |   |
| <p><b>Sliding contact surface combination: Steel/steel</b><br/>Double direction angular contact bearing with a standard inner ring, bearing can be used instead of two angular contact bearings in a face-to-face arrangement, suitable for heavy combined radial and axial loads, heavy alternating loads</p> | <p><b>GEZP(R) .. S</b><br/>upon request</p>  | <p>Open (without seals), multi-groove system, can be relubricated via lubrication holes and an annular groove in the inner ring and the two outer rings</p>       |
|   |  |   |

## Selection of bearing types

### Thrust spherical plain bearings

See chapter 5 starting on **page 159**

| Bearing design  | Designation/<br>bore diameter range | Characteristics  |
|---|-------------------------------------|--|
| <b>Thrust spherical plain bearings</b><br><b>Sliding contact surface combination: Steel/PTFE FRP</b><br>Suitable for single direction axial loads or combined axial and radial loads, low coefficient of friction, relatively insensitive to contaminants | <b>GX .. F</b><br>d = 17 – 120 mm   | Open (without seals); self-lubricating capability; factory greased; does not require relubrication, however, relubrication can extend bearing service life |
| <b>Sliding contact surface combination: Steel/PTFE fabric</b><br>Suitable for heavy single direction axial loads or combined axial and radial loads, very high load carrying capacity and low coefficient of friction                                     | <b>GXD .. TX</b><br>upon request    | Open (without seals), high performance bearing with self-lubricating sliding surface   |
| <b>Sliding contact surface combination: Steel/steel</b><br>Suitable for heavy single direction axial loads or combined axial and radial loads, heavy alternating loads  | <b>GXD .. SA</b><br>upon request    | Open (without seals), multi-groove system, can be relubricated via lubrication holes and an annular groove in the housing washer                           |

### Rod ends with a threaded shank, requiring maintenance

See chapter 6 starting on **page 167**

| Bearing design   | Designation/<br>bore diameter range  | Characteristics   |
|--|--|---|
| <b>Rod ends with a threaded shank, requiring maintenance</b><br><b>Sliding contact surface combination: Steel/steel</b><br>Suitable for heavy static or alternating loads, shock loads | <b>SI(L) .. E</b><br>d = 6 – 12 mm<br><br><b>SA(L) .. E</b><br>d = 6 – 12 mm | With an open bearing (without seals), no relubrication facilities, available with a right-hand or left-hand thread (designation prefix L) |

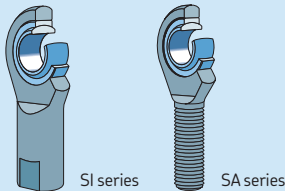

**Bearing design**

Rod ends with a threaded shank, requiring maintenance

**Designation/**

bore diameter range

**Characteristics****Sliding contact surface combination: Steel/steel**

Suitable for heavy static or alternating loads, shock loads



SI series

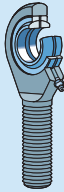

SA series

**SI(L) .. ES**

d = 15 – 30 mm

**SA(L) .. ES**

d = 15 – 30 mm

With an open bearing (without seals), can be lubricated via the relubrication facility in the rod end housing and via the pin (shaft), available with a right-hand or left-hand thread

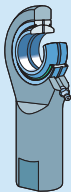

SI(A) series

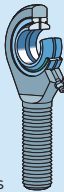

SA(A) series

**SI(L) .. ES-2RS**

d = 35 – 80 mm

**SA(L) .. ES-2RS**

d = 35 – 80 mm

**SI(L)A .. ES-2RS**

d = 40 – 80 mm

**SA(L)A .. ES-2RS**

d = 40 – 80 mm

With a double-lip seal on both sides of the bearing, can be lubricated via the relubrication facility in the rod end housing and via the pin (shaft), available with a right-hand or left-hand thread

SI(A) and SAA series with different fitting dimensions (thread, height of the housing)

**Sliding contact surface combination: Steel/steel**

Suitable for hydraulic cylinders, the slotted shank enables the rod end to be secured by tightening bolts

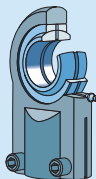
**SI(L)J .. ES**

d = 16 – 100 mm

With an open bearing (without seals), available with a right-hand or left-hand thread

Sizes 16 and larger can be lubricated via the relubrication facility in the rod end housing and via the pin (shaft)

**SI(L)J 12 E**

d = 12 mm

No relubrication facilities

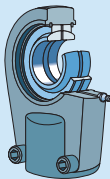
**SI(L)R .. ES**

d = 25 – 120 mm

With an open bearing (without seals), compact design, shorter female thread, can be lubricated via the relubrication facility in the rod end housing and via the pin (shaft), available with a right-hand or left-hand thread

**SI(L)QG .. ES**

d = 16 – 200 mm

With an open bearing (without seals), with an inner ring extended on both sides, can be lubricated via the relubrication facility in the rod end housing and via the pin (shaft), available with a right-hand or left-hand thread

**SI(L)QG 12 ESA**

d = 12 mm

Can only be lubricated via the relubrication facilities in the rod end housing

## Selection of bearing types

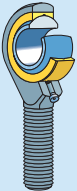
| Bearing design<br>Rod ends with a threaded shank, requiring maintenance  | Designation/<br>bore diameter range             | Characteristics   |
|--|---|---|
| <b>Sliding contact surface combination: Steel/bronze</b><br>Lower load carrying capacity compared to steel/steel rod ends, but more suitable for applications where lubricant starvation might occur |   |   |
|   | <b>SI(L)KAC .. M</b><br>$d = 5 - 30 \text{ mm}$ | With an open bearing (without seals), available with a right-hand or left-hand thread               |
|   | <b>SA(L)KAC .. M</b><br>$d = 5 - 30 \text{ mm}$ | Sizes 6 and larger can be lubricated via the relubrication facility in the rod end shank or housing |
| SIKAC .. M   | SAKAC .. M                                      |   |

## Rod ends with a welding shank, requiring maintenance

See chapter 6 starting on **page 167**

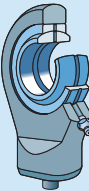
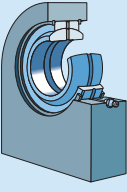
| Bearing design<br>Rod ends with a welding shank, requiring maintenance   | Designation/<br>bore diameter range          | Characteristics  |
|--|--|--|
| <b>Sliding contact surface combination: Steel/steel</b><br>Suitable for heavy static or alternating loads, shock loads |  |  |
|                                      | <b>SC ..ES</b><br>$d = 20 - 80 \text{ mm}$   | With an open bearing (without seals), can be lubricated via a the relubrication facility in the rod end housing and via the pin (shaft)<br><br>Primarily used for welding to piston rods and the bases of hydraulic cylinders<br><br>Centred by a dowel pin                              |
|                                     | <b>SCF ..ES</b><br>$d = 20 - 120 \text{ mm}$ | With an open bearing (without seals); can be lubricated via the the relubrication facility in the rod end housing and via the pin (shaft); high capacity design rod end compared to SC .. ES series, to enable heavier static loads<br><br>Rectangular welding shank without a dowel pin |

## Maintenance-free rod ends with a threaded shank

See chapter 7 starting on **page 189**

### Bearing design

Maintenance-free rod ends with a threaded shank

### Designation/ bore diameter range

### Characteristics

#### Sliding contact surface combination: Steel/PTFE sintered bronze

Suitable for heavy, constant direction loads, where low coefficient of friction is required; limited suitability for alternating loads, shock loads



SI..C



SA..C

SI(L) .. C

d = 6 – 30 mm

SA(L) .. C

d = 6 – 30 mm

With an open bearing (without seals), available with a right-hand or left-hand thread

#### Sliding contact surface combination: Steel/PTFE fabric

Suitable for very heavy, constant direction loads, where low coefficient of friction is required; limited suitability for alternating loads, shock loads



SI(A) .. TXE-2LS



SA(A) .. TXE-2LS

SI(L) .. TXE-2LS

d = 35 – 80 mm

SA(L) .. TXE-2LS

d = 35 – 80 mm

SI(L)A .. TXE-2LS

d = 40 – 60 mm

SA(L)A .. TXE-2LS

d = 40 – 60 mm

With a high performance bearing with a triple-lip heavy-duty seal on both sides of the bearing, available with a right-hand or left-hand thread

SI(A) and SAA series with different fitting dimensions (thread, height of the housing)

#### Sliding contact surface combination: Steel/PTFE FRP

Suitable for heavy, constant direction loads, where low coefficient of friction is required; limited suitability for alternating loads, shock loads



SIKB .. F



SAKB .. F

SI(L)KB .. F

d = 5 – 22 mm

SA(L)KB .. F

d = 5 – 22 mm

With an open bearing (without seals), but relatively insensitive to contaminants, available with a right-hand or left-hand thread

# Selection of bearing size

## Load ratings

There is no standardized method for determining the load ratings of spherical plain bearings and rod ends, nor is there any standardized definition. As different manufacturers define load ratings differently, it is not possible to compare the load ratings of bearings produced by one manufacturer with those of another.

### Basic dynamic load rating

The basic dynamic load rating  $C$  is used, together with other influencing factors, to determine the basic rating life of spherical plain bearings and rod ends. As a rule, it represents the maximum load that a spherical plain bearing or rod end can accommodate at room temperature when there is movement between the sliding contact surfaces (→ **fig. 1**). The maximum load in any application should always be considered in relation to the required rating life. The basic dynamic load ratings quoted in the product tables are based on the specific load factor  $K$  (→ **table 4** on **page 45**) and the effective projected sliding surface.

### Basic static load rating

The basic static load rating  $C_0$  represents the maximum permissible load that a spherical plain bearing or rod end can accommodate when there is no relative movement between the sliding contact surfaces (→ **fig. 2**).

For spherical plain bearings, the basic static load rating represents the maximum load that the bearing can accommodate at room temperature without inadmissible deforming, fracturing or damaging the sliding contact surfaces.

The basic static load ratings quoted for SKF spherical plain bearings are based on a specific

Fig. 1

Dynamic bearing load

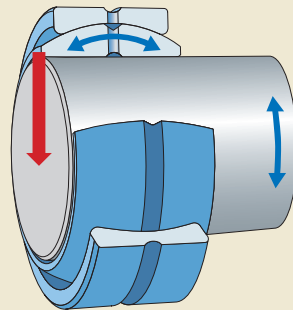
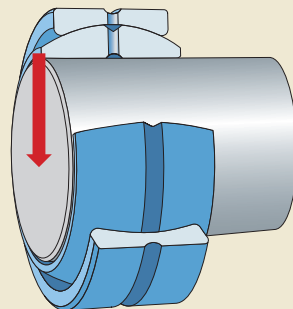

Fig. 2

Static bearing load





## Angle of oscillation

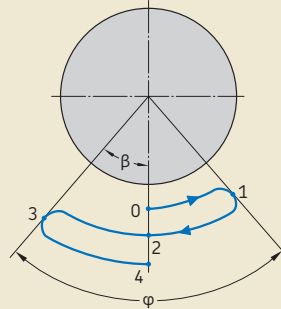

$\varphi$  = angle of oscillation =  $2\beta$   
A complete oscillation is from point 0 to point 4 and =  $4\beta$

static load factor  $K_0$  (→ table 4 on page 45) and the effective projected sliding surface. It is assumed that the bearing is adequately supported. To fully exploit the static load rating of a spherical plain bearing, it is generally necessary to use shafts and housings made of high-strength materials. The basic static load rating must also be considered when bearings are dynamically loaded and subjected to additional heavy shock loads. The total load in these cases must not exceed the basic static load rating.

For rod ends, it is the strength of the housing at room temperature, under a constant load acting in the direction of the shank axis, that is the determining factor. The basic static load rating represents a safety factor of at least 1,2 relative to the yield strength of the material of the rod end housing, under the above conditions.

## Basic rating life

For spherical plain bearings, a lubricant film that fully separates the sliding contact surfaces cannot be formed. Therefore, the sliding contact surfaces make direct contact with each other, resulting in a certain and unavoidable degree of wear. This increases the internal clearance in the bearing.

Regarding the life of spherical plain bearings or rod ends, a distinction is made between the basic rating life and the service life. The basic rating life is a theoretical guideline value, used to estimate the service life. Service life depends on the actual operating conditions and is the actual life achieved by the bearing in service.

The basic rating life is based on a large number of laboratory tests. The bearings were tested for an operating period until a specific increase in bearing clearance or friction occurred (→ table 1 on page 40). The basic rating life considers several influencing factors and can be expressed in operating hours or the number of oscillating movements (→ fig. 3). In some cases, however, it is not possible to quantify factors such as contamination, corrosion, and complex kinematic loads. Therefore, the basic rating life can be attained or exceeded by

the majority of many apparently identical spherical plain bearings under the same operating conditions. For the calculation methods of the different sliding contact surface combinations as well as calculation examples, refer to the section *Basic rating life calculation* starting on page 51.

The service life cannot be calculated as it is too complex to determine and evaluate all the influencing factors. Therefore, depending on the application conditions, the service life may differ from the basic rating life.

**NOTE:** By using the *SKF Interactive Engineering Catalogue* and its incorporated calculation programs, it is possible to perform the necessary calculations to select a spherical plain bearing with the click of a mouse. The product data necessary for the calculations is automatically put in by selecting a spherical plain bearing or rod end from the product tables. It is then only necessary to fill in the fields for the operating data.

The *SKF Interactive Engineering Catalogue* is available online at [www.skf.com](http://www.skf.com).

## Selection of bearing size

Table 1

### Failure criteria for basic rating life tests

| Sliding contact surface combination            | Increase in bearing clearance | Coefficient of friction $\mu$ |
|--|-------------------------------|-------------------------------|
| –  | mm                            | –                             |
| <b>Steel/steel</b>                             | $> 0,004 d_k^{1)}$            | 0,20                          |
| <b>Steel/bronze</b>                            | $> 0,004 d_k^{1)}$            | 0,25                          |
| <b>Steel/PTFE<sup>2)</sup> sintered bronze</b> |                               |                               |
| constant direction load                        | 0,2                           | 0,25                          |
| alternating direction load                     | 0,4                           | 0,25                          |
| <b>Steel/PTFE fabric</b>                       |                               |                               |
| constant direction load                        | 0,3                           | 0,15                          |
| alternating direction load                     | 0,6                           | 0,15                          |
| <b>Steel/PTFE FRP<sup>3)</sup></b>             | design and size dependent     | 0,20                          |

<sup>1)</sup>  $d_k$  = sphere diameter of the inner ring.

<sup>2)</sup> Polytetrafluoroethylene.

<sup>3)</sup> Fibre reinforced polymer.

Fig. 4

Radial load

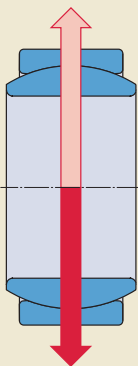

Fig. 5

Axial load

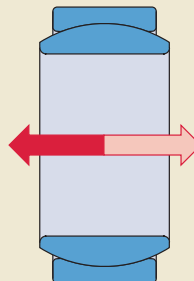

Fig. 6

## Combined load

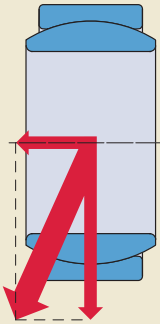

Fig. 7

## Constant direction load

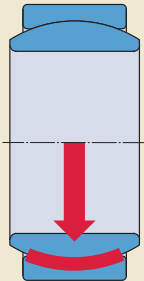
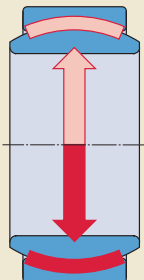

Fig. 8

## Alternating direction load



## Load

When considering load, a distinction is made between:

- load direction
  - radial load (→ **fig. 4**)
  - axial load (→ **fig. 5**)
  - combined (axial and radial) load (→ **fig. 6**)
- type of load
  - dynamic load, i.e. there is relative sliding movement in the loaded bearing
  - static load, i.e. there is no relative movement in the loaded bearing
- load conditions
  - constant load (→ **fig. 7**), i.e. the direction in which the load is applied does not change and the same part of the bearing (loaded zone) is always subjected to the load
  - alternating load (→ **fig. 8**), i.e. change of load direction so that zones at opposite positions in the bearing are alternately loaded and unloaded

### Equivalent dynamic bearing load

The load can be inserted directly into the equation for the specific bearing load  $p$  (→ **page 46**) if the magnitude of the load is constant and if the load acting on:

- radial and angular contact spherical plain bearings is purely radial
- thrust spherical plain bearings is purely axial
- rod ends is purely radial and in the direction of the shank axis

In all other cases it is necessary to calculate the equivalent dynamic bearing load  $P$ . If the magnitude of the load is not constant, use the equation provided in the section *Variable load and sliding velocity* (→ **page 61**).

## Selection of bearing size

### Radial spherical plain bearings

Radial spherical plain bearings can accommodate a certain magnitude of axial load  $F_a$  in addition to a simultaneously acting radial load  $F_r$  (→ **fig. 6 on page 41**). When the resultant load is constant in magnitude, the equivalent dynamic bearing load can be calculated using

$$P = y F_r$$

where

$P$  = equivalent dynamic bearing load [kN]

$F_r$  = radial component of the load [kN]

$y$  = load factor that depends on the ratio of the axial to the radial load  $F_a/F_r$

– for bearings requiring maintenance

(→ **diagram 1**)

– for maintenance-free bearings

(→ **diagram 2**)

Diagram 1

Factor  $y$  for radial spherical plain bearings requiring maintenance

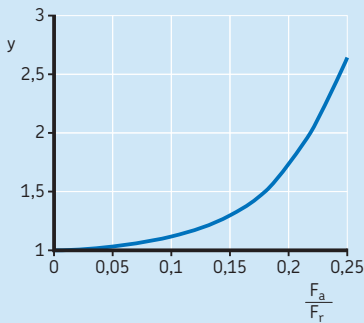

Diagram 2

Factor  $y$  for maintenance-free radial spherical plain bearings

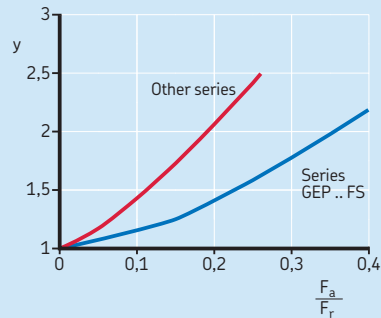
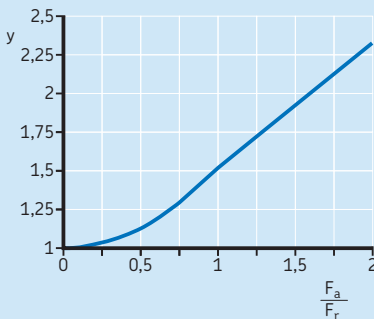

Diagram 3

Factor  $y$  for angular contact spherical plain bearings



If  $F_a/F_r > 2$ , use a thrust spherical plain bearing instead, or contact the SKF application engineering service.

Diagram 4

Factor  $y$  for thrust spherical plain bearings

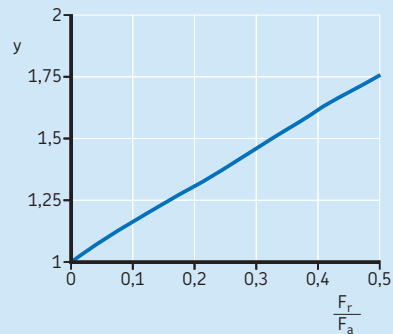

If  $F_r/F_a > 0.5$ , use an angular contact spherical plain bearing instead, or contact the SKF application engineering service.

### Angular contact spherical plain bearings

When the resultant load ( $\rightarrow$  **fig. 9**) is constant in magnitude, then use

$$P = y F_r$$

where

$P$  = equivalent dynamic bearing load [kN]  
 $F_r$  = radial component of the load [kN]  
 $y$  = load factor that depends on the ratio of the axial to the radial load  $F_a/F_r$  ( $\rightarrow$  **diagram 3**)

### Thrust spherical plain bearings

Thrust spherical plain bearings can accommodate a radial load  $F_r$  in addition to an axial load  $F_a$  ( $\rightarrow$  **fig. 10**). However, the radial load must not exceed 50% of the simultaneously acting axial load. When the resultant load is constant in magnitude, then use

$$P = y F_a$$

where

$P$  = equivalent dynamic bearing load [kN]  
 $F_a$  = axial component of the load [kN]  
 $y$  = load factor depending on the ratio of the radial to the axial load  $F_r/F_a$   
 ( $\rightarrow$  **diagram 4**)

### Equivalent static bearing load

If spherical plain bearings and rod ends are subjected to static loads, or very slight alignment movements, then the permissible load is not limited by wear, but by the strength of the sliding contact layer or the strength of the rod end housing.

If the actual load is a combined load, then an equivalent static bearing load must be calculated. For radial and angular contact spherical plain bearings, it can be calculated using

$$P_0 = y F_r$$

For thrust spherical plain bearings, it can be calculated using

$$P_0 = y F_a$$

Fig. 9

Angular contact spherical plain bearing under combined load

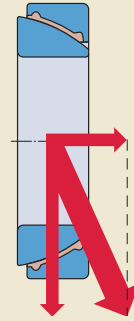
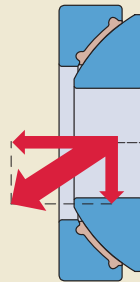

Fig. 10

Thrust spherical plain bearing under combined load



where

$P_0$  = equivalent static bearing load [kN]  
 $F_r$  = radial component of the load [kN]  
 $F_a$  = axial component of the load [kN]  
 $y$  = load factor that depends on the ratio of the axial to the radial load  $F_a/F_r$   
 – for radial bearings requiring maintenance ( $\rightarrow$  **diagram 1**)  
 – for maintenance-free radial bearings ( $\rightarrow$  **diagram 2**)  
 – for angular contact spherical plain bearings ( $\rightarrow$  **diagram 3**)  
 and load factor that depends on the ratio of the radial to the axial load  $F_r/F_a$   
 – for thrust spherical plain bearings ( $\rightarrow$  **diagram 4**)

### Permissible loads for rod ends

Rod ends are primarily intended for the support of radial loads acting in the direction of the shank axis. If loads act at angles to the shank axis (→ **fig. 11**), the maximum permissible load is reduced, as additional bending stresses occur in the shank. Under these conditions, consider the design and size dependent material used for the rod end housing (→ **table 6** on **page 170**).

The load portion acting perpendicular to the direction of the shank axis should never exceed the value of 0,1 C<sub>0</sub>. If heavier loads are involved, a larger rod end should be selected.

The maximum permissible load for a rod end in the direction of the shank axis can be calculated using

$$P_{perm} = C_0 b_2 b_6$$

where

P<sub>perm</sub> = maximum permissible load [kN]

C<sub>0</sub> = static load rating [kN]

b<sub>2</sub> = temperature factor

- for rod ends requiring maintenance (→ **table 5** on **page 52**)
- for maintenance-free rod ends with the sliding contact surface combination
  - steel/PTFE sintered bronze (→ **diagram 16** on **page 55**)
  - steel/PTFE fabric (→ **diagram 17** on **page 56**)
  - steel PTFE FRP (→ **diagram 19** on **page 59**)

b<sub>6</sub> = factor for the type of load (→ **table 2**)

Fig. 11

Rod end under combined load

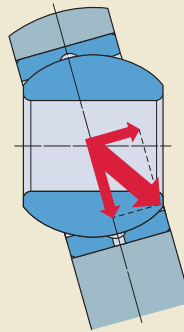

Table 2

Factor b<sub>6</sub> for rod end load type

| Type of load                           | Factor b <sub>6</sub> |
|--|-----------------------|
| Constant                               | 1                     |
| Pulsating magnitude (single direction) | 0,5<br>(0,35)         |
| Alternating direction                  | 0,5<br>(0,35)         |

The values in brackets apply to rod ends with a relubrication facility.

## Requisite bearing size

To determine the requisite size of a spherical plain bearing or rod end, it is necessary to know the requisite rating life for the application. This depends on the type of machine, the operating conditions and the demands regarding operational reliability. The following steps can be used to determine requisite bearing size:

- 1 Use the guideline values of the load ratio  $C/P$  provided in **table 3** to obtain a requisite basic dynamic load rating  $C$ . Compare this value with the basic dynamic load rating of the bearings listed in the product tables.
- 2 Use **diagrams 5 to 10** on **pages 46 to 50** to check whether the sliding contact surface combination of the selected bearing or rod end can be used under the actual load  $p$  and sliding velocity  $v$  conditions. The specific bearing load  $p$  and the sliding velocity  $v$  needed to perform this check can be calculated as explained in the following sections:
  - a) If the  $p$  $v$  diagram indicates that the basic rating life equation can be used, proceed to step 3.
  - b) If the  $p$  $v$  diagram shows that the  $p$  $v$  range is exceeded, select a bearing with a higher load carrying capacity.
- 3 Calculate the basic rating life (**→ page 51**) and proceed as follows:
  - a) If the calculated rating life is shorter than the requisite rating life, a larger bearing or rod end should be selected and the calculation repeated.
  - b) If the calculated rating life is larger than the requisite rating life, the bearing or rod end can be selected for the application.

The bearing or rod end size is often determined by the dimensions of the associated components. In these cases, check the  $p$  $v$  diagram to determine if the product is suitable.

Table 3

| Guideline values for C/P            |                |
|-------------------------------------|----------------|
| Sliding contact surface combination | Load ratio C/P |
| Steel/steel                         | 2              |
| Steel/bronze                        | 2              |
| Steel/PTFE sintered bronze          | 1,6            |
| Steel/PTFE fabric                   | 2              |
| <b>Steel/PTFE FRP</b>               |                |
| GAC .. F                            | 1,25           |
| GX .. F                             | 1,25           |
| GEP .. FS                           | 1,6            |
| GEC .. FBAS                         | 1,6            |
| <b>Rod ends</b>                     | 1,25           |

Table 4

| Sliding contact surface combination | Specific load factors |                      |
|-------------------------------------|-----------------------|----------------------|
|                                     | dyn. K                | stat. K <sub>0</sub> |
| –                                   | N/mm <sup>2</sup>     |                      |
| <b>Steel/steel</b>                  |                       |                      |
| Metric bearings                     | 100                   | 500                  |
| Inch bearings                       | 100                   | 300                  |
| <b>Steel/bronze</b>                 | 50                    | 80                   |
| <b>Steel/PTFE sintered bronze</b>   | 100                   | 250                  |
| <b>Steel/PTFE fabric</b>            |                       |                      |
| Metric bearings                     | 300                   | 500                  |
| Inch bearings                       | 150                   | 300                  |
| <b>Steel/PTFE FRP</b>               |                       |                      |
| GAC .. F                            | 50                    | 80                   |
| GX .. F                             | 50                    | 80                   |
| GEP .. FS                           | 80                    | 120                  |
| GEC .. FBAS                         | 80                    | 120                  |
| <b>Rod ends</b>                     | 50                    | 80                   |

## Selection of bearing size

### Specific bearing load

The magnitude of the specific bearing load can be calculated using

$$p = K \frac{P}{C}$$

where

$p$  = specific bearing load [N/mm<sup>2</sup>]

$K$  = specific load factor depending on the bearing design and sliding contact surface combination (→ **table 4** on **page 45**) [N/mm<sup>2</sup>]

$P$  = equivalent dynamic bearing load [kN]

$C$  = basic dynamic load rating [kN]

### Mean sliding velocity

The mean sliding velocity for constant movement can be calculated using

$$v = 5,82 \times 10^{-7} d_m \beta f$$

where

$v$  = mean sliding velocity [m/s]

When the operation is intermittent (not continuous), the mean sliding velocity should be calculated for a cycle of operation

$d_m$  = inner ring mean diameter [mm]

$d_m = d_k$  for radial spherical plain bearings and rod ends

$d_m = 0,9 d_k$  for angular contact spherical plain bearings

$d_m = 0,7 d_k$  for thrust spherical plain bearings

$d_k$  = inner ring sphere diameter [mm]

$\beta$  = half the angle of oscillation (→ **fig. 3** on **page 39**), degrees [°], for rotation  $\beta = 90^\circ$

$f$  = frequency of oscillation [min<sup>-1</sup>], or rotational speed [min<sup>-1</sup>]

Diagram 5

pv diagram for steel/steel sliding contact surface combination

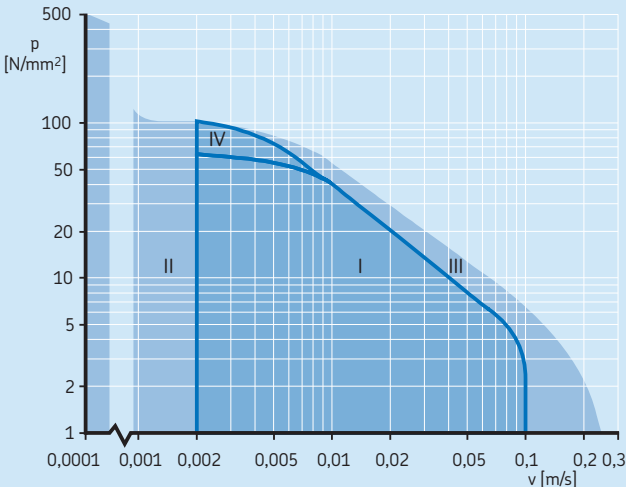

Refer to Note 1 (→ **page 47**) for explanation of operating ranges.



For intermittent movement, the angle of oscillation is usually given in units of time. In this case the mean sliding velocity can be calculated using

$$v = 8,73 \times 10^{-6} d_m \frac{4\beta}{t}$$

where

$\beta$  = half the angle of oscillation [°]

(→ fig. 3 on page 39)

t = time taken to pass through complete oscillation [s]

#### NOTE 1: pv operating ranges

- I Range where rating life equation is valid
- II Quasi-static range; before using the rating life equation, contact the SKF application engineering service
- III Possible range of use, e.g. with very good lubrication; before using the rating life equation, contact the SKF application engineering service for additional information
- IV Extended range where rating life equation is valid provided the load is exclusively alternating

Diagram 6

pv diagram for steel/bronze sliding contact surface combination

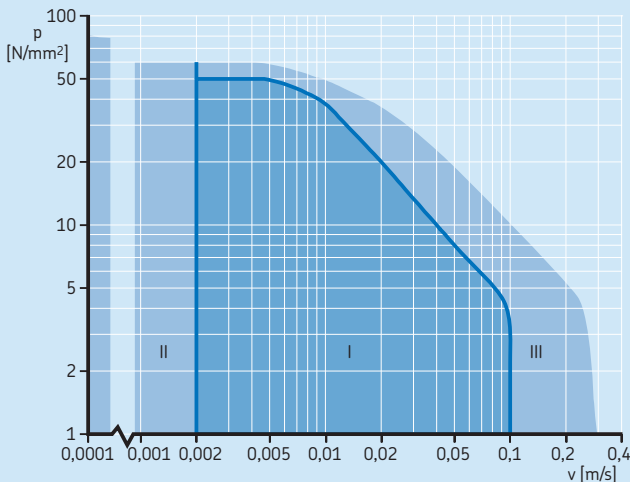

Refer to Note 1 for explanation of operating ranges.

## Selection of bearing size

### NOTE 2: pv operating ranges

- I Range where rating life equation is valid
- II Quasi-static range; rating life equation has limited validity, refer to the section *Basic rating life*, starting on **page 39**
- III Possible range of use, e.g. with very good heat dissipation; before using the rating life equation, contact the SKF application engineering service for additional information

Diagram 7

pv diagram for steel/PTFE sintered bronze sliding contact surface combination

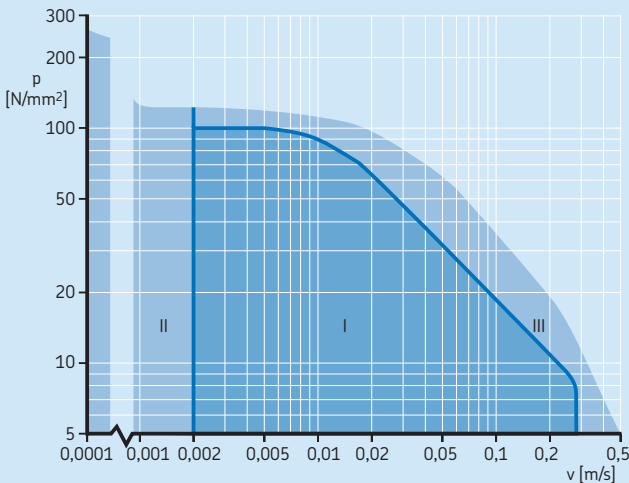

Refer to Note 2 for explanation of operating ranges.

## pv diagrams for steel/PTFE fabric sliding contact surface combination

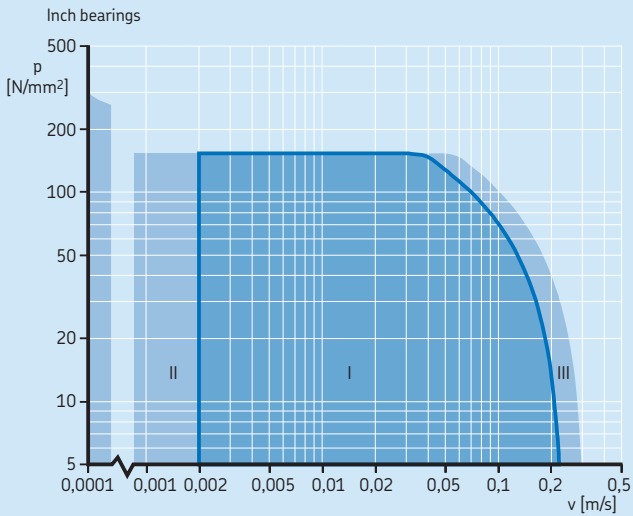
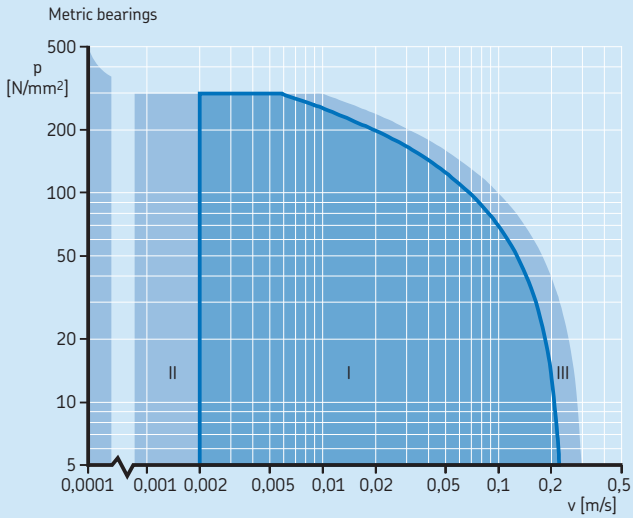

Refer to Note 2 (→ page 48) for explanation of operating ranges.

Diagram 9

pv diagram for steel/PTFE FRP sliding contact surface combination, FS and FBAS designs

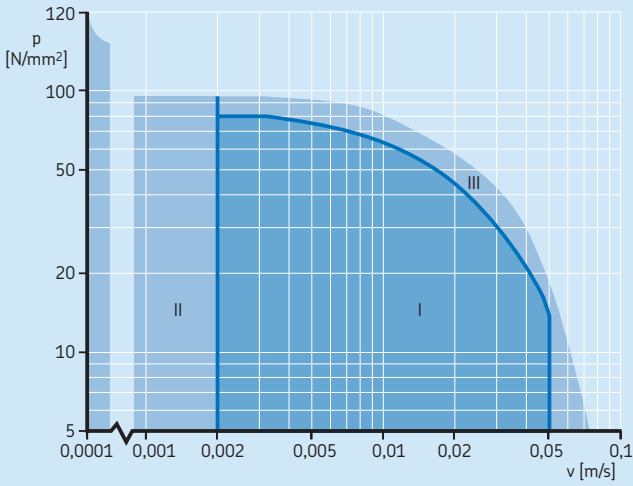

Refer to Note 2 (→ page 48) for explanation of operating ranges.

Diagram 10

pv diagram for steel/PTFE FRP sliding contact surface combination, F design

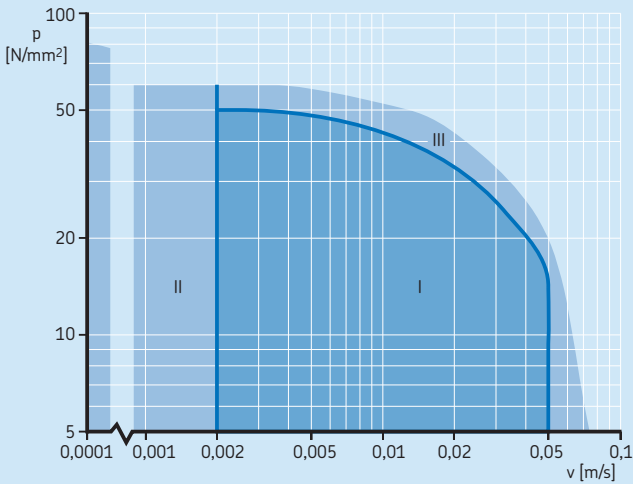

Refer to Note 2 (→ page 48) for explanation of operating ranges.

## Basic rating life calculation

### Steel/steel and steel/bronze sliding contact surface combinations, requiring maintenance

The basic rating life for initial lubrication only, can be calculated using

$$G_h = b_1 b_2 b_3 b_4 b_5 \frac{330}{p^{2.5} v}$$

When the bearing is regularly relubricated after the initial lubrication

$$G_{hN} = G_h f_\beta f_H$$

or

$$G_N = 60 f G_{hN}$$

The frequency of relubrication can be calculated using

$$H = \frac{G_h}{N}$$

where

$G_h$  = basic rating life with initial lubrication only, operating hours [h]

$G_{hN}$  = basic rating life with regular relubrication, operating hours [h]

$G_N$  = basic rating life with regular relubrication, number of oscillations

$H$  = frequency of relubrication (→ **diagram 15** on **page 53**)

$b_1$  = load condition factor,  
 $b_1 = 1$  for constant direction load  
 $b_1 = 2$  for alternating direction load

$b_2$  = temperature factor (→ **table 5** on **page 52**)

$b_3$  = sliding factor (→ **diagram 11**)

$b_4$  = velocity factor (→ **diagram 12** on **page 52**)

$b_5$  = factor for angle of oscillation  
(→ **diagram 13** on **page 52**), refer to *Note* (→ **page 53**)

$p$  = specific bearing load [ $\text{N}/\text{mm}^2$ ] (for values of  $p < 10 \text{ N}/\text{mm}^2$  use  $p = 10 \text{ N}/\text{mm}^2$ )

$v$  = mean sliding velocity [m/s]

$f_\beta$  = factor depending on the angle of oscillation (→ **diagram 14** on **page 53**), refer to *Note* (→ **page 53**)

$f_H$  = factor depending on the frequency of relubrication (→ **diagram 15** on **page 53**)

$f$  = frequency of oscillation [ $\text{min}^{-1}$ ]

$N$  = relubrication interval [h]

If the basic rating life requirement is not met, the relubrication interval  $N$  should be shortened, or a larger bearing or rod end should be selected.

Diagram 11

Sliding factor  $b_3$  for steel/steel and steel/bronze sliding contact surface combinations

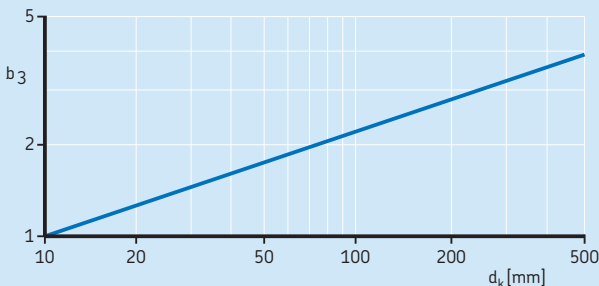

Velocity factor  $b_4$  for steel/steel and steel/bronze sliding contact surface combinations

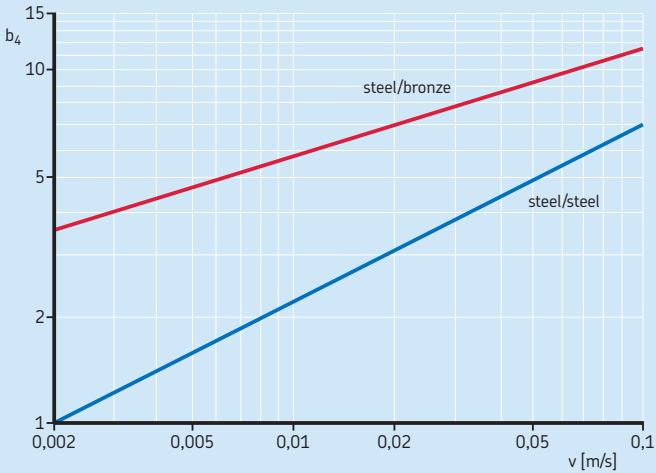

Table 5

Temperature factor  $b_2$  for steel/steel and steel/bronze sliding contact surface combinations

| Operating temperature |       | Temperature factor $b_2$                        |
|-----------------------|-------|---|
| over                  | incl. |   |
| °C                    | –     |   |
| –                     | 120   | 1,0   |
| 120                   | 160   | 0,9   |
| 160                   | 180   | 0,8   |
| 180                   | –     | Contact the SKF application engineering service |

The temperature limits for integral seals (→ table 6 on page 79) and SKF greases (→ table 1 on page 87) must also be considered.

Diagram 13

Angle of oscillation factor  $b_5$  for steel/steel and steel/bronze sliding contact surface combinations

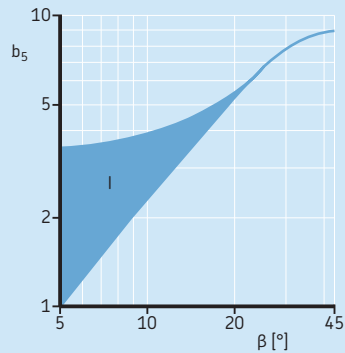

If  $\beta < 5^\circ$ , the value of  $b_5$  for  $\beta = 5^\circ$  should be used.

Diagram 14

Multiplication factor  $f_{\beta}$  for steel/steel and steel/bronze sliding contact surface combinations

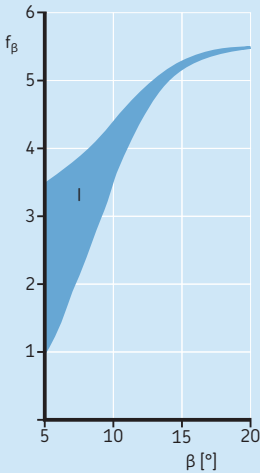

If  $\beta < 5^\circ$ , the value of  $f_{\beta}$  for  $\beta = 5^\circ$  should be used.

**NOTE:** SKF manufactures all metric steel/steel radial spherical plain bearings with an outside diameter  $D \geq 150$  mm as standard with the multi-groove feature in the outer ring (→ page 17). The extra large grease reservoir in the bearing, made possible by the multi-groove system, extends relubrication intervals and bearing service life, especially in applications where there are constant direction loads (→ page 40).

These advantages are considered in the calculation of the basic rating life by the coloured regions in diagrams 13 and 14 for the factors for the angle of oscillation  $b_5$  and  $f_{\beta}$ . The values of these two factors in the upper limit of the coloured area may be used for bearings with the multi-groove system.

Diagram 15

Relubrication factor  $f_H$  for steel/steel and steel/bronze sliding contact surface combinations

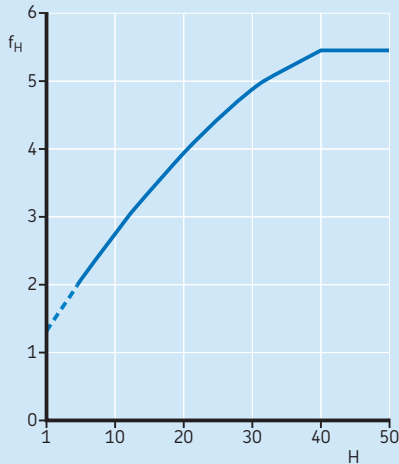

If  $H < 5$ , the values indicated by the broken line can be used.

## Selection of bearing size

### Maintenance-free steel/PTFE sintered bronze sliding contact surface combination

The basic rating life can be calculated using

$$G_h = b_1 b_2 \frac{1\,400}{p^{1.3} v}$$

or

$$G = 60 f G_h$$

where

$G_h$  = basic rating life, operating hours

$G$  = basic rating life, number of oscillations

$b_1$  = load condition factor (→ **table 6**)

$b_2$  = temperature factor (→ **diagram 16**)

$p$  = specific bearing load [N/mm<sup>2</sup>]

$v$  = mean sliding velocity [m/s]

$f$  = frequency of oscillation [min<sup>-1</sup>]

**NOTE:** Basic rating life calculations consider the influence of the load and sliding velocity. Under very light loads and/or low sliding velocities, the result shows relatively long life. The longer the service life the more important is the influence of contaminants such as dirt, moisture and corrosion. Depending on the operating conditions, accurate life calculations may not be possible.

Table 6

#### Load condition factor $b_1$ for the steel/PTFE sintered bronze sliding contact surface combination

| Type of load  | Factor $b_1$ | Permissible specific bearing load <sup>1)</sup> |
|---|--------------|---|
| –   | –            | N/mm <sup>2</sup>                               |
| <b>Constant load<sup>2)</sup></b><br>Single direction   | 1            | up to 100                                       |
| <b>Variable load</b><br>Alternating direction<br>or pulsating magnitude<br>at a frequency<br>up to 0,5 Hz | 0,4          | up to 60  |
| over 0,5 up to 5 Hz   | 0,2          | up to 40  |

<sup>1)</sup> Inertia forces should also be taken into consideration.

<sup>2)</sup> For constant load, oscillating frequencies above 300 min<sup>-1</sup> and very short sliding distances,  $b_1 = 1$  cannot be used because of possible material fatigue. For additional information, contact the SKF application engineering service.



Temperature factor  $b_2$  for the steel/PTFE sintered bronze sliding contact surface combination

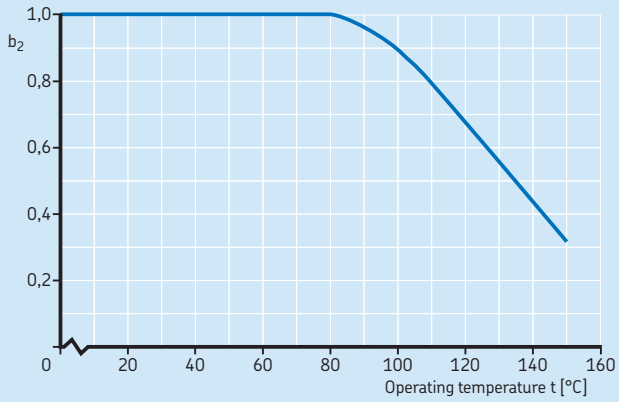

## Selection of bearing size

### Maintenance-free steel/PTFE fabric sliding contact surface combination

The basic rating life can be calculated using

$$G_h = b_1 b_2 b_4 \frac{K_p}{p^n v}$$

or

$$G = 60 f G_h$$

where

$G_h$  = basic rating life, operating hours

$G$  = basic rating life, number of oscillations

$b_1$  = load condition factor (→ **table 7**)

$b_2$  = temperature factor (→ **diagram 17**)

$b_4$  = velocity factor (→ **diagram 18** on **page 58**)

$K_p$  = constant for the specific bearing load  
(→ **table 8**)

$p$  = specific bearing load [N/mm<sup>2</sup>]

$n$  = exponent for the specific bearing load  
(→ **table 8**)

$v$  = mean sliding velocity [m/s]

$f$  = frequency of oscillation [min<sup>-1</sup>]

**NOTE:** Basic rating life calculations consider the influence of the load and sliding velocity. Under very light loads and/or low sliding velocities, the result shows relatively long life. The longer the service life the more important is the influence of contaminants such as dirt, moisture and corrosion. Depending on the operating conditions, accurate life calculations may not be possible.

Diagram 17

Temperature factor  $b_2$  for steel/PTFE fabric sliding contact surface combination

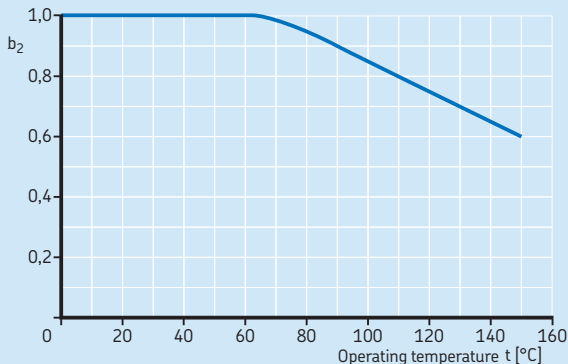

Table 7

**Load condition factor  $b_1$  for steel/PTFE fabric sliding contact surface combination**

| Type of load   | Factor $b_1^{1)}$ | Specific bearing load |
|--|-------------------|-----------------------|
| –  | –                 | N/mm <sup>2</sup>     |
| <b>Constant</b>  |                   |                       |
| Single direction   | 1                 | up to 300             |
| <b>Variable load</b>   |                   |                       |
| Alternating direction or pulsating magnitude at a frequency up to 0,5 Hz | 0,55<br>0,4       | up to 50<br>50 to 100 |
| over 0,5 to 1 Hz   | 0,35<br>0,15      | up to 50<br>50 to 100 |
| over 1 to 5 Hz   | 0,1               | up to 50              |

<sup>1)</sup>The factor  $b_1$  covers several parameters that affect the bearing life. Depending on the operating conditions, higher  $b_1$  values can be applied. Contact the SKF application engineering service.

Table 8

**Constant  $K_p$  and exponent  $n$  for steel/PTFE fabric sliding contact surface combination**

| Specific bearing load <sup>1)</sup><br>over incl. | Constant $K_p$ | Exponent $n$ |
|---|----------------|--------------|
| N/mm <sup>2</sup>                                 | –              | –            |
| –   | 770            | 0,2          |
| 25  | 4 000          | 0,7          |
| 90  | 40 000         | 1,2          |

<sup>1)</sup>For inch bearings, specific bearing load may not exceed 150 N/mm<sup>2</sup> (→ table 4 on page 45).

Velocity factor  $b_4$  for steel/PTFE fabric sliding contact surface combination

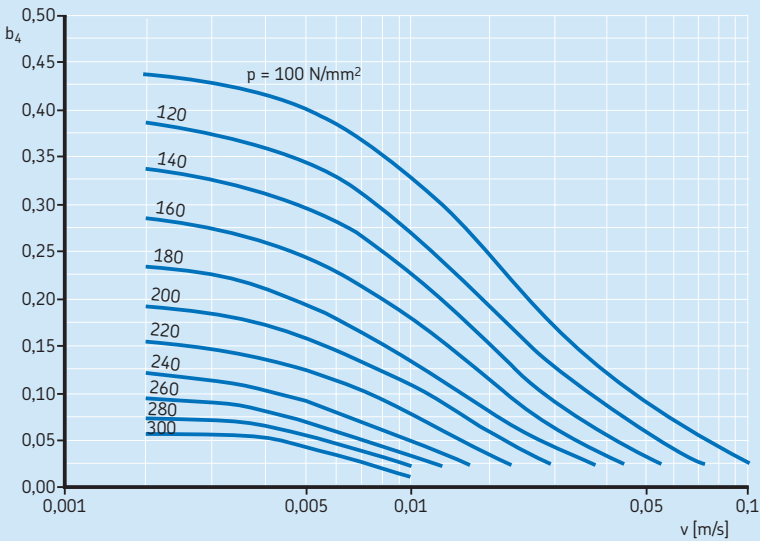
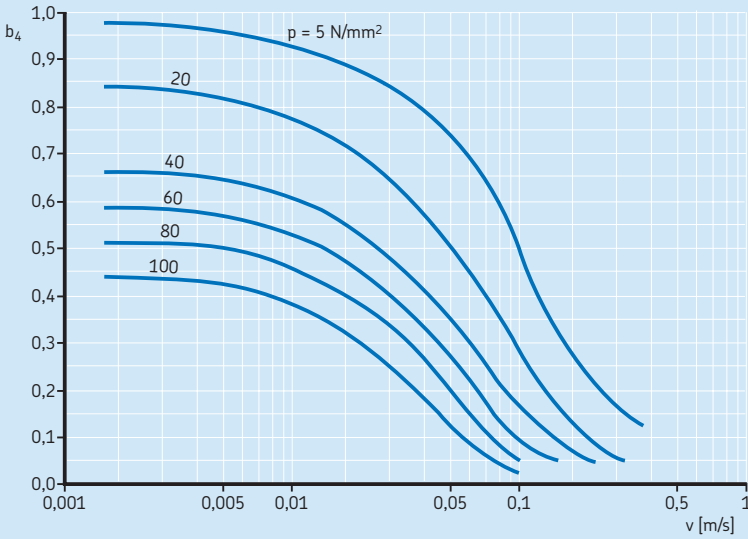

## Maintenance-free steel/PTFE FRP sliding contact surface combination

The basic rating life can be calculated using

$$G_h = b_1 b_2 b_3 \frac{K_M}{p v}$$

or

$$G = 60 f G_h$$

where

- $G_h$  = basic rating life, operating hours
- $G$  = basic rating life, number of oscillations
- $b_1$  = load condition factor (→ **table 9**)
- $b_2$  = temperature factor (→ **diagram 19**)
- $b_3$  = sliding factor (→ **table 10** on **page 60**)
- $K_M$  = material constant (→ **table 10** on **page 60**)
- $p$  = specific bearing load [ $\text{N}/\text{mm}^2$ ]
- $v$  = mean sliding velocity [ $\text{m}/\text{s}$ ]
- $f$  = frequency of oscillation [ $\text{min}^{-1}$ ]

### NOTE:

1. The basic rating life calculated from the above equation can be doubled if the bearings are relubricated occasionally (refer to the sections *Lubrication*, starting on **page 84** and *Relubrication* on **page 90**)
2. Rating life calculations consider the influence of the load and sliding velocity. Under very light loads, and/or low sliding velocities, the result shows relatively long life. The longer the service life the more important is the influence of contaminants such as dirt, moisture and corrosion. Depending on the operating conditions, accurate life calculations may not be possible.

Table 9

### Load condition factor $b_1$ for steel/PTFE FRP sliding contact surface combination

| Type of load | Factor $b_1$ | Permissible specific bearing load <sup>1)</sup> |
|--------------|--------------|---|
| –            | –            | $\text{N}/\text{mm}^2$                          |

#### Constant load<sup>2)</sup>

|                  |   |          |
|------------------|---|----------|
| Single direction |   |          |
| GAC .. F         | 1 | up to 50 |
| GX .. F          | 1 | up to 50 |
| GEP .. FS        | 1 | up to 80 |
| GEC .. FBAS      | 1 | up to 80 |

#### Variable load

|   |      |          |
|---|------|----------|
| Alternating direction or pulsating magnitude at a frequency |      |          |
| up to 0,5 Hz  | 0,25 | up to 40 |
| over 0,5 up to 5 Hz   | 0,1  | up to 25 |

<sup>1)</sup> Inertia forces should also be taken into consideration.

<sup>2)</sup> For constant load, oscillating frequencies above  $300 \text{ min}^{-1}$  and very short sliding distances,  $b_1 = 1$  cannot be used because of possible material fatigue. For additional information, contact the SKF application engineering service.

Diagram 19

### Temperature factor $b_2$ for steel/PTFE FRP sliding contact surface combination

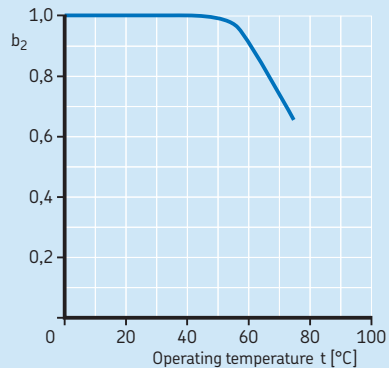

Table 10

Sliding factor  $b_3$  and constant  $K_M$  for steel/PTFE FRP sliding contact surface combination

| Bearing type<br>Series                       | Nominal<br>bore diameter<br>d |       | Sliding factor<br>$b_3$ | Constant<br>$K_M$ |
|--|-------------------------------|-------|-------------------------|-------------------|
|  | over                          | incl. |                         |                   |
| –  | mm                            |       | –                       | –                 |
| <b>Radial bearings</b>                       |                               |       |                         |                   |
| GEP .. FS                                    | –                             | 180   | 1                       | 1 055             |
|  | 180                           | 440   | 1,15                    | 1 055             |
|  | 440                           | –     | 1,35                    | 1 055             |
| GEC .. FBAS                                  | –                             | 440   | 1                       | 1 055             |
|  | 440                           | –     | 1,15                    | 1 055             |
| <b>Angular contact bearings<sup>1)</sup></b> |                               |       |                         |                   |
| GAC .. F                                     | –                             | 60    | 1                       | 480               |
|  | 60                            | –     | 1,5                     | 480               |
| <b>Thrust bearings</b>                       |                               |       |                         |                   |
| GX .. F                                      | –                             | 60    | 1                       | 670               |
|  | 60                            | –     | 1,5                     | 670               |
| <b>Rod ends</b>                              |                               |       | 1                       | 530               |

<sup>1)</sup> For preloaded bearings that cannot be re-adjusted, always use  $b_3 = 1$ .

## Variable load and sliding velocity

If the load and/or sliding velocity change during operation, calculate individual rating lives for the periods of constant load and sliding velocity. If the load and sliding velocity occur as shown in **diagram 20a**, the individual basic rating life can be calculated using the constant values of  $p$  and  $v$ . If the load and sliding velocity are not constant as shown in **diagram 20b**, first calculate the basic rating life for the individual time periods, using mean values for the load and sliding velocity for the individual time periods. Then calculate the total basic rating life using

$$G_h = \frac{1}{\frac{t_I}{T G_{hI}} + \frac{t_{II}}{T G_{hII}} + \frac{t_{III}}{T G_{hIII}} + \dots}$$

where

$G_h$  = total basic rating life, operating hours  
 $t_I, t_{II} \dots$  = time during which  $p_1$  and  $v_1, p_2$  and  $v_2$  etc. pertain [h]

$T$  = total duration of one cycle  
 (=  $t_I + t_{II} + t_{III} + \dots$ ) [h]

$G_{hI} \dots$  = individual values of basic rating life for conditions  $p_1$  and  $v_1, p_2$  and  $v_2$  etc., operating hours

Diagram 20

### Alternating load and variable sliding velocity

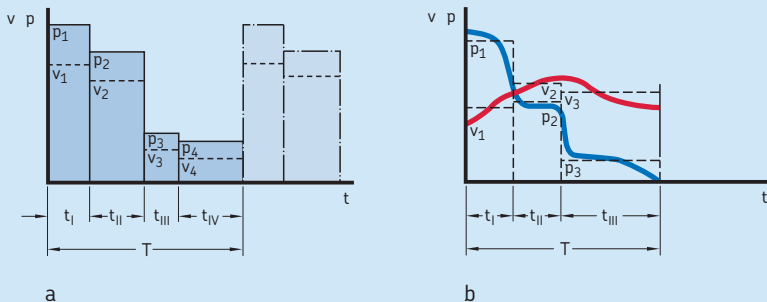

## Calculation examples

The following calculation examples illustrate the methods used to determine the requisite bearing size or the basic rating life for spherical plain bearings and rod ends.

### 1. Torque support of a concrete transporter

#### Given data

Purely radial load that alternates direction:

$$F_r = 12 \text{ kN}$$

Half angle of oscillation:  $\beta = 15^\circ$

(→ fig. 3 on page 39)

Frequency of oscillation:  $f = 10 \text{ min}^{-1}$

Maximum operating temperature:  $+80 \text{ }^\circ\text{C}$

#### Requirements

The bearing must have a basic rating life of 7 000 h.

#### Calculations and selection

Because a bearing in this application must accommodate an alternating load, a steel/steel radial spherical plain bearing is the appropriate choice. Relubrication is planned after every 40 hours of operation.

If, for the first check, a guideline value of 2 is used for the load ratio  $C/P$  (→ table 3 on page 45), the required basic dynamic load rating  $C$  for the bearing is

$$C = 2 P = 24 \text{ kN}$$

Bearing GE 20 ES, with a  $C = 30 \text{ kN}$  and a sphere diameter  $d_k = 29 \text{ mm}$ , is chosen from the product table on page 104.

To check the suitability of the bearing using the  $p_v$  diagram (→ diagram 5 on page 46), calculate the specific bearing load using  $K = 100$  from table 4 on page 45.

$$p = K \frac{P}{C} = 100 \times \frac{12}{30} = 40 \text{ N/mm}^2$$

and the sliding velocity  $v$  using  $d_m = d_k = 29 \text{ mm}$ ,  $\beta = 15^\circ$  and  $f = 10 \text{ min}^{-1}$

$$v = 5,82 \times 10^{-7} d_m \beta f$$

$$= 5,82 \times 10^{-7} \times 29 \times 15 \times 10 = 0,0025 \text{ m/s}$$

The values for  $p$  and  $v$  lie within the permissible operating range I of the  $p_v$  diagram (→ diagram 5 on page 46), for steel/steel radial spherical plain bearings. To calculate the basic rating life for initial lubrication, the values that apply are

$b_1 = 2$  (alternating direction load)

$b_2 = 1$  (operating temperature  $< 120 \text{ }^\circ\text{C}$   
from table 5 on page 52)

$b_3 = 1,5$  (from diagram 11 on page 51,  
for  $d_k = 29 \text{ mm}$ )

$b_4 = 1,1$  (from diagram 12 on page 52,  
for  $v = 0,0025 \text{ m/s}$ )

$b_5 = 3,7$  (from diagram 13 on page 52,  
for  $\beta = 15^\circ$ )

$p = 40 \text{ N/mm}^2$

$v = 0,0025 \text{ m/s}$

Therefore

$$G_h = b_1 b_2 b_3 b_4 b_5 \frac{330}{p^{2,5} v}$$

$$= 2 \times 1 \times 1,5 \times 1,1 \times 3,7 \times \frac{330}{40^{2,5} \times 0,0025}$$

$$\approx 160 \text{ operating hours}$$

The basic rating life of the bearing that is relubricated regularly can now be calculated using

$f_\beta = 5,2$  (from diagram 14 on page 53)

$f_H = 1,8$  (from diagram 15 on page 53, for a  
relubrication frequency  $H = G_h/N = 160/40$   
 $= 4$  with the relubrication interval of 40 h)

$$G_{hN} = G_h f_\beta f_H = 160 \times 5,2 \times 1,8$$

$$\approx 1\,500 \text{ operating hours}$$



Because this life is shorter than the required rating life of 7 000 h, a larger bearing is chosen and calculations are repeated.

Bearing GE 25 ES, with  $C = 48$  kN and  $d_k = 35,5$  mm, is chosen. The values for the specific bearing load lie within the permissible operating range I of the pv diagram (→ **diagram 5** on **page 46**)

$$p = 100 \times \frac{12}{48} = 25 \text{ N/mm}^2$$

and the sliding velocity is

$$v = 5,82 \times 10^{-7} \times 35,5 \times 15 \times 10 = 0,0031 \text{ m/s}$$

As before

$$b_1 = 2, b_2 = 1, b_5 = 3,7$$

and now

$$b_3 = 1,6 \text{ (from **diagram 11** on **page 51**,  
for } d_k = 35,5 \text{ mm)}$$

$$b_4 = 1,2 \text{ (from **diagram 12** on **page 52**,  
for } v = 0,0031 \text{ m/s)}$$

Therefore, the basic rating life for initial lubrication is

$$G_h = 2 \times 1 \times 1,6 \times 1,2 \times 3,7 \times \frac{330}{25^{2,5} \times 0,0031}$$

$$\approx 480 \text{ operating hours}$$

With  $f_B = 5,2$  (from **diagram 14** on **page 53**) and  $f_H = 3$  (from **diagram 15** on **page 53** for  $H = 480/40 = 12$ ) the basic rating life for regular relubrication ( $N = 40$  h) becomes

$$G_{hN} = 480 \times 5,2 \times 3 = 7\,490 \text{ operating hours}$$

This larger bearing satisfies the rating life requirement.

**NOTE:** The *SKF Interactive Engineering Catalogue* incorporates programs to perform these and many other calculations quickly and accurately. These programs can be run any number of times to find the best possible solution.

The *SKF Interactive Engineering Catalogue* is available online at [www.skf.com](http://www.skf.com).

## Selection of bearing size

### 2. Attachment of a shock absorber of an off-highway vehicle

#### Given data:

Radial load:  $F_r = 7 \text{ kN}$

Axial load:  $F_a = 0,7 \text{ kN}$

Half angle of oscillation:  $\beta = 8^\circ$  (→ **fig. 3** on **page 39**)

Frequency of oscillation:  $f = 15 \text{ min}^{-1}$

Load frequency: 2–5 Hz

Maximum operating temperature:  $+75^\circ\text{C}$

#### Requirements:

This bearing must have a basic rating life corresponding to a driven distance of 100 000 km at an average speed of 65 km/h without maintenance.

#### Calculations and selection

For design reasons, a GE 20 C spherical plain bearing with a steel/PTFE sintered bronze sliding contact surface combination is proposed.

From the product **table** on **page 132**, the basic dynamic load rating  $C = 31,5 \text{ kN}$  and the sphere diameter  $d_k = 29 \text{ mm}$  are obtained.

First, the equivalent dynamic bearing load must be determined by

$$F_a/F_r = 0,7/7 = 0,1$$

From **diagram 2** on **page 42** factor  $y = 1,4$ . The equivalent dynamic bearing load is therefore

$$P = y F_r = 1,4 \times 7 = 9,8 \text{ kN}$$

To check the suitability of the bearing size using the **pv diagram 7** on **page 48**, calculate the values for the specific bearing load (using  $K = 100$  from **table 4** on **page 45**) using

$$p = K \frac{P}{C} = 100 \times \frac{9,8}{31,5} = 31 \text{ N/mm}^2$$

and the sliding velocity ( $d_m = d_k = 29 \text{ mm}$ ).

$$v = 5,82 \times 10^{-7} \text{ dm } \beta f$$

$$= 5,82 \times 10^{-7} \times 29 \times 8 \times 15 = 0,002 \text{ m/s}$$

The values for  $p$  and  $v$  lie within the permissible operating range I of the  $pv$  diagram where

$b_1 = 0,2$  (from **table 6** on **page 54**, for a load frequency over 0,5 Hz and  $25 < p < 40 \text{ N/mm}^2$ )

$b_2 = 1$  (from **diagram 16** on **page 55**, for temperatures  $< 80^\circ\text{C}$ )

The basic rating life for a GE 20 C bearing with the steel/PTFE sintered bronze sliding contact surface combination is

$$G_h = b_1 b_2 \frac{1\,400}{p^{1,3} v}$$
$$= 0,2 \times 1 \times \frac{1\,400}{31^{1,3} \times 0,002}$$

$$\approx 1\,600 \text{ operating hours}$$

This basic rating life corresponds to a distance (at an average speed of 65 km/h) of  $1\,600 \times 65 = 104\,000 \text{ km}$ . Therefore, the bearing satisfies the rating life requirement.

### 3. A 320-bar hydraulic cylinder on a fully automatic press for building industry waste

#### Given data

Radial load (constant direction)

| Operation case | Load $F_r$ | Time period $t$ |
|----------------|------------|-----------------|
| I              | 300 kN     | 10%             |
| II             | 180 kN     | 40%             |
| III            | 120 kN     | 50%             |

The number of press cycles  $n = 30$  per hour, and the movement between the end positions ( $90^\circ$ ) is made in 10 seconds. The operating temperature is less than  $+50^\circ\text{C}$ .

#### Requirements

A maintenance-free radial spherical plain bearing with a steel/PTFE fabric sliding contact surface combination is required for a rating life of 5 years with 70 h of operation per week.

#### Calculations and selection

Using a guideline value for the load ratio  $C/P = 2$  ( $\rightarrow$  **table 3 on page 45**), and with  $P = F_{rI}$  the required basic dynamic load rating

$$C = 2P = 2 \times 300 = 600 \text{ kN}$$

From the product **table on page 136**, a GE 60 TXE-2LS bearing with a basic dynamic load rating  $C = 695 \text{ kN}$  and a sphere diameter  $d_k = d_m = 80 \text{ mm}$  is chosen.

First, it is necessary to check that the operation cases I to III fall within the permissible range of the **pv diagram 8 on page 49**.

The sliding velocity is the same for all three cases. The angle of oscillation is specified as  $2\beta$ , the time  $t$  as the time taken to pass through  $2\beta$  in seconds. Complete cycle duration is  $4\beta$  ( $\rightarrow$  **fig 3 on page 39**).

$$v = 8,73 \times 10^{-6} d_m \frac{2\beta}{t}$$

$$= 8,73 \times 10^{-6} \times 80 \times \frac{90}{10} = 0,0063 \text{ m/s}$$

The specific bearing load,  $p = K(P/C)$ , using  $K = 300$  from **table 4 on page 45**, is

for case I

$$p_I = K \frac{P}{C} = 300 \times \frac{300}{695} = 129,5 \text{ N/mm}^2$$

for case II

$$p_{II} = K \frac{P}{C} = 300 \times \frac{180}{695} = 77,7 \text{ N/mm}^2$$

for case III

$$p_{III} = K \frac{P}{C} = 300 \times \frac{120}{695} = 51,8 \text{ N/mm}^2$$

The values for  $p_I$ ,  $p_{II}$ ,  $p_{III}$  and  $v$  are within the permissible range I of the **pv diagram 8 on page 49**.

To make the lifetime estimate for variable loads and/or sliding velocities, the calculation of each load case has to be made separately, with the equation for TX bearings first

$$G_n = b_1 b_2 b_4 \frac{K_p}{p^n v}$$

The parameters  $b_1$ ,  $b_2$ ,  $b_4$ ,  $K_p$  and  $n$  are defined on **page 56** and are as follows

$b_1 = 1$  (from **table 7 on page 57**, constant load)  
 $b_2 = 1$  (from **diagram 17 on page 56**, operating temperature  $< +50^\circ\text{C}$ )

$b_4 =$  (from **diagram 18 on page 58**)

$$b_{4I} = 0,31$$

$$b_{4II} = 0,48$$

$$b_{4III} = 0,57$$

$K_p =$  (from **table 8 on page 57**)

$$K_{pI} = 40\,000$$

$$K_{pII} = 4\,000$$

$$K_{pIII} = 4\,000$$

$n =$  (from **table 8 on page 57**)

$$n_1 = 1,2$$

$$n_2 = 0,7$$

$$n_3 = 0,7$$

## Selection of bearing size

for case I

$$G_{hI} = 1 \times 1 \times 0,31 \times \frac{40\,000}{129,5^{1,2} \times 0,0063}$$

$$= 5\,745 \text{ operating hours}$$

for case II

$$G_{hII} = 1 \times 1 \times 0,48 \times \frac{4\,000}{77,7^{0,7} \times 0,0063}$$

$$= 14\,477 \text{ operating hours}$$

for case III

$$G_{hIII} = 1 \times 1 \times 0,57 \times \frac{4\,000}{51,8^{0,7} \times 0,0063}$$

$$= 22\,833 \text{ operating hours}$$

Using the calculated basic rating lives of the three operation cases, the total basic rating life for continuous operation is (→ page 61)

$$G_h = \frac{1}{\frac{t_I}{T G_{hI}} + \frac{t_{II}}{T G_{hII}} + \frac{t_{III}}{T G_{hIII}}}$$

For  $t_I$ ,  $t_{II}$  etc., the percentages given in the operating data are inserted (with  $T = t_I + t_{II} + t_{III} = 100\%$ .)

$$G_h = \frac{1}{\frac{10}{100 \times 5\,745} + \frac{40}{100 \times 14\,477} + \frac{50}{100 \times 22\,833}}$$

$$\approx 14\,940 \text{ operating hours}$$

The required life of five years should be met assuming the machine is operated 70 h/week, 30 cycles/hour and 50 weeks per year, to 525 000 cycles or 2 916 operating hours. (Note that time for a complete cycle is 20 s.)

$$G_{N, \text{Req}} = 5 \times 70 \times 30 \times 50 = 525\,000 \text{ cycles}$$

$$G_{h, \text{Req}} = (525\,000 \times 20) / 3600 = 2\,916 \text{ h.}$$

#### 4. Linkages of a conveyor installation

##### Given data

Radial load of alternating direction:  $F_r = 5,5 \text{ kN}$   
 Half angle of oscillation:  $\beta = 15^\circ$  (→ **fig. 3** on **page 39**)

Frequency of oscillation:  $f = 25 \text{ min}^{-1}$

Operating temperature:  $+70 \text{ }^\circ\text{C}$

##### Requirements

A rod end is needed that provides a basic rating life of 9 000 hours under alternating load conditions.

##### Calculations and selection

Because the load is alternating, a steel/steel rod end is appropriate. Relubrication is planned every 40 hours of operation. Using the guideline value for the load ratio  $C/P = 2$  from **table 3** on **page 45**, and as  $P = F_r$ , the requisite basic dynamic load rating is

$$C = 2P = 2 \times 5,5 = 11 \text{ kN}$$

The SI 15 ES rod end with a basic dynamic load rating  $C = 17 \text{ kN}$  is selected (→ **page 172**). The basic static load rating is  $C_0 = 37,5 \text{ kN}$  and the sphere diameter  $d_k = 22 \text{ mm}$ .

To check the suitability of rod end size using the  $p_v$  **diagram 5** on **page 46**, calculate the values for the specific bearing load (using  $K = 100$  from **table 4** on **page 45**)

$$p = K \frac{P}{C} = 100 \times \frac{300}{695} = 32,4 \text{ N/mm}^2$$

and the mean sliding velocity ( $d_m = d_k = 22 \text{ mm}$ )

$$v = 5,82 \times 10^{-7} d_k \beta f$$

$$= 5,82 \times 10^{-7} \times 22 \times 15 \times 25 = 0,0048 \text{ m/s}$$

The values for  $p$  and  $v$  lie within the permissible range I of the  $p_v$  **diagram 5** on **page 46**.

Checking the permissible load on the rod end housing

$$C_0 = 37,5 \text{ kN}$$

$$b_2 = 1 \text{ (from table 5 on page 52, for temperatures } < 120 \text{ }^\circ\text{C)}$$

$$b_6 = 0,35 \text{ (from table 2 on page 44, for rod ends with a lubrication hole)}$$

$$P_{\text{perm}} = C_0 b_2 b_6$$

$$= 37,5 \times 1 \times 0,35$$

$$= 13,125 \text{ kN} > P$$

The following values of the factors are used to determine the basic rating life for initial lubrication only

$$b_1 = 2 \text{ (alternating load)}$$

$$b_2 = 1 \text{ (for operating temperatures } < 120 \text{ }^\circ\text{C, from table 5 on page 52)}$$

$$b_3 = 1,3 \text{ (from diagram 11 on page 51, for } d_k = 22 \text{ mm)}$$

$$b_4 = 1,6 \text{ (from diagram 12 on page 52, for } v = 0,0048 \text{ m/s)}$$

$$b_5 = 3,7 \text{ (from diagram 13 on page 52, for } \beta = 15^\circ)$$

$$p = 32 \text{ N/mm}^2$$

$$v = 0,0048 \text{ m/s}$$

Therefore

$$G_h = b_1 b_2 b_3 b_4 b_5 \frac{330}{32,4^{2,5} \times 0,0048}$$

$$= 2 \times 1 \times 1,3 \times 1,6 \times 3,7 \times \frac{330}{32,4^{2,5} \times 0,0048}$$

$$\approx 177 \text{ operating hours}$$

The basic rating life for regular relubrication ( $N = 40 \text{ h}$ ) with

$$f_\beta = 5,2 \text{ (from diagram 14 on page 53) and}$$

$$f_H = 2 \text{ (from diagram 15 on page 53, for } H = G_h/N = 177/40 = 4,4)$$

$$G_{hN} = G_h f_\beta f_H = 177 \times 5,2 \times 2$$

$$\approx 1840 \text{ operating hours}$$

## Selection of bearing size

The required basic rating life of 9 000 h is not achieved; therefore a larger rod end has to be selected. A SI 20 ES rod end, with  $C = 30$  kN,  $C_0 = 57$  kN and  $d_k = 29$  mm is selected and the calculation repeated.

The values for the specific bearing load

$$p = K \frac{P}{C} = 100 \times \frac{5,5}{30} = 18,3 \text{ N/mm}^2$$

and the mean sliding velocity ( $d_m = d_k = 29$  mm)

$$v = 5,82 \times 10^{-7} \times 29 \times 15 \times 25 = 0,0063 \text{ m/s}$$

both lie within the permissible range I. It is not necessary to check the permissible rod end housing load since the basic static load rating of the larger rod end is higher. Also, as before

$$b_1 = 2; b_2 = 1 \text{ and } b_5 = 3,7$$

while

$$b_3 = 1,4 \text{ (from **diagram 11** on **page 51**,  
for } d_k = 29 \text{ mm)}$$

$$b_4 = 1,8 \text{ (from **diagram 12** on **page 52**,  
for } v = 0,0063 \text{ m/s)}$$

so that

$$G_h = 2 \times 1 \times 1,4 \times 1,8 \times 3,7 \times \frac{330}{18,3^{2,5} \times 0,0063}$$

$$\approx 681 \text{ operating hours}$$

With  $f_B = 5,2$  (from **diagram 14** on **page 53**) and  $f_H = 3,7$  (from **diagram 15** on **page 53**, for  $H = 681/40 \approx 17$ ) the basic rating life for regular relubrication ( $N = 40$  h) becomes

$$G_{hN} = 681 \times 5,2 \times 3,7$$

$$\approx 13\,100 \text{ operating hours}$$

Therefore, the larger rod end meets the rating life requirements.

# Friction

The friction in a spherical plain bearing or rod end depends primarily on the sliding contact surface combination, the load and the sliding velocity. Because there are so many influencing factors that are not mutually independent, it is not possible to quote exact values for the coefficient of friction. Under laboratory conditions, however, it is possible to record the coefficient of friction for different sliding contact surface combinations. The friction during the running-in phase is higher than the value recorded during the subsequent test period.

Guideline values for the coefficient of friction  $\mu$  are listed in **table 1**. They have been determined in laboratory trials.

The coefficient of friction for maintenance-free steel/PTFE fabric and steel/PTFE sintered bronze sliding contact surface combinations decrease with increasing specific load. At a constant specific load, friction is reduced to the given minimum value as soon as the transfer of PTFE from the sliding layer to the opposing steel surface is complete. The frictional moment for a spherical plain bearing or rod end can be calculated using

$$M = 0,5 \mu P d_m$$

where

$M$  = frictional moment [Nm]

$\mu$  = coefficient of friction ( $\rightarrow$  **table 1**)

$P$  = equivalent dynamic bearing load [kN]

$d_m$  = inner ring mean diameter [mm]

$d_m = d_k$  for radial spherical plain bearings and rod ends

$d_m = 0,9 d_k$  for angular contact spherical plain bearings

$d_m = 0,7 d_k$  for thrust spherical plain bearings

$d_k$  = inner ring sphere diameter [mm]

**Table 1**

**Coefficient of friction for different sliding contact surface combinations (guideline values)**

| Sliding contact surface combination | Coefficient of friction $\mu$ |      |
|-------------------------------------|-------------------------------|------|
|                                     | min                           | max  |
| Steel/steel                         | 0,08                          | 0,20 |
| Steel/bronze                        | 0,10                          | 0,25 |
| Steel/PTFE sintered bronze          | 0,05                          | 0,25 |
| Steel/PTFE fabric                   | 0,02                          | 0,15 |
| Steel/PTFE FRP                      | 0,05                          | 0,20 |

After the bearing has been in operation for an extended period of time, negative influences (contamination, inadequate lubrication) may cause the bearing to approach or exceed the maximum values for the coefficient of friction listed in the table. Bearings are susceptible to this phenomenon even under light loads and especially under harsh operating conditions. In applications where friction is particularly important, SKF recommends determining the power ratings by using the maximum values for the coefficient of friction that are listed in **table 1**. For bearings operating under conditions of mixed or dry friction, there may be slight differences between adhesive and sliding friction. Experience has shown that it is not possible to eliminate stick-slip entirely and that it most frequently occurs when support elements lack adequate stiffness. In most applications, however, the effects are negligible.

# Design of bearing arrangements

## Radial location of bearings

The inner and outer rings of spherical plain bearings must be radially secured (located) to the shaft and in the housing so that sliding movements occur in the bearing and do not result in ring creep. Ring creep occurs when a ring turns on its seat in the circumferential direction under load. To locate a bearing in the radial direction usually requires an interference fit. However, an interference fit cannot always be applied, e.g. if easy mounting and dismounting are required, or if the bearing must be able to be displaced axially without restraint.

The appropriate fit is always determined by the operating conditions.

### 1. Type and magnitude of the load

The degree of interference must suit the type and magnitude of the load, i.e. the heavier the load and the stronger the shock loads, the tighter the interference required (→ **fig. 1**).

- Under heavy loads, spherical plain bearings deform elastically, which may affect the interference fit and lead to ring creep.
- The strength of the associated components must be adequate to accommodate the loads and fully support the bearing.
- If the associated components deform, there is a risk that through-hardened bearing rings crack.
- Steel/steel radial spherical plain bearings require a tighter fit than comparable maintenance-free bearings, which have a lower coefficient of friction.

### 2. Bearing internal clearance

An interference fit on the shaft and in the housing causes the inner ring to expand elastically, and the outer ring to be compressed elastically.

This reduces the initial internal clearance in the bearing, prior to operation. The operating clearance (→ **fig. 2**) furthermore takes the load and operating temperature into consideration.

The initial radial internal clearance of bearings differs, depending on the type and size of the bearing. The clearance has been selected so that if the recommended tolerances for the shaft and housing seats are applied, an appropriate operating clearance (or preload) remains in the bearing under normal operating conditions.

If a tight interference fit is used for both bearing rings, or if the operating temperatures are unusual, it may be necessary to use a larger initial internal clearance than “Normal” for steel/steel bearings.

### 3. Temperature conditions

In operation, the bearing rings normally have a higher temperature than their seats. This means that

- the inner ring fit gets looser (→ **fig. 3**)
- the outer ring fit becomes tighter and may restrict any required axial displacement in the housing.

If there is a considerable temperature difference between the inner ring and outer ring, there is a change in the operating clearance. This condition must be considered when selecting the fit or the bearing could seize, making it difficult or impossible for the shaft to turn.



Fig. 1

For heavier loads a tighter interference fit is needed

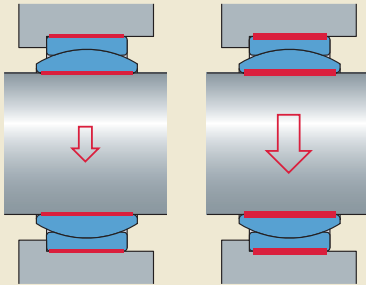

4. Design of associated components

The bearing seats on the shaft and in the housing must not lead to uneven distortion (out-of-round) of the bearing rings (→ fig. 4). Therefore:

- Split housings are not suitable for interference fits.
- Thin-walled housings, light alloy housings and hollow shafts require a tighter fit than thick-walled steel or cast iron housings and solid shafts – and must have sufficient strength.
- Heavy loads and interference fits require thick-walled one-piece steel or cast iron housings and solid steel shafts.

Fig. 2

Reduction of the clearance in the bearing

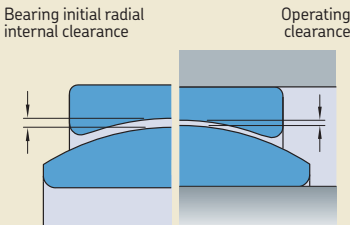

Fig. 3

Change to the fit with temperature

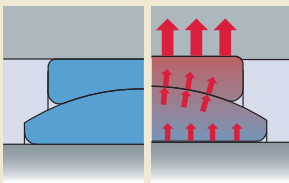
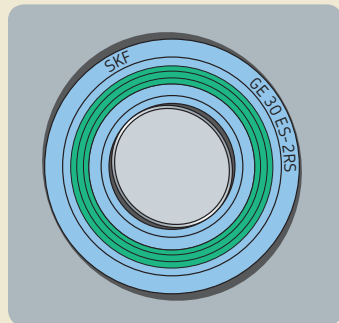

Fig. 4

Out-of-round bearing seat



## Design of bearing arrangements

### 5. Axial displacement of non-locating bearings

A non-locating bearing provides radial support only and must always be able to be displaced axially (→ **fig. 5**). This is normally achieved by selecting a loose fit for one of the bearing rings, generally the inner ring of a spherical plain bearing. Reasons include the following:

- The shaft seat can be easily and economically hardened and ground to facilitate axial displacement. The hardness of the shaft should be at least 50 HRC.
- The outer rings of most spherical plain bearings are axially fractured at one or two positions, or are radially split. This can make axial displacement difficult, if not impossible.
- The housing bore should be protected against wear.

#### Surface finish of seats

The recommended surface roughness for bearing seats is in accordance with ISO 4288:1997.

- for shaft seats  $R_z \leq 10 \mu\text{m}$
- for housing bore seats  $R_z \leq 16 \mu\text{m}$

#### Recommended fits

Only a limited number of ISO tolerance classes are appropriate for spherical plain bearings.

**Fig. 6** shows schematically the relative positions of these in relation to the bore and outside diameter of the bearings. The recommended tolerance classes for

- the shaft seat are provided in **table 1**
- the housing bore are provided in **table 2**

These recommendations are based on the considerations described above and have been confirmed in a wide variety of bearing applications. The ISO tolerance limits are listed in

- **table 3** on **page 74** for shafts
- **table 4** on **page 74** for housing bores

To facilitate the calculation of the minimum and maximum values of the theoretical interference or clearance, the standardized bearing bore diameter deviations ( $\Delta_{d_{mp}}$ ) and the bearing outside diameter deviations ( $\Delta_{D_{mp}}$ ) are listed in **tables 3** and **4**.

Fig. 5

#### Axial displacement

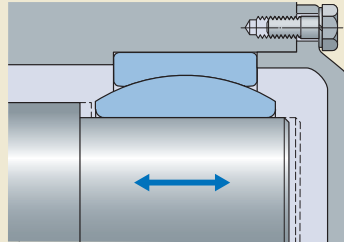

Fig. 6

#### ISO shaft and housing tolerance classes

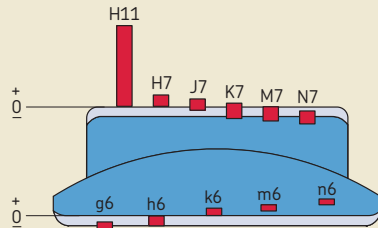

Table 1

## Shaft fits

| Operating conditions  | Tolerance classes                   |  |
|---|-------------------------------------|--|
|   | Sliding contact surface combination |  |
|   | steel/steel and steel/bronze        | steel/PTFE sintered bronze, steel/PTFE fabric and steel/PTFE FRP |
| <b>Radial spherical plain bearings</b><br>Loads of all kinds, interference fit          | m6 (n6) <sup>1)</sup>               | k6   |
| Loads of all kinds, clearance or transition fit   | h6 (hardened shaft)                 | h6 or g6 (hardened shaft)  |
| <b>Angular contact spherical plain bearings</b><br>Loads of all kinds, interference fit | m6 (n6)                             | m6   |
| <b>Thrust spherical plain bearings</b><br>Loads of all kinds, interference fit          | m6 (n6)                             | m6   |

The tolerance classes in brackets should be selected for very heavily loaded bearings. If selected, be sure that the residual operating clearance is sufficient for proper performance of the bearing or whether a bearing with larger clearance must be used.

<sup>1)</sup> These recommendations do not apply to bearings in the GEG series, which have a bore diameter tolerance class to H7 and are normally mounted on shaft seats machined to tolerance class m7. If, for mounting reasons, the shaft is machined to tolerance class f7, it should be hardened as movements of the shaft relative to the bearing bore take place and wear may result.

Table 2

## Housing fits

| Operating conditions  | Tolerance classes                   |  |
|---|-------------------------------------|--|
|   | Sliding contact surface combination |  |
|   | steel/steel                         | steel/PTFE sintered bronze, steel/PTFE fabric and steel/PTFE FRP |
| <b>Radial spherical plain bearings</b><br>Light loads, axial displacement required      | H7                                  | H7   |
| Heavy loads   | M7 (N7)                             | K7   |
| Light alloy housings  | N7                                  | M7   |
| <b>Angular contact spherical plain bearings</b><br>Loads of all kinds, interference fit | M7 (N7)                             | M7   |
| Loads of all kinds, can generally be displaced axially                                  | J7                                  | J7   |
| <b>Thrust spherical plain bearings</b><br>Purely axial loads                            | H11                                 | H11  |
| Combined loads  | J7                                  | J7   |

The tolerance classes in brackets should be selected for very heavily loaded bearings. If selected, be sure that the residual operating clearance of the radial bearing is sufficient for proper performance or whether a bearing with larger clearance must be used.

## Design of bearing arrangements

Table 3

### ISO tolerance classes for shafts

| Shaft<br>Nominal diameter |              | Bearing<br>Bore diameter<br>tolerance |      | Shaft diameter deviations<br>Tolerance classes |     |            |     |            |     |            |     |            |     |
|---------------------------|--------------|---------------------------------------|------|--|-----|------------|-----|------------|-----|------------|-----|------------|-----|
| d<br>over                 | incl.        | $\Delta_{dmp}$<br>low                 | high | g6<br>high                                     | low | h6<br>high | low | k6<br>high | low | m6<br>high | low | n6<br>high | low |
| mm                        |              | $\mu\text{m}$                         |      | $\mu\text{m}$                                  |     |            |     |            |     |            |     |            |     |
| <b>3</b>                  | <b>6</b>     | -8                                    | 0    | -4   | -12 | 0          | -8  | +9         | +1  | +12        | +4  | +16        | +8  |
| <b>6</b>                  | <b>10</b>    | -8                                    | 0    | -5   | -14 | 0          | -9  | +10        | +1  | +15        | +6  | +19        | +10 |
| <b>10</b>                 | <b>18</b>    | -8                                    | 0    | -6   | -17 | 0          | -11 | +12        | +1  | +18        | +7  | +23        | +12 |
| <b>18</b>                 | <b>30</b>    | -10                                   | 0    | -7   | -20 | 0          | -13 | +15        | +2  | +21        | +8  | +28        | +15 |
| <b>30</b>                 | <b>50</b>    | -12                                   | 0    | -9   | -25 | 0          | -16 | +18        | +2  | +25        | +9  | +33        | +17 |
| <b>50</b>                 | <b>80</b>    | -15                                   | 0    | -10  | -29 | 0          | -19 | +21        | +2  | +30        | +11 | +39        | +20 |
| <b>80</b>                 | <b>120</b>   | -20                                   | 0    | -12  | -34 | 0          | -22 | +25        | +3  | +35        | +13 | +45        | +23 |
| <b>120</b>                | <b>180</b>   | -25                                   | 0    | -14  | -39 | 0          | -25 | +28        | +3  | +40        | +15 | +52        | +27 |
| <b>180</b>                | <b>250</b>   | -30                                   | 0    | -15  | -44 | 0          | -29 | +33        | +4  | +46        | +17 | +60        | +31 |
| <b>250</b>                | <b>315</b>   | -35                                   | 0    | -17  | -49 | 0          | -32 | +36        | +4  | +52        | +20 | +66        | +34 |
| <b>315</b>                | <b>400</b>   | -40                                   | 0    | -18  | -54 | 0          | -36 | +40        | +4  | +57        | +21 | +73        | +37 |
| <b>400</b>                | <b>500</b>   | -45                                   | 0    | -20  | -60 | 0          | -40 | +45        | +5  | +63        | +23 | +80        | +40 |
| <b>500</b>                | <b>630</b>   | -50                                   | 0    | -22  | -66 | 0          | -44 | +44        | 0   | +70        | +26 | +88        | +44 |
| <b>630</b>                | <b>800</b>   | -75                                   | 0    | -24  | -74 | 0          | -50 | +50        | 0   | +80        | +30 | +100       | +50 |
| <b>800</b>                | <b>1 000</b> | -100                                  | 0    | -26  | -82 | 0          | -56 | +56        | 0   | +90        | +34 | +112       | +56 |
| <b>1 000</b>              | <b>1 250</b> | -125                                  | 0    | -28  | -94 | 0          | -66 | +66        | 0   | +106       | +40 | +132       | +66 |

Table 4

### ISO tolerance classes for housings

| Housing<br>Nominal bore<br>diameter |              | Bearing<br>Outside<br>diameter<br>tolerance |      | Housing bore diameter deviations<br>Tolerance classes |      |           |      |           |      |           |      |           |      |           |      |
|-------------------------------------|--------------|---|------|---|------|-----------|------|-----------|------|-----------|------|-----------|------|-----------|------|
| d<br>over                           | incl.        | $\Delta_{Dmp}$<br>high                      | low  | H11<br>low  | high | H7<br>low | high | J7<br>low | high | K7<br>low | high | M7<br>low | high | N7<br>low | high |
| mm                                  |              | $\mu\text{m}$                               |      | $\mu\text{m}$   |      |           |      |           |      |           |      |           |      |           |      |
| <b>10</b>                           | <b>18</b>    | 0   | -8   | 0   | +110 | 0         | +18  | -8        | +10  | -12       | +6   | -18       | 0    | -23       | -5   |
| <b>18</b>                           | <b>30</b>    | 0   | -9   | 0   | +130 | 0         | +21  | -9        | +12  | -15       | +6   | -21       | 0    | -28       | -7   |
| <b>30</b>                           | <b>50</b>    | 0   | -11  | 0   | +160 | 0         | +25  | -11       | +14  | -18       | +7   | -25       | 0    | -33       | -8   |
| <b>50</b>                           | <b>80</b>    | 0   | -13  | 0   | +190 | 0         | +30  | -12       | +18  | -21       | +9   | -30       | 0    | -39       | -9   |
| <b>80</b>                           | <b>120</b>   | 0   | -15  | 0   | +220 | 0         | +35  | -13       | +22  | -25       | +10  | -35       | 0    | -45       | -10  |
| <b>120</b>                          | <b>150</b>   | 0   | -18  | 0   | +250 | 0         | +40  | -14       | +26  | -28       | +12  | -40       | 0    | -52       | -12  |
| <b>150</b>                          | <b>180</b>   | 0   | -25  | 0   | +250 | 0         | +40  | -14       | +26  | -28       | +12  | -40       | 0    | -52       | -12  |
| <b>180</b>                          | <b>250</b>   | 0   | -30  | 0   | +290 | 0         | +46  | -16       | +30  | -33       | +13  | -46       | 0    | -60       | -14  |
| <b>250</b>                          | <b>315</b>   | 0   | -35  | 0   | +320 | 0         | +52  | -16       | +36  | -36       | +16  | -52       | 0    | -66       | -14  |
| <b>315</b>                          | <b>400</b>   | 0   | -40  | 0   | +360 | 0         | +57  | -18       | +39  | -40       | +17  | -57       | 0    | -73       | -16  |
| <b>400</b>                          | <b>500</b>   | 0   | -45  | 0   | +400 | 0         | +63  | -20       | +43  | -45       | +18  | -63       | 0    | -80       | -17  |
| <b>500</b>                          | <b>630</b>   | 0   | -50  | 0   | +440 | 0         | +70  | -         | -    | -70       | 0    | -96       | -26  | -114      | -44  |
| <b>630</b>                          | <b>800</b>   | 0   | -75  | 0   | +500 | 0         | +80  | -         | -    | -80       | 0    | -110      | -30  | -130      | -50  |
| <b>800</b>                          | <b>1 000</b> | 0   | -100 | 0   | +560 | 0         | +90  | -         | -    | -90       | 0    | -124      | -34  | -146      | -56  |
| <b>1 000</b>                        | <b>1 250</b> | 0   | -125 | 0   | +660 | 0         | +105 | -         | -    | -105      | 0    | -145      | -40  | -171      | -66  |
| <b>1 250</b>                        | <b>1 600</b> | 0   | -160 | 0   | +780 | 0         | +125 | -         | -    | -125      | 0    | -173      | -48  | -203      | -78  |
| <b>1 600</b>                        | <b>2 000</b> | 0   | -200 | 0   | +920 | 0         | +150 | -         | -    | -150      | 0    | -208      | -58  | -242      | -92  |

# Axial location of bearings

## Locating bearings

An interference fit alone is not sufficient to axially locate a bearing ring. It is usually necessary to use a suitable locking device to secure the ring in place.

Both rings of a locating bearing should be located axially on both sides. The bearing rings generally have an interference fit and are usually supported on one side by a shaft or housing shoulder. Inner rings are axially secured on the opposite end by

- a plate bolted to the shaft end (→ **fig. 7**)
- a spacer sleeve between the ring and a neighbouring machine component (→ **fig. 8**)
- a retaining ring (circlip)

Outer rings are generally retained by the cover of the housing bore (→ **figs. 7 and 8**).

## Non-locating bearings

For non-locating bearings, the outer ring (which normally has a tight fit) is axially located while the inner ring is free to move axially on the shaft (→ **fig. 5 on page 72**).

Note that for bearings in the GEP series (→ **fig. 9**), which have a radially split outer ring, expansion forces are produced under purely radial load; the axial components of these forces act on the housing cover. The axial load acting on the cover may be as much as 30% of the radial load. This must be taken into account when

Fig. 7

Using an end plate and cover to locate a bearing axially

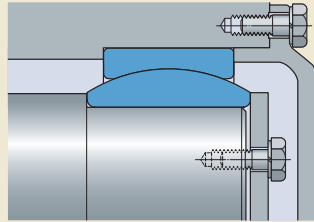

Fig. 8

Using a spacer sleeve and cover to locate a bearing axially

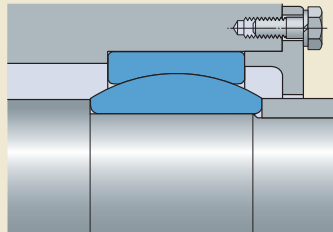
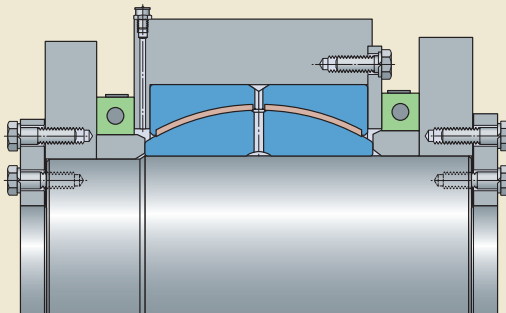

Fig. 9

Locating a radial spherical plain bearing having a radially split outer ring



## Design of bearing arrangements

dimensioning the housing cover and selecting the size and number of the attachment bolts.

If shaft and/or housing shoulders are undesirable because of manufacturing or assembly considerations, spacer sleeves or rings can be inserted between a bearing ring and an adjacent machine component (→ **figs. 10** and **11**).

Axially locating a non-separable bearing with locating rings (→ **figs. 10** and **11**) saves space, enables quick mounting and dismounting and simplifies the machining of the seats. If larger axial forces have to be accommodated, a support ring (→ **fig. 11**) should be placed between the bearing ring and the locating ring, so that the locating ring is not subjected to excessive bending moments.

To locate the bearing, retaining rings (also known as circlips) with a constant radial width in accordance with DIN 471:1981 or DIN 472:1981 can be used.

Fig. 10

Locating a bearing axially, using retaining rings in the housing and adjacent components on the shaft

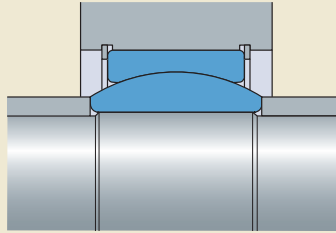

Fig. 11

Locating a bearing axially, using adjacent components in the housing and a support ring and a retaining ring on the shaft

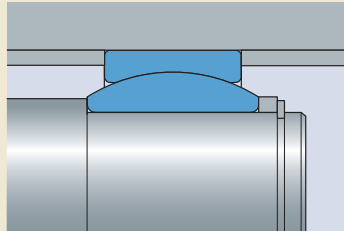

Fig. 12

Shaft and housing abutment dimensions

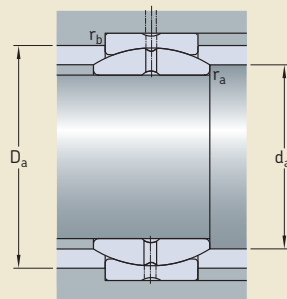
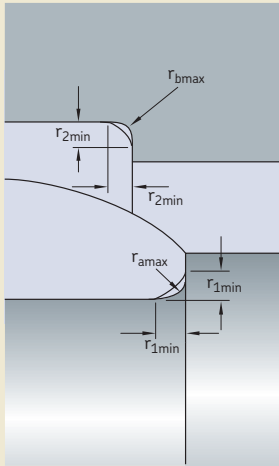

Fig. 13

Shaft and housing fillet dimensions, no undercut



## Abutment and fillet dimensions

The abutment and fillet dimensions should be such that:

- A sufficiently large support surface is available for the bearing ring.
- Moving parts of the bearing arrangement cannot contact stationary components.
- The fillet radius should be smaller than the chamfer of the bearing.

Appropriate abutment dimensions (→ fig. 12) are provided for each bearing in the product tables. The transition from the bearing seat to the shaft or housing shoulder can be either a simple fillet (→ fig. 13) or an undercut (→ fig. 14). Dimensions for  $r_{amax}$  and  $r_{bmax}$  are listed in the product tables.

Dimensions for undercuts are provided in table 5.

The larger the fillet radius (for the simple form) of the transition to the shaft shoulder, the more favourable is the stress distribution in the shaft fillet area.

Fig. 14

Shaft and housing fillet dimensions, with an undercut

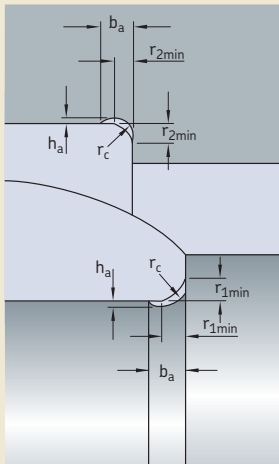

Table 5

### Undercut dimensions

#### Chamfer dimensions      Fillet dimensions

 $r_{1min}, r_{2min}$ 
 $b_a$ 
 $h_a$ 
 $r_c$ 

mm

mm

1

1,1

1,5

2

2,5

3

4

5

6

7,5

2

2,4

3,2

4

4

4,7

5,9

7,4

8,6

10

0,2

0,3

0,4

0,5

0,5

0,5

0,5

0,6

0,6

0,6

1,3

1,5

2

2,5

2,5

3

4

4

6

7

## Location of rod ends

The inner rings of rod ends can be axially located by a shaft shoulder, a nut or a retaining ring.

Rod ends mounted on threaded rods or in extension tubes should be secured by an extra nut on the rod or the external thread of the rod end shank. The nut should be securely tightened against the support surface on the rod end housing or on the tube (→ **fig. 15**).

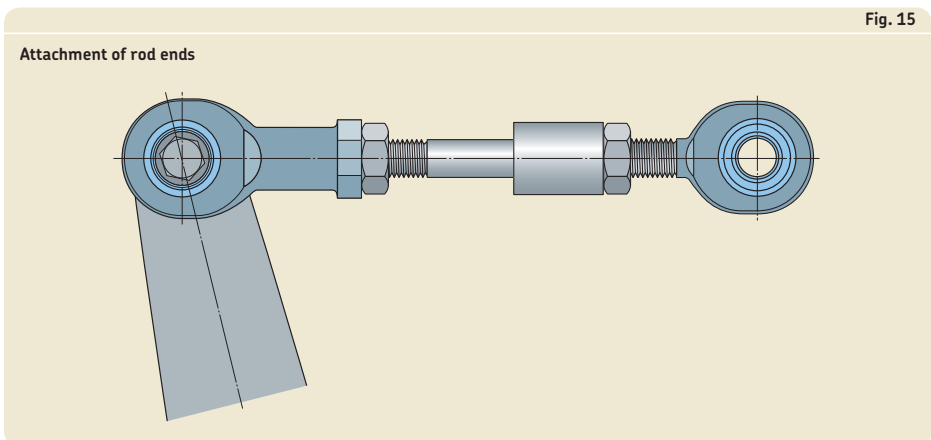



## Sealing

Most bearing arrangements must be sealed to prevent contaminants, such as dirt and moisture, from entering the bearing. The efficiency of the seal has a decisive influence on the service life of the bearing. In contrast to most other bearing types, which only move in one plane, the alignment capabilities of spherical plain bearings place additional demands on the seal.

To select appropriate seals, several factors have to be considered, including:

- the permissible angle of tilt
- the available space
- environmental conditions
- the effectiveness of the seal
- the type of lubricant and the frequency of relubrication
- the justifiable cost

Depending on the application, one or more of the above factors outweigh the others. It is therefore not possible to establish general rules for seal design.

Most SKF radial spherical plain bearing series are available with integral seals. Standard sealed bearings can increase the service life of the bearings and save space, while reducing

inventory and assembly costs. Design characteristics and suitability of the RS seals and the LS heavy-duty seals are provided in **table 6**.

**Table 7** on **pages 80 to 81**, provides an overview of external sealing possibilities, their design characteristics and their suitability to meet different application requirements. SKF supplies most of the external seals introduced in **table 7**.

**NOTE:** SKF additional information about the seals referred to in **table 7** on **pages 80 to 81**, refer to the *SKF Interactive Engineering Catalogue*, available online at [www.skf.com](http://www.skf.com).

SKF also supplies sealing strips made of felt (FS strips) or aluminium-boron silicate (FSB strips) for high temperature applications.

Table 6

### SKF integral seals for spherical plain bearings

| Seal      | Illustration  | Design characteristics  | Suitability  |
|-----------|---|---|--|
| RS design |  | Double-lip contact seal made of <ul style="list-style-type: none"> <li>• polyester elastomer for metric bearings with a bore diameter <math>d &lt; 320</math> mm (<math>-30</math> to <math>+130</math> °C)</li> <li>• acrylonitrile-butadiene rubber for metric bearings with a bore diameter <math>d \geq 320</math> mm (<math>-35</math> to <math>+100</math> °C)</li> <li>• polyurethane for inch bearings (<math>-20</math> to <math>+80</math> °C)</li> </ul> | <ul style="list-style-type: none"> <li>• for compact bearing arrangements, mainly indoors</li> <li>• for cramped spaces</li> <li>• for high sealing demands when combined with an outboard seal</li> <li>• for long service life with minimal maintenance</li> <li>• for arrangements with bearings that rotate</li> </ul> |
| LS design |  | Triple-lip heavy-duty contact seal made of acrylonitrile-butadiene rubber with sheet steel insert ( $-55$ to $+110$ °C, for short periods up to $+125$ °C)  | <ul style="list-style-type: none"> <li>• for compact bearing arrangements</li> <li>• for high sealing demands</li> <li>• for long service life with minimal maintenance</li> <li>• for arrangements with bearings that rotate</li> <li>• for difficult operating conditions in the presence of sand or mud</li> </ul>      |

Table 7

## External seals for spherical plain bearings

| Seal                 | Illustration | Design characteristics  | Suitability   |
|----------------------|--------------|---|---|
| Gap-type             |              | Simple and economic, no wear, simple mounting   | <ul style="list-style-type: none"> <li>• for maintenance-free bearings</li> <li>• for small angles of tilt</li> <li>• for high temperatures</li> <li>• for moderately dusty environments</li> <li>• for arrangements with bearings that rotate</li> </ul>   |
| Gap-type with grease |              | Simple and efficient with periodic relubrication  | <ul style="list-style-type: none"> <li>• for bearings and rod ends requiring maintenance</li> <li>• for small angles of tilt</li> <li>• for rough conditions in the presence of sand, clay, slush etc.</li> </ul>   |
| V-shaped             |              | <p>Simple, lightly preloaded seal made of polyurethane (-40 to +100 °C)</p> <p>Good wear strength and resistance to grease, oil and other environmental influences</p>  | <ul style="list-style-type: none"> <li>• for contaminant exclusion</li> <li>• for angles of tilt up to 2°</li> <li>• for bearing arrangements with shaft diameters up to 300 mm</li> <li>• for arrangements with bearings that rotate</li> </ul>  |
| V-ring               |              | <p>Elastic seal that sits on the shaft and turns with it, axial sealing lip made of acrylonitrile-butadiene rubber (-40 to +100 °C) or fluoro rubber (-40 to +200 °C)</p> <p>Good wear and chemical resistance</p>  | <ul style="list-style-type: none"> <li>• for contaminant exclusion</li> <li>• for maintenance-free and grease-lubricated bearings</li> <li>• for all shaft diameters</li> <li>• for angles of tilt between 2 and 4°, depending on size</li> <li>• for arrangements with bearings that rotate</li> </ul> |
| Felt                 |              | Simple to install, good resistance to grease (-40 to +100 °C)   | <ul style="list-style-type: none"> <li>• for dust and minor dampness exclusion</li> <li>• for grease retention</li> <li>• for large angles of tilt</li> <li>• for all bearing sizes</li> <li>• for arrangements with bearings that rotate</li> </ul>  |
| Radial shaft         |              | <p>Steel reinforced (either externally or internally) elastomer with a acrylonitrile-butadiene rubber lip (-40 to +100 °C) or fluoro rubber lip (-40 to +200 °C)</p> <p>Good wear resistance, good resistance to grease, oil and other environmental influences</p> | <ul style="list-style-type: none"> <li>• for contaminant exclusion</li> <li>• for grease retention</li> <li>• for oil retention</li> <li>• for small angles of tilt</li> <li>• for all bearing sizes</li> <li>• for arrangements with bearings that rotate</li> </ul>                                   |

## External seals for spherical plain bearings

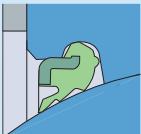
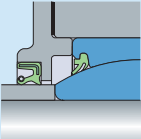
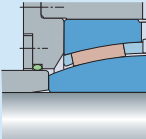
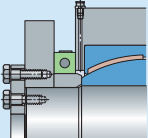
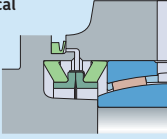
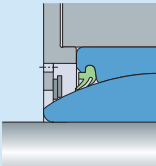
| Seal   | Illustration  | Design characteristics  | Suitability   |
|--|---|---|---|
| <b>Radial shaft with an auxiliary dust lip</b> |    | Steel reinforced (either externally or internally) elastomer with an acrylonitrile-butadiene rubber lip (-40 to +100 °C) or fluoro rubber lip (-40 to +200 °C)<br><br>Good wear resistance, good resistance to grease, oil and other environmental influences | <ul style="list-style-type: none"> <li>• for highly contaminated environments</li> <li>• for oil retention</li> <li>• for small angles of tilt</li> <li>• for bearings with a bore diameter d up to approx. 300 mm</li> <li>• for arrangements with bearings that rotate</li> </ul> |
| <b>O-ring</b>                                  |    | Acrylonitrile-butadiene rubber (-40 to +100 °C) or fluoro rubber (-40 to +200 °C)   | <ul style="list-style-type: none"> <li>• for reliable moisture exclusion</li> <li>• for oil and grease retention</li> <li>• for very small angles of tilt</li> <li>• for slow oscillating movements</li> </ul>  |
| <b>Profiled rubber with clamp and lock</b>     |    | Elastomer strip (-40 to +100 °C)<br><br>Good wear resistance, good resistance to grease, oil and other environmental influences   | <ul style="list-style-type: none"> <li>• for hermetically sealed bearing arrangements</li> <li>• for slow oscillating movements. Initial oiling or greasing of faces reduces friction</li> <li>• for small angles of tilt</li> </ul>  |
| <b>Mechanical seals</b>                        |   | Stainless steel rings and cup springs of acrylonitrile-butadiene rubber (-40 to +100 °C)<br><br>Good wear resistance, good resistance to grease, oil and other environmental influences   | <ul style="list-style-type: none"> <li>• for contaminant exclusion</li> <li>• for oil and grease retention</li> <li>• for small angles of tilt</li> <li>• for arrangements with bearings that rotate</li> </ul>   |
| <b>Spring steel washers</b>                    |  | Set of washers for high temperatures. Excellent wear resistance, good chemical resistance   | <ul style="list-style-type: none"> <li>• for contaminant exclusion</li> <li>• grease exit vents needed in housing cover if grease used</li> <li>• for small angles of tilt</li> <li>• for arrangements with bearings that rotate</li> </ul>   |

**WARNING!**

Some of the external seals listed in this table can be made of fluoro rubber. Note that fluoro rubber gives off dangerous fumes at temperatures above 300 °C and can be hazardous if touched. As handling seals made of fluoro rubber constitutes a potential safety risk, the safety precautions must always be followed. For detailed information about the safety precautions, refer to the *SKF Interactive Engineering Catalogue*, available online at [www.skf.com](http://www.skf.com), the *SKF General Catalogue* or the publication *Industrial shaft seals*.

## Designing a bearing arrangement for easy mounting and dismounting

To facilitate mounting, the shaft ends and housing bores should have a 10 to 20 degree lead-in chamfer (→ **fig. 16**). This is particularly important for applications using larger bearings, as the rings may skew, causing damage to the mating surfaces.

To facilitate the use of withdrawal tools when removing bearings, it can be advantageous to:

- provide recesses in the shaft shoulder (→ **fig. 17**)
- provide recesses or threaded holes in the housing bore (→ **fig. 18**)

To dismount larger maintenance-free bearings with a bore diameter  $d \geq 80$  mm that have a tight shaft fit, SKF recommends using the oil injection method. With the oil injection method, oil under high pressure is injected between the bearing inner ring and its shaft seat to form an oil film. This oil film separates the mating surfaces, greatly reducing the force required to dismount the bearing and virtually eliminating any risk of damage to the bearing or shaft.

To use the oil injection method, there must be an oil supply duct in the shaft as well as an oil distribution groove in the seat (→ **fig. 19**). As a general rule, the distance between the groove and the bearing side face from which mounting and dismounting are to be performed should be approximately one third of the seat width (→ **fig. 19**). Recommended dimensions for the ducts and grooves as well as for the threads for the oil supply connection are provided in **tables 8** and **9**.

Fig. 16

Chamfering shaft ends and housing bore entrances

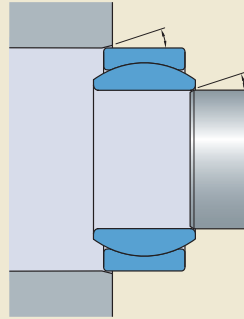

Fig. 17

Shaft shoulder with a recess

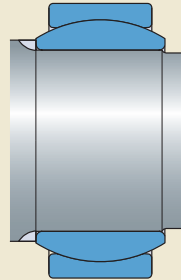

Fig. 18

Housing shoulder with threaded holes

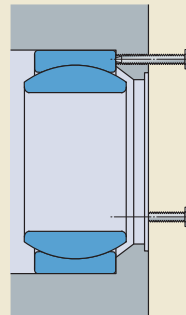
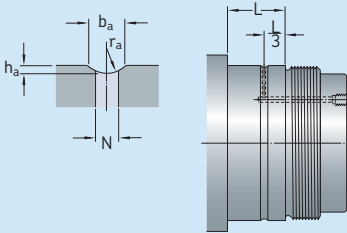

Table 8

Recommended dimensions for oil supply ducts and distribution grooves



| Bearing seat diameter |       | Dimensions |       |       |     |
|-----------------------|-------|------------|-------|-------|-----|
| over                  | incl. | $b_a$      | $h_a$ | $r_a$ | N   |
| mm                    |       | mm         |       |       |     |
| –                     | 100   | 3          | 0,5   | 2,5   | 2,5 |
| 100                   | 150   | 4          | 0,8   | 3     | 3   |
| 150                   | 200   | 4          | 0,8   | 3     | 3   |
| 200                   | 250   | 5          | 1     | 4     | 4   |
| 250                   | 300   | 5          | 1     | 4     | 4   |
| 300                   | 400   | 6          | 1,25  | 4,5   | 5   |
| 400                   | 500   | 7          | 1,5   | 5     | 5   |
| 500                   | 650   | 8          | 1,5   | 6     | 6   |
| 650                   | 800   | 10         | 2     | 7     | 7   |
| 800                   | 1 000 | 12         | 2,5   | 8     | 8   |

L = width of bearing seat.

Table 9

Design and recommended dimensions for threaded holes for connecting oil supply

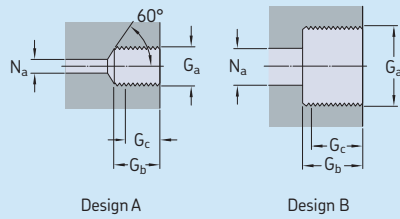

| Thread | Design | Dimensions |            |              |
|--------|--------|------------|------------|--------------|
|        |        | $G_b$      | $G_c^{1)}$ | $N_a$<br>max |
| –      |        | mm         |            |              |
| M6     | A      | 10         | 8          | 3            |
| G 1/8  | A      | 12         | 10         | 3            |
| G 1/4  | A      | 15         | 12         | 5            |
| G 3/8  | B      | 15         | 12         | 8            |
| G 1/2  | B      | 18         | 14         | 8            |
| G 3/4  | B      | 20         | 16         | 8            |

<sup>1)</sup> Effective threaded length.

Fig. 19

Shaft with oil ducts and a distribution groove to facilitate dismounting

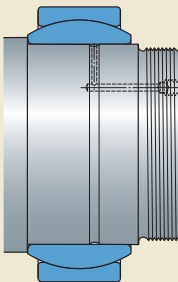

# Lubrication

## The SKF traffic light concept

Most grease suppliers indicate the specific values for the low and high temperature limits in their product information. The SKF traffic light concept is distinctly different from that. SKF recognizes that the really important temperatures for reliable operation lie within a smaller range. This range depends largely on the type of base oil and thickener used as well as the additives. The relevant temperatures are given by the SKF traffic light concept. They are schematically illustrated in **diagrams 1** and **2** in the form of a double traffic light.

It is evident that grease in the red zones should not be applied at all, as damage may occur. Within the green zone the grease functions reliably, and the grease life can be determined accurately.

At temperatures in the amber zone above the high temperature performance limit (HTPL), grease ages and oxidize with increasing rapidity and the by-products of the oxidation have a detrimental effect on lubrication. An amber zone also exists for low temperatures. Short periods in this zone, e.g. during a cold start, are not harmful since the heat caused by friction brings the bearing temperature into the green zone.

### The SKF traffic light concept – general

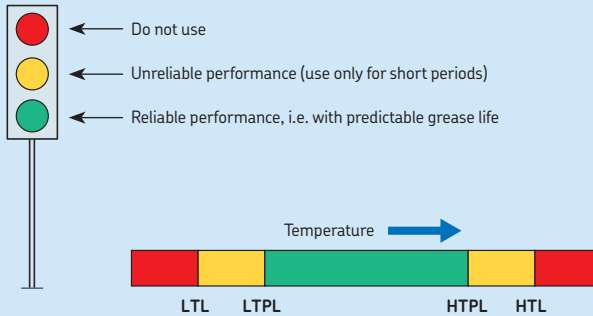

#### LTL – Low temperature limit

This limit indicates the lowest temperature at which the grease allows the bearing to be started up without difficulty.

#### LTPL – Low temperature performance limit

Below this limit, the supply of grease to the contact surfaces becomes insufficient.

#### HTPL – High temperature performance limit

Above this limit, the grease ages and oxidize in an uncontrolled way, so that grease life cannot be determined accurately.

#### HTL – High temperature limit

When exceeding this limit, the grease loses its structure permanently.

### The SKF traffic light concept – temperature limits for SKF greases when used in spherical plain bearings requiring maintenance

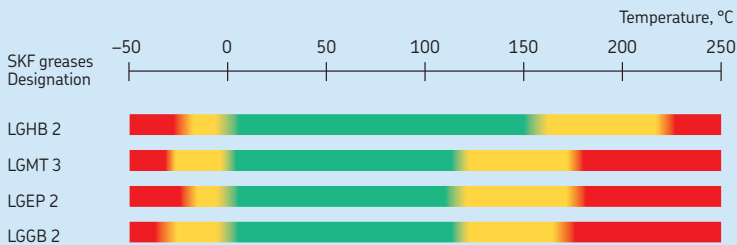

Fig. 1

Relubricating the bearing via the outer ring

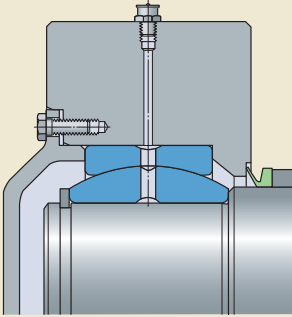

Fig. 2

Relubricating the bearing via the inner ring

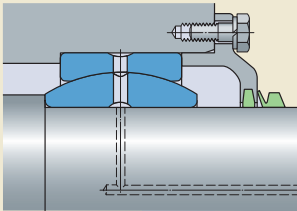
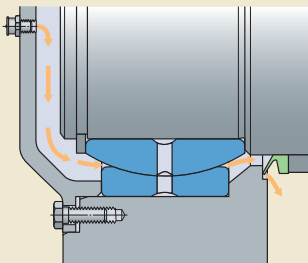

Fig. 3

Relubricating the bearing from the side



## Spherical plain bearings requiring maintenance

Steel/steel radial spherical plain bearings must be relubricated to:

- reduce friction
- reduce wear
- extend bearing service life
- protect against corrosion and contaminants

The sliding contact surfaces are phosphated and treated with a “running-in” lubricant. This special surface treatment has a favourable influence during the running-in phase. The bearings must be greased prior to use and relubricated on a regular basis.

To reliably relubricate the bearings, grease ducts should be provided in the housing (→ fig. 1) or shaft (→ fig. 2) so that fresh grease can be supplied directly to the bearing. All SKF steel/steel radial spherical plain bearings (with the exception of the smallest E and ESA design bearings) have an annular groove and lubrication holes in both the inner and outer rings to facilitate lubricant distribution to the sliding surfaces of the bearing.

If the arrangement is appropriately designed, the bearing can also be supplied with grease from the side. To facilitate the passing of grease through the bearing, the grease should be prevented from exiting the bearing arrangement from the side it is supplied, e.g. by an end cover, and to provide an opening for the grease to exit on the opposite side, e.g. a V-ring seal that can open if there is pressure from the inside (→ fig. 3).

Generally, where possible, the free space surrounding the bearing should be filled with grease.



SKF recommends using SKF LGHB 2 grease to lubricate steel/steel spherical plain bearings. Its properties include:

- excellent performance under heavy loads
- very good rust inhibitor
- very good resistance to ageing
- good water resistance
- a wide operating temperature range.

If operating temperatures exceed the temperature range limits, special grease should be used (→ **table 1**).

For additional information, contact the SKF application engineering service.

**Table 1**

**SKF grease recommendations**

| Property  | SKF greases (designation)   |                        | LGEP 2<br>steel/PTFE FRP | LGGB 21)<br>steel/PTFE FRP |
|---|---|------------------------|--------------------------|----------------------------|
|   | LGHB 2<br>for sliding contact surface combinations<br>steel/steel | LGMT 3<br>steel/bronze |                          |                            |
| <b>Thickener</b>  | Calcium sulphonate complex soap                                   | Lithium soap           | Lithium soap             | Lithium/calcium soap       |
| <b>Base oil</b>   | Mineral oil   | Mineral oil            | Mineral oil              | Ester oil                  |
| <b>Colour</b>   | Brown   | Yellowish brown        | Light brown              | White                      |
| <b>Temperature range<sup>2)</sup>, °C</b><br>LTL to HTPL                            | -20 to +150   | -30 to +120            | -20 to +110              | -40 to +120                |
| <b>Kinematic viscosity of base oil, mm<sup>2</sup>/s</b><br>at +40 °C<br>at +100 °C | 400 to 450<br>26,5  | 120 to 130<br>12       | 200<br>16                | 110<br>13                  |
| <b>Consistency</b><br>(to NLGI Scale)   | 2   | 3                      | 2                        | 2                          |

<sup>1)</sup> Grease biologically degradable, for use in applications where strict ecological demands must be met and where lubrication cannot be dispensed with.

<sup>2)</sup> Refer to the SKF traffic light concept, starting on **page 84**.

## Maintenance-free spherical plain bearings

### Steel/PTFE sintered bronze and steel/PTFE fabric sliding contact surface combinations

During operation, PTFE is transferred from the dry sliding contact surface of the outer ring to the hard chromium plated steel surface of the inner ring. Any external lubricant on the sliding contact surfaces would disturb this self-lubrication and shorten bearing service life.

As a result, these bearings must not be lubricated and do not have any relubrication facility.

### Steel/PTFE FRP sliding contact surface combination

Bearings with this sliding contact surface combination are also self-lubricating and can be operated grease-free.

However, initial lubrication followed by occasional relubrication of steel/PTFE FRP bearings can extend the service life of the bearing by a factor of two or more. The inner rings of radial bearings or shaft washers of angular contact and thrust bearings are coated with a lithium base grease before leaving the factory.

If operating conditions are such that protection against corrosion and enhanced sealing are required, the free space surrounding the bearing (→ **fig. 4**) can be filled with the same grease that was used to lubricate the bearing. The appropriate time to replenish or renew the grease in the bearing arrangement is determined by the operating conditions and the ageing of the grease.

Rust inhibiting, water-repellent lithium base greases with a consistency of 2 on the NGLI scale should be used. SKF recommends SKF LGEP 2 grease (→ **table 1 on page 87**). Greases containing molybdenum disulphide or other solid lubricants should never be used.

**CAUTION:** Depending on their design, SKF spherical plain bearings are either completely or partially coated with an oily preservative or filled with grease. Avoid skin contact as these substances may cause skin irritation or an allergic reaction.

Fig. 4

Relubricating the bearing from the side

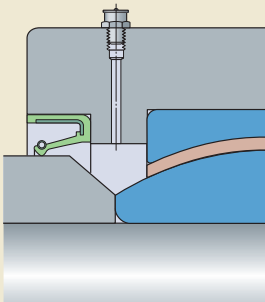

## Rod ends requiring maintenance

Steel/steel and steel/bronze rod ends require lubrication. To facilitate this:

- All SKF steel/steel rod ends, with the exception of small-sized E and ESA design rod ends, can be relubricated via a lubrication hole or grease fitting in the rod end housing as well as via the pin and the inner ring (→ **fig. 5**).
- All SKF steel/bronze rod ends can be relubricated via a lubrication hole or grease fitting in the rod end housing (→ **fig. 6**).

The general recommendations for steel/steel radial spherical plain bearings also apply to steel/steel rod ends as well as steel/bronze rod ends.

For steel/bronze rod ends in the SIKAC .. M and SAKAC .. M series, SKF recommends SKF LGMT 3 grease (→ **table 1** on **page 87**). Lithium based greases with a normal consistency without solid lubricant additives can also be used.

## Maintenance-free rod ends

Maintenance-free, self-lubricating rod ends are designed to be used as dry sliding bearings and must not be lubricated. Consequently, these rod ends do not have a relubrication facility in their housings.

Steel/PTFE FRP rod ends are an exception. They can be used without additional lubricant, but their service life can be extended appreciably if they are lubricated prior to use.

**CAUTION:** Depending on their design, SKF rod ends are either completely or partially coated with an oily preservative or filled with grease. Avoid skin contact as these substances may cause skin irritation or an allergic reaction.

Fig. 5

### Relubrication facilities for steel/steel rod ends

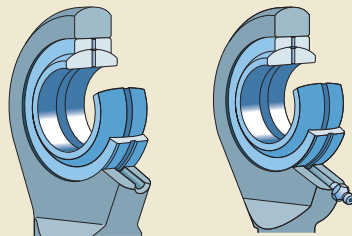

Lubrication hole

Grease fitting

Fig. 6

### Relubrication facilities for steel/bronze rod ends (sizes 6 and larger)

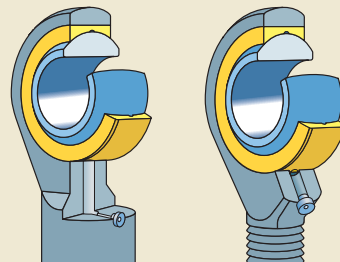

SIKAC .. M series

SAKAC .. M series

# Relubrication

To maximize the service life of spherical plain bearings and rod ends requiring maintenance, they must be relubricated on a regular basis. This also applies to maintenance-free bearings with a steel/PTFE FRP sliding contact surface. Used grease containing wear debris and contaminants should be removed from the contact zone and replaced with fresh grease.

Determining the proper relubrication interval is extremely important because the attainable service life depends on several factors including:

- the magnitude of the load
- the type of load
- the angle of oscillation
- the frequency of oscillation
- the operating temperature
- the sealing arrangement
- other environmental conditions

Long bearing service life can be attained when the following basic relubrication rules are observed:

- the same type of grease is always used (→ **table 1** on **page 87**)
- the lubricant is applied at operating temperature
- the lubricant is applied before a long interruption, e.g. before construction or agricultural equipment is stored

## Relubrication of non-locating bearings

Non-locating bearings, where axial displacement takes place along the shaft or pin, should always be relubricated via the shaft and bearing inner ring (→ **fig 2** on **page 86**). By supplying lubricant in this way, grease also enters between the mating surfaces of the inner ring and shaft seat. This reduces friction and induced axial loads when axial displacement occurs.

## Storage

SKF spherical plain bearings and rod ends are treated with a preservative before they are packaged. They can, therefore, be stored in their original packages for several years. However, the relative humidity in the storeroom should not exceed 60%.

**NOTE:** SKF also supplies a comprehensive assortment of greases for various application requirements. For additional information, refer to the catalogue *SKF Maintenance and Lubrication Products* or online at [www.mapro.skf.com](http://www.mapro.skf.com).



SKF has the appropriate greases for spherical plain bearings and rod ends, including the biologically degradable SKF LGGB 2 grease

# Mounting

Skill and cleanliness when mounting are necessary if spherical plain bearings and rod ends are to achieve maximum service life and not fail prematurely.

Bearings and rod ends should only be removed from their packages immediately prior to mounting so that they do not become contaminated. Bearing components that could have become dirty as a result of improper handling or damaged packaging should be wiped clean with a lint-free cloth.

The sliding contact surfaces of spherical plain bearings are matched to provide favourable friction and wear characteristics. Therefore, any alteration of the sliding surfaces can reduce bearing service life. Alterations in this context also include washing or exposing the sliding surfaces to solvents, cleaners, oils or similar media.

All associated components should be clean and free of any burrs. Also make sure to check each associated component for dimensional accuracy before the installation process is started.

## Spherical plain bearings

When mounting spherical plain bearings with a fractured or split outer ring, it is essential that the joint is positioned at 90° to the direction of load (→ **fig. 1**), otherwise service life is reduced.

Steel or plastic bands that hold together spherical plain bearing outer rings must not be removed prior to mounting. They are positioned in an annular groove and do not protrude from the outside diameter surface.

Spherical plain bearing outer rings that are axially split and bolted together must be mounted as such, without loosening the bolts.

## Mechanical mounting

The following tools are suitable for mounting spherical plain bearings:

- a mounting dolly (→ **fig. 2**) or length of tubing; the ring with an interference fit should generally be mounted first
- a dolly having two abutment surfaces (→ **fig. 3**) for simultaneously mounting the bearing on the shaft and in the housing
- for larger numbers of bearings, suitable tools can be used in combination with a press (→ **fig. 4**)

When mounting spherical plain bearings, consider the following:

- Never use a hammer or pin punch to drive a bearing in place, as either could damage the rings (→ **fig. 5**).
- The mounting force should never be directed through the sliding contact surfaces (→ **fig. 6**). This could damage the sliding contact surfaces and/or expand fractured or split bearing outer rings, which can cause an increase in the mounting force required.

Fig. 1

Plane of fracture or split and main direction of load

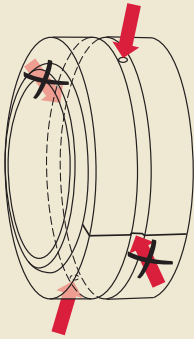

Fig. 2

Mounting with the aid of a dolly

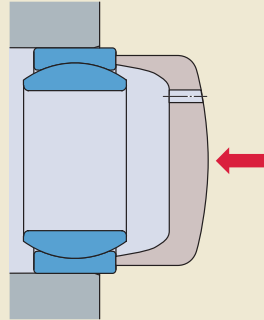

Fig. 3

Simultaneous mounting in the housing and on the shaft

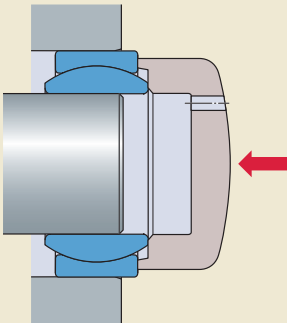

Fig. 4

Mounting using a press

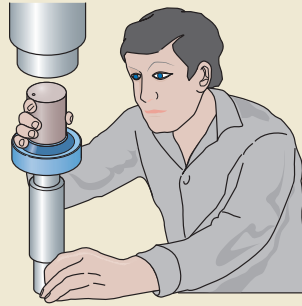

Fig. 5

Never hit the bearing rings directly

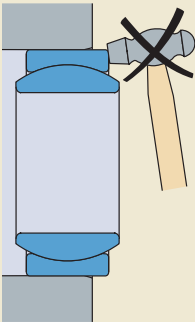
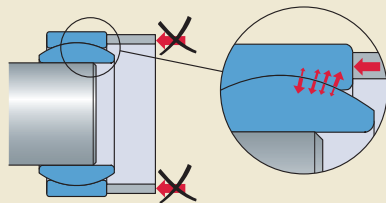

Fig. 6

Never apply the mounting force via the sliding contact surfaces



## Mounting

### Hot mounting

As a rule, larger bearings cannot be mounted cold because the force required to press a bearing into position increases considerably with its size. Therefore, SKF recommends the following:

- heat the bearing before it is mounted on the shaft (→ **fig. 7**)
- heat non-split housings before inserting the bearing

To mount a bearing on a shaft, a temperature differential of 60 to 80 °C between ambient temperature and the heated inner ring, is usually sufficient. For housings, the appropriate differential depends on the degree of interference and the seat diameter. However, a moderate

increase in temperature is usually sufficient. When heating the bearing, do not exceed the temperature limit of any associated components, such as the seals.

For an even and risk-free heat source, an induction heater should be used. The use of an SKF induction heater has a number of advantages. It heats the bearing rapidly and a built-in thermostat prevents overheating. The non-metallic components, such as the seals or PTFE fabric, remain cold as does the heater itself. SKF induction heaters automatically demagnetize the bearing after it has been heated.

Mounting bearings by cooling the shaft or the bearing is not recommended, as the very low temperatures required inevitably cause condensation, thus creating the risk of corrosion.

To ease the mounting of large bearings, particularly if they have been heated, it is possible to use slings and a hoist. Metal or textile slings placed around the outer ring can be used. A spring between the hoist hook and the sling also facilitates bearing handling (→ **fig. 8**).

Fig. 7

#### Mounting a heated bearing

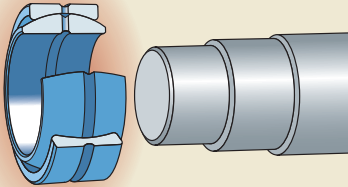
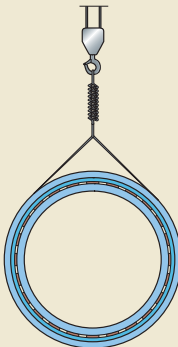

Fig. 8

#### Mounting a heated large bearing



#### WARNING!

Maintenance-free spherical plain bearings and rod ends must never be subjected to temperatures in excess of +280 °C due to the PTFE content. PTFE is completely inert below this temperature but at higher temperatures (from approx. 320 °C) it rapidly decomposes. The fluorine compounds released during this process are extremely toxic, even in small quantities, and can cause serious injury. It should also be remembered that the material is dangerous to handle once it has been overheated, even after it has cooled.

Heat-resistant gloves should be worn when handling hot components.



## Rod ends

Rod ends are fitted on pins and shafts in the same way as spherical plain bearings. Slight heating reduces the force required for mounting and reduce the risk of damaging associated components.

When attaching rod ends to threaded rods or extension tubes (→ **fig. 9**) a counter lock nut should be used on the rod or on the external thread of the rod end. It should be securely tightened against the abutment surface on the rod end or tube.

**NOTE:** SKF supplies a comprehensive range of mechanical and hydraulic tools as well as heating equipment for bearing mounting and dismounting. For additional information, refer to the catalogue *SKF Maintenance and Lubrication Products* or online at [www.mapro.skf.com](http://www.mapro.skf.com).

Fig. 9

Securing a rod end with a right-hand thread

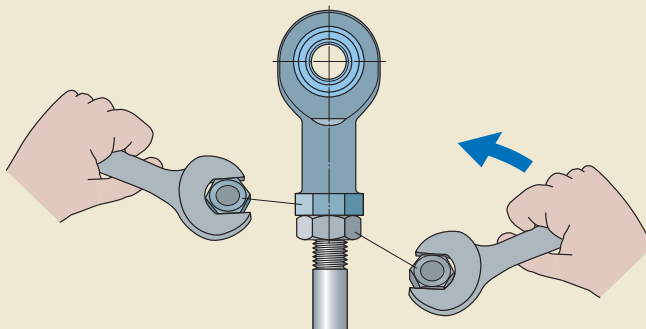

# Dismounting

## Spherical plain bearings

If bearings are to be re-used after dismounting, the same care and attention are required during dismounting as when mounting. The requisite withdrawal force should always be applied to the ring which is being dismounted.

SKF offers an assortment of different pullers to accommodate many applications. If the shaft is pre-machined to accommodate the arms of a jaw puller, then a two- or three-armed puller can be used (→ **fig. 1**).

In other cases where there is enough space behind the ring, a strong back puller such as the SKF TMBS series can be used (→ **fig. 2**).

For large bearings with an interference fit, dismounting is considerably facilitated if the SKF oil injection method is used (→ **fig. 3**). The oil ducts and distributor grooves should be provided when designing the bearing arrangement (→ **page 82**).

Small bearings can be dismounted using a mounting dolly or a length of tubing applied to the outer ring. For larger bearings with an interference fit, a mechanical or hydraulic press should be used when possible.

It is also possible to dismount a bearing from the housing bore by quickly heating the housing without heating the bearing outer ring to any extent.

## Rod ends

To dismount rod ends, the lock nut securing the shank should be loosened and, if possible, the rod end should be unscrewed from its rod or tube. The rod end can then be removed from the pin or shaft in the same way as a bearing, e.g. using a puller or a press.

Fig. 1

Removing a bearing with a jaw puller

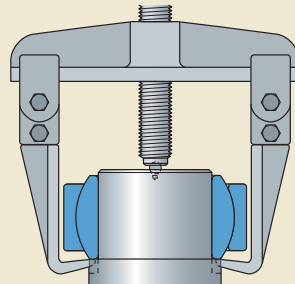

Fig. 2

A strong back puller facilitates dismounting of the inner ring

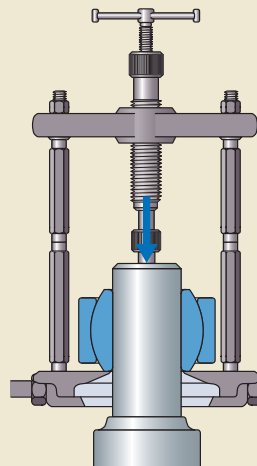
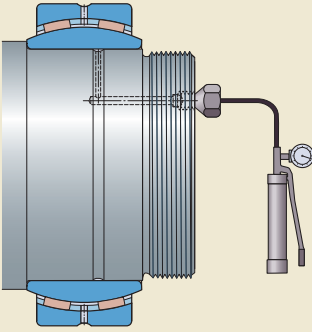

Fig. 3

Dismounting a bearing using the SKF oil injection method





# Radial spherical plain bearings requiring maintenance

|  |            |
|--|------------|
| Dimensions .....   | 100        |
| Tolerances .....   | 101        |
| Radial internal clearance.....   | 102        |
| Materials .....  | 102        |
| Permissible operating temperature range .....  | 102        |
| <b>Product tables .....</b>  | <b>104</b> |
| 2.1 Radial spherical plain bearings, steel/steel, metric sizes.....                            | 104        |
| 2.2 Radial spherical plain bearings, steel/steel, inch sizes .....                             | 110        |
| 2.3 Radial spherical plain bearings with an extended inner ring, steel/steel, metric sizes ..  | 116        |
| 2.4 Radial spherical plain bearings with an extended inner ring, steel/steel, inch sizes ..... | 120        |

## Radial spherical plain bearings requiring maintenance

A characteristic feature of SKF steel/steel radial spherical plain bearings is the outer ring, which is intentionally fractured so that it can be sprung apart to enable the inner ring to be inserted (→ **fig. 1**). The bearings are therefore non-separable and easy to handle.

The bearings are manganese phosphated and the sliding contact surface is then treated with a running-in lubricant. This reduces friction and wear during the running-in period. To facilitate lubrication, all bearings, with the exception of some small sizes, have an annular groove and two lubrication holes in both the inner and outer rings. Metric bearings with an outside diameter  $D \geq 150$  mm also have the SKF multi-groove system (→ **page 17**) in the outer ring sliding contact surface as standard (→ **fig. 2**). Upon request, SKF can also supply smaller metric and inch size bearings with the multi-groove system.

With the multi-groove system, SKF solved the problem of lubricant starvation in steel/steel bearings. Lubricant starvation is a common cause of premature bearing failure in applications where minor alignment movements are made under heavy, constant direction loads.

The multi-groove system improves lubricant distribution in the heavily loaded zone to extend bearing service life and/or maintenance intervals.

### Dimensions

The dimensions of spherical plain bearings in the GE, GEH and GEG series are in accordance with ISO 12240-1:1998.

Bearings in the GEM series, which have an extended inner ring, have a non-standard inner ring width, but otherwise have the same dimensions as GE series bearings.

Inch spherical plain bearings in the GEZ series are in accordance with the American Standard ANSI/ABMA Std. 22.2-1988.

Fig. 1

The fractured outer ring enables the bearing to be assembled

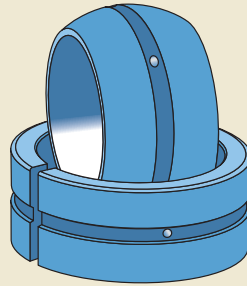

Fig. 2

Spherical plain bearing with the multi-groove system in the outer ring



Fig. 3

Spherical plain bearing with the multi-groove system, fitted with LS heavy-duty seals

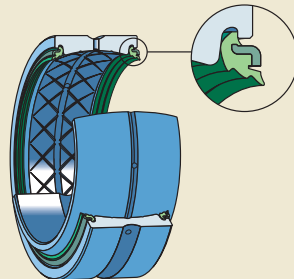

## Tolerances

The dimensional tolerances for metric radial spherical plain bearings requiring maintenance in the GE, GEG, GEH and GEM series are listed in **table 1**. The dimensional tolerances for inch radial spherical plain bearings in the GEZ, GEZH and GEZM series are listed in **table 2** on **page 103**. Outer ring tolerances apply to conditions before fracture and surface treatment. Accordingly, inner ring tolerances apply to rings before surface treatment.

The tolerances are in accordance with ISO 12240-1:1998 (metric bearings) and ANSI/ABMA Std. 22.2-1988 (inch bearings).

The symbols used in the tolerance tables are explained in the following:

- d nominal bore diameter
- $\Delta_{dmp}$  deviation of the mean bore diameter from the nominal
- D nominal outside diameter
- $\Delta_{Dmp}$  deviation of the mean outside diameter from the nominal
- $\Delta_{Bs}$  deviation of the single inner ring width from the nominal
- $\Delta_{Cs}$  deviation of the single outer ring width from the nominal

**Table 1**
**Dimensional tolerances for metric radial spherical plain bearings requiring maintenance**

| Nominal diameter |            | GE, GEH and GEM series |     |                    |      | GEG series          |     |                    |      | All series          |     |                    |      |
|------------------|------------|------------------------|-----|--------------------|------|---------------------|-----|--------------------|------|---------------------|-----|--------------------|------|
| d, D over        |            | Inner ring             |     | Inner ring         |      | Inner ring          |     | Inner ring         |      | Outer ring          |     | Outer ring         |      |
| incl.            |            | $\Delta_{dmp}$ high    | low | $\Delta_{Bs}$ high | low  | $\Delta_{dmp}$ high | low | $\Delta_{Bs}$ high | low  | $\Delta_{dmp}$ high | low | $\Delta_{Cs}$ high | low  |
| mm               |            | $\mu\text{m}$          |     | $\mu\text{m}$      |      | $\mu\text{m}$       |     | $\mu\text{m}$      |      | $\mu\text{m}$       |     | $\mu\text{m}$      |      |
| –                | <b>6</b>   | 0                      | –8  | 0                  | –120 | –                   | –   | –                  | –    | –                   | –   | –                  | –    |
| <b>6</b>         | <b>10</b>  | 0                      | –8  | 0                  | –120 | –                   | –   | –                  | –    | 0                   | –8  | 0                  | –240 |
| <b>10</b>        | <b>18</b>  | 0                      | –8  | 0                  | –120 | +18                 | 0   | 0                  | –180 | 0                   | –8  | 0                  | –240 |
| <b>18</b>        | <b>30</b>  | 0                      | –10 | 0                  | –120 | +21                 | 0   | 0                  | –210 | 0                   | –9  | 0                  | –240 |
| <b>30</b>        | <b>50</b>  | 0                      | –12 | 0                  | –120 | +25                 | 0   | 0                  | –250 | 0                   | –11 | 0                  | –240 |
| <b>50</b>        | <b>80</b>  | 0                      | –15 | 0                  | –150 | +30                 | 0   | 0                  | –300 | 0                   | –13 | 0                  | –300 |
| <b>80</b>        | <b>120</b> | 0                      | –20 | 0                  | –200 | +35                 | 0   | 0                  | –350 | 0                   | –15 | 0                  | –400 |
| <b>120</b>       | <b>150</b> | 0                      | –25 | 0                  | –250 | +40                 | 0   | 0                  | –400 | 0                   | –18 | 0                  | –500 |
| <b>150</b>       | <b>180</b> | 0                      | –25 | 0                  | –250 | +40                 | 0   | 0                  | –400 | 0                   | –25 | 0                  | –500 |
| <b>180</b>       | <b>250</b> | 0                      | –30 | 0                  | –300 | +46                 | 0   | 0                  | –460 | 0                   | –30 | 0                  | –600 |
| <b>250</b>       | <b>315</b> | 0                      | –35 | 0                  | –350 | –                   | –   | –                  | –    | 0                   | –35 | 0                  | –700 |
| <b>315</b>       | <b>400</b> | –                      | –   | –                  | –    | –                   | –   | –                  | –    | 0                   | –40 | 0                  | –800 |
| <b>400</b>       | <b>500</b> | –                      | –   | –                  | –    | –                   | –   | –                  | –    | 0                   | –45 | 0                  | –900 |

## Radial spherical plain bearings requiring maintenance

### Radial internal clearance

Steel/steel radial spherical plain bearings are produced with Normal radial internal clearance as standard. The actual values are listed in **tables 3 and 4**. Prior to ordering, check availability of bearings with a smaller (C2) or larger (C3) radial internal clearance than Normal.

The clearance values for metric bearings are in accordance with ISO 12240-1:1998.

### Materials

The inner and outer rings of SKF steel/steel radial spherical plain bearings are made of bearing steel. They are through-hardened, ground and phosphated. The sliding contact surfaces are treated with a running-in lubricant.

Depending on the bore diameter, metric bearings with a 2RS suffix have a double-lip seal made of a polyester elastomer or acrylonitrile-butadiene rubber on both sides of the bearing (→ **table 6 on page 79**). Inch bearings with a 2RS suffix have a double-lip seal made of polyurethane on both sides of the bearing.

Metric and inch bearings with the designation suffix -2LS have a sheet steel reinforced, triple-lip heavy-duty seal made of acrylonitrile-butadiene on both sides of the bearing.

### Permissible operating temperature range

Open steel/steel radial spherical plain bearings have a permissible operating temperature range of  $-50$  to  $+200$  °C, but their load carrying capacity is reduced at temperatures above  $+120$  °C. Bearings for higher temperature applications up to  $300$  °C, can be produced on request.

For sealed bearings, the permissible operating temperature range is limited by the seal material:

- $-20$  to  $+80$  °C for inch RS seals
- $-30$  to  $+130$  °C for metric RS seals with a bore diameter  $d < 320$  mm
- $-35$  to  $+100$  °C for metric RS seals with a bore diameter  $d \geq 320$  mm
- $-55$  to  $+110$  °C for LS seals

The operating temperature range of the grease used to lubricate the bearings must also be taken into consideration.



Table 2

## Dimensional tolerances for inch bearings

| Nominal diameter |        | GEZ, GEZH and GEZM series |     |               |      | Outer ring     |     | $\Delta_{Cs}$ |      |
|------------------|--------|---------------------------|-----|---------------|------|----------------|-----|---------------|------|
| d, D<br>over     | incl.  | Inner ring                |     | $\Delta_{Bs}$ |      | $\Delta_{Dmp}$ |     | high low      |      |
|                  |        | $\Delta_{imp}$<br>high    | low | high          | low  | high           | low | high          | low  |
| in               |        | $\mu\text{m}$             |     |               |      |                |     |               |      |
| –                | 2      | 0                         | –13 | 0             | –130 | 0              | –13 | 0             | –130 |
| 2                | 3      | 0                         | –15 | 0             | –130 | 0              | –15 | 0             | –130 |
| 3                | 3.1875 | 0                         | –20 | 0             | –130 | 0              | –15 | 0             | –130 |
| 3.1875           | 4.75   | 0                         | –20 | 0             | –130 | 0              | –20 | 0             | –130 |
| 4.75             | 6      | 0                         | –25 | 0             | –130 | 0              | –25 | 0             | –130 |
| 6                | 7      | –                         | –   | –             | –    | 0              | –25 | 0             | –130 |
| 7                | 8.75   | –                         | –   | –             | –    | 0              | –30 | 0             | –130 |

Table 3

## Radial internal clearance for steel/steel radial spherical plain bearings, metric sizes

| Bore diameter |       | Radial internal clearance |     |        |     | C3  |     |
|---------------|-------|---------------------------|-----|--------|-----|-----|-----|
| d<br>over     | incl. | C2                        |     | Normal |     | min | max |
|               |       | min                       | max | min    | max | min | max |
| mm            |       | $\mu\text{m}$             |     |        |     |     |     |
| –             | 12    | 8                         | 32  | 32     | 68  | 68  | 104 |
| 12            | 20    | 10                        | 40  | 40     | 82  | 82  | 124 |
| 20            | 35    | 12                        | 50  | 50     | 100 | 100 | 150 |
| 35            | 60    | 15                        | 60  | 60     | 120 | 120 | 180 |
| 60            | 90    | 18                        | 72  | 72     | 142 | 142 | 212 |
| 90            | 140   | 18                        | 85  | 85     | 165 | 165 | 245 |
| 140           | 200   | 18                        | 100 | 100    | 192 | 192 | 284 |
| 200           | 240   | 18                        | 110 | 110    | 214 | 214 | 318 |
| 240           | 300   | 18                        | 125 | 125    | 239 | 239 | 353 |

Bearings in the GEH series, with a bore diameter  $d = 20, 35, 60$  and  $90$  mm, have a radial internal clearance range corresponding to the next larger diameter range.

Table 4

## Radial internal clearance for steel/steel radial spherical plain bearings, inch sizes

| Bore diameter |       | Radial internal clearance |     |        |     | C3  |     |
|---------------|-------|---------------------------|-----|--------|-----|-----|-----|
| d<br>over     | incl. | C2                        |     | Normal |     | min | max |
|               |       | min                       | max | min    | max | min | max |
| in            |       | $\mu\text{m}$             |     |        |     |     |     |
| –             | 0.625 | 15                        | 75  | 50     | 150 | 150 | 200 |
| 0.625         | 2     | 25                        | 105 | 80     | 180 | 180 | 260 |
| 2             | 3     | 30                        | 130 | 100    | 200 | 200 | 300 |
| 3             | 6     | 40                        | 160 | 130    | 230 | 230 | 350 |

# Radial spherical plain bearings, steel/steel, metric sizes

d 4 – 40 mm

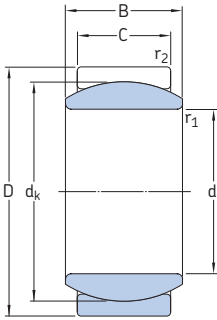

GE..E

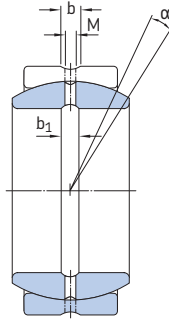

GE..ES

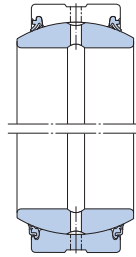

GE..ES-2RS  
GE..ES-2LS

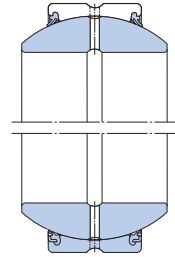

GEH..ES-2RS  
GEH..ES-2LS

| Principal dimensions |    |    |    | Angle of tilt <sup>1)</sup><br>$\alpha$ | Basic load ratings |                          | Mass  | Designations <sup>2)</sup> |                      |
|----------------------|----|----|----|---|--------------------|--------------------------|-------|----------------------------|----------------------|
| d                    | D  | B  | C  |   | dynamic<br>C       | static<br>C <sub>0</sub> |       | without seals              | with standards seals |
| mm                   |    |    |    | degrees                                 | kN                 |                          | kg    | -                          |                      |
| 4                    | 12 | 5  | 3  | 16                                      | 2,04               | 10,2                     | 0,003 | GE 4 E                     | -                    |
| 5                    | 14 | 6  | 4  | 13                                      | 3,4                | 17                       | 0,004 | GE 5 E                     | -                    |
| 6                    | 14 | 6  | 4  | 13                                      | 3,4                | 17                       | 0,004 | GE 6 E                     | -                    |
| 8                    | 16 | 8  | 5  | 15                                      | 5,5                | 27,5                     | 0,008 | GE 8 E                     | -                    |
| 10                   | 19 | 9  | 6  | 12                                      | 8,15               | 40,5                     | 0,012 | GE 10 E                    | -                    |
| 12                   | 22 | 10 | 7  | 10                                      | 10,8               | 54                       | 0,017 | GE 12 E                    | -                    |
| 15                   | 26 | 12 | 9  | 8                                       | 17                 | 85                       | 0,032 | GE 15 ES                   | -                    |
|                      | 26 | 12 | 9  | 8                                       | 17                 | 85                       | 0,032 | GE 15 ES-2RS               | -                    |
| 17                   | 30 | 14 | 10 | 10                                      | 21,2               | 106                      | 0,050 | GE 17 ES                   | -                    |
|                      | 30 | 14 | 10 | 10                                      | 21,2               | 106                      | 0,050 | GE 17 ES-2RS               | -                    |
| 20                   | 35 | 16 | 12 | 9                                       | 30                 | 146                      | 0,065 | GE 20 ES                   | -                    |
|                      | 35 | 16 | 12 | 9                                       | 30                 | 146                      | 0,065 | GE 20 ES-2RS               | -2LS                 |
|                      | 42 | 25 | 16 | 17                                      | 48                 | 240                      | 0,16  | GEH 20 ES-2RS              | -2LS                 |
| 25                   | 42 | 20 | 16 | 7                                       | 48                 | 240                      | 0,12  | GE 25 ES                   | -                    |
|                      | 42 | 20 | 16 | 7                                       | 48                 | 240                      | 0,12  | GE 25 ES-2RS               | -2LS                 |
|                      | 47 | 28 | 18 | 17                                      | 62                 | 310                      | 0,20  | GEH 25 ES-2RS              | -2LS                 |
| 30                   | 47 | 22 | 18 | 6                                       | 62                 | 310                      | 0,16  | GE 30 ES                   | -                    |
|                      | 47 | 22 | 18 | 6                                       | 62                 | 310                      | 0,16  | GE 30 ES-2RS               | -2LS                 |
|                      | 55 | 32 | 20 | 17                                      | 80                 | 400                      | 0,35  | GEH 30 ES-2RS              | -2LS                 |
| 35                   | 55 | 25 | 20 | 6                                       | 80                 | 400                      | 0,23  | GE 35 ES                   | -                    |
|                      | 55 | 25 | 20 | 6                                       | 80                 | 400                      | 0,23  | GE 35 ES-2RS               | -2LS                 |
|                      | 62 | 35 | 22 | 15                                      | 100                | 500                      | 0,47  | GEH 35 ES-2RS              | -2LS                 |
| 40                   | 62 | 28 | 22 | 7                                       | 100                | 500                      | 0,32  | GE 40 ES                   | -                    |
|                      | 62 | 28 | 22 | 6                                       | 100                | 500                      | 0,32  | GE 40 ES-2RS               | -2LS                 |
|                      | 68 | 40 | 25 | 17                                      | 127                | 640                      | 0,61  | GEH 40 ES-2RS              | -2LS                 |

<sup>1)</sup> To fully utilize the angle of tilt, the shaft shoulder should not be made larger than  $d_{a \max}$ .

<sup>2)</sup> Bearings with an outside diameter  $D \geq 150$  mm have the multi-groove system in the outer ring as standard. Bearings with an outside diameter  $D < 150$  mm can be supplied with the multi-groove system on request (designation suffix ESL).

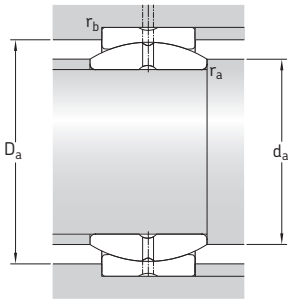

## Dimensions

## Abutment and fillet dimensions

| d  | d <sub>k</sub> | b   | b <sub>1</sub> | M   | r <sub>1</sub><br>min | r <sub>2</sub><br>min | d <sub>a</sub><br>min | d <sub>a</sub><br>max | D <sub>a</sub><br>min | D <sub>a</sub><br>max | r <sub>a</sub><br>max | r <sub>b</sub><br>max |
|----|----------------|-----|----------------|-----|-----------------------|-----------------------|-----------------------|-----------------------|-----------------------|-----------------------|-----------------------|-----------------------|
| mm |                |     |                |     |                       |                       | mm                    |                       |                       |                       |                       |                       |
| 4  | 8              | –   | –              | –   | 0,3                   | 0,3                   | 5,5                   | 6,2                   | 7,6                   | 10,7                  | 0,3                   | 0,3                   |
| 5  | 10             | –   | –              | –   | 0,3                   | 0,3                   | 6,6                   | 8                     | 9,5                   | 12,6                  | 0,3                   | 0,3                   |
| 6  | 10             | –   | –              | –   | 0,3                   | 0,3                   | 7,5                   | 8                     | 9,5                   | 12,6                  | 0,3                   | 0,3                   |
| 8  | 13             | –   | –              | –   | 0,3                   | 0,3                   | 9,6                   | 10,2                  | 12,3                  | 14,5                  | 0,3                   | 0,3                   |
| 10 | 16             | –   | –              | –   | 0,3                   | 0,3                   | 11,7                  | 13,2                  | 17,5                  | 15,2                  | 0,3                   | 0,3                   |
| 12 | 18             | –   | –              | –   | 0,3                   | 0,3                   | 13,8                  | 15                    | 17,1                  | 20,4                  | 0,3                   | 0,3                   |
| 15 | 22             | 2,3 | 2,3            | 1,5 | 0,3                   | 0,3                   | 16,9                  | 18,4                  | 20,9                  | 24,3                  | 0,3                   | 0,3                   |
|    | 22             | 2,3 | 2,3            | 1,5 | 0,3                   | 0,3                   | 16,9                  | 18,4                  | 22,8                  | 24,3                  | 0,3                   | 0,3                   |
| 17 | 25             | 2,3 | 2,3            | 1,5 | 0,3                   | 0,3                   | 19                    | 20,7                  | 23,7                  | 28,3                  | 0,3                   | 0,3                   |
|    | 25             | 2,3 | 2,3            | 1,5 | 0,3                   | 0,3                   | 19                    | 20,7                  | 26                    | 28,3                  | 0,3                   | 0,3                   |
| 20 | 29             | 3,1 | 3,1            | 2   | 0,3                   | 0,3                   | 22,1                  | 24,2                  | 27,6                  | 33,2                  | 0,3                   | 0,3                   |
|    | 29             | 3,1 | 3,1            | 2   | 0,3                   | 0,3                   | 22,1                  | 24,2                  | 30,9                  | 33,2                  | 0,3                   | 0,3                   |
|    | 35,5           | 3,1 | 3,1            | 2   | 0,3                   | 0,6                   | 22,7                  | 25,2                  | 36,9                  | 39,2                  | 0,3                   | 0,6                   |
| 25 | 35,5           | 3,1 | 3,1            | 2   | 0,6                   | 0,6                   | 28,2                  | 29,3                  | 33,7                  | 39,2                  | 0,6                   | 0,6                   |
|    | 35,5           | 3,1 | 3,1            | 2   | 0,6                   | 0,6                   | 28,2                  | 29,3                  | 36,9                  | 39,2                  | 0,6                   | 0,6                   |
|    | 40,7           | 3,1 | 3,1            | 2   | 0,6                   | 0,6                   | 28,6                  | 29,5                  | 41,3                  | 44                    | 0,6                   | 0,6                   |
| 30 | 40,7           | 3,1 | 3,1            | 2   | 0,6                   | 0,6                   | 33,3                  | 34,2                  | 38,7                  | 44                    | 0,6                   | 0,6                   |
|    | 40,7           | 3,1 | 3,1            | 2   | 0,6                   | 0,6                   | 33,3                  | 34,2                  | 41,3                  | 44                    | 0,6                   | 0,6                   |
|    | 47             | 3,9 | 3,9            | 2,5 | 0,6                   | 1                     | 33,7                  | 34,4                  | 48,5                  | 50,9                  | 0,6                   | 1                     |
| 35 | 47             | 3,9 | 3,9            | 2,5 | 0,6                   | 1                     | 38,5                  | 39,8                  | 44,6                  | 50,9                  | 0,6                   | 1                     |
|    | 47             | 3,9 | 3,9            | 2,5 | 0,6                   | 1                     | 38,5                  | 39,8                  | 48,5                  | 50,9                  | 0,6                   | 1                     |
|    | 53             | 3,9 | 3,9            | 2,5 | 0,6                   | 1                     | 38,8                  | 39,8                  | 54,5                  | 57,8                  | 0,6                   | 1                     |
| 40 | 53             | 3,9 | 3,9            | 2,5 | 0,6                   | 1                     | 43,6                  | 45                    | 50,3                  | 57,8                  | 0,6                   | 1                     |
|    | 53             | 3,9 | 3,9            | 2,5 | 0,6                   | 1                     | 43,6                  | 45                    | 54,5                  | 57,8                  | 0,6                   | 1                     |
|    | 60             | 4,6 | 4,6            | 3   | 0,6                   | 1                     | 44,1                  | 44,7                  | 61                    | 63,6                  | 0,6                   | 1                     |

Radial spherical plain bearings, steel/steel, metric sizes  
d 45 – 120 mm

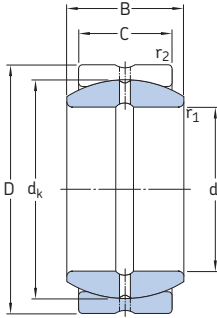

GE .. ES

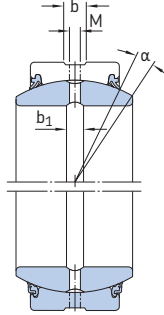

GE .. ES-2RS  
GE .. ES-2LS

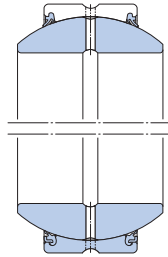

GEH .. ES-2RS  
GEH .. ES-2LS

| Principal dimensions |     |     |    | Angle of tilt <sup>1)</sup><br>$\alpha$ | Basic load ratings |        | Mass | Designations <sup>2)</sup> |                     |
|----------------------|-----|-----|----|---|--------------------|--------|------|----------------------------|---------------------|
| d                    | D   | B   | C  |   | dynamic            | static |      | without seals              | with standard seals |
| mm                   |     |     |    | degrees                                 | kN                 |        | kg   | -                          |                     |
| 45                   | 68  | 32  | 25 | 7                                       | 127                | 640    | 0,46 | GE 45 ES                   | -                   |
|                      | 68  | 32  | 25 | 7                                       | 127                | 640    | 0,46 | GE 45 ES-2RS               | -2LS                |
|                      | 75  | 43  | 28 | 14                                      | 156                | 780    | 0,80 | GEH 45 ES-2RS              | -2LS                |
| 50                   | 75  | 35  | 28 | 6                                       | 156                | 780    | 0,56 | GE 50 ES                   | -                   |
|                      | 75  | 35  | 28 | 6                                       | 156                | 780    | 0,56 | GE 50 ES-2RS               | -2LS                |
|                      | 90  | 56  | 36 | 17                                      | 245                | 1 220  | 1,60 | GEH 50 ES-2RS              | -2LS                |
| 60                   | 90  | 44  | 36 | 6                                       | 245                | 1 220  | 1,10 | GE 60 ES                   | -                   |
|                      | 90  | 44  | 36 | 6                                       | 245                | 1 220  | 1,10 | GE 60 ES-2RS               | -2LS                |
|                      | 105 | 63  | 40 | 17                                      | 315                | 1 560  | 2,40 | GEH 60 ES-2RS              | -2LS                |
| 70                   | 105 | 49  | 40 | 6                                       | 315                | 1 560  | 1,55 | GE 70 ES                   | -                   |
|                      | 105 | 49  | 40 | 6                                       | 315                | 1 560  | 1,55 | GE 70 ES-2RS               | -2LS                |
|                      | 120 | 70  | 45 | 16                                      | 400                | 2 000  | 3,40 | GEH 70 ES-2RS              | -2LS                |
| 80                   | 120 | 55  | 45 | 6                                       | 400                | 2 000  | 2,30 | GE 80 ES                   | -                   |
|                      | 120 | 55  | 45 | 5                                       | 400                | 2 000  | 2,30 | GE 80 ES-2RS               | -2LS                |
|                      | 130 | 75  | 50 | 14                                      | 490                | 2 450  | 4,10 | GEH 80 ES-2RS              | -2LS                |
| 90                   | 130 | 60  | 50 | 5                                       | 490                | 2 450  | 2,75 | GE 90 ES                   | -                   |
|                      | 130 | 60  | 50 | 5                                       | 490                | 2 450  | 2,75 | GE 90 ES-2RS               | -2LS                |
|                      | 150 | 85  | 55 | 15                                      | 610                | 3 050  | 6,30 | GEH 90 ES-2RS              | -2LS                |
| 100                  | 150 | 70  | 55 | 7                                       | 610                | 3 050  | 4,40 | GE 100 ES                  | -                   |
|                      | 150 | 70  | 55 | 6                                       | 610                | 3 050  | 4,40 | GE 100 ES-2RS              | -2LS                |
|                      | 160 | 85  | 55 | 13                                      | 655                | 3 250  | 6,80 | GEH 100 ES-2RS             | -2LS                |
| 110                  | 160 | 70  | 55 | 6                                       | 655                | 3 250  | 4,80 | GE 110 ES                  | -                   |
|                      | 160 | 70  | 55 | 6                                       | 655                | 3 250  | 4,80 | GE 110 ES-2RS              | -2LS                |
|                      | 180 | 100 | 70 | 12                                      | 950                | 4 750  | 11,0 | GEH 110 ES-2RS             | -2LS                |
| 120                  | 180 | 85  | 70 | 6                                       | 950                | 4 750  | 8,25 | GE 120 ES                  | -                   |
|                      | 180 | 85  | 70 | 6                                       | 950                | 4 750  | 8,25 | GE 120 ES-2RS              | -2LS                |
|                      | 210 | 115 | 70 | 16                                      | 1 080              | 5 400  | 15,0 | GEH 120 ES-2RS             | -2LS                |

<sup>1)</sup> To fully utilize the angle of tilt, the shaft shoulder should not be made larger than  $d_{a \max}$ .

<sup>2)</sup> Bearings with an outside diameter  $D \geq 150$  mm have the multi-groove system in the outer ring as standard. Bearings with an outside diameter  $D < 150$  mm can be supplied with the multi-groove system on request (designation suffix ESL).

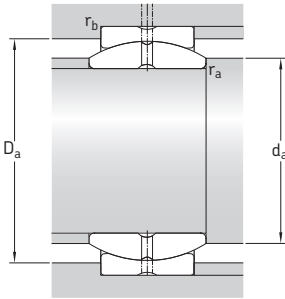

## Dimensions

## Abutment and fillet dimensions

| d   | d <sub>k</sub> | b    | b <sub>1</sub> | M | r <sub>1</sub><br>min | r <sub>2</sub><br>min | d <sub>a</sub><br>min | d <sub>a</sub><br>max | D <sub>a</sub><br>min | D <sub>a</sub><br>max | r <sub>a</sub><br>max | r <sub>b</sub><br>max |
|-----|----------------|------|----------------|---|-----------------------|-----------------------|-----------------------|-----------------------|-----------------------|-----------------------|-----------------------|-----------------------|
| mm  |                |      |                |   |                       |                       | mm                    |                       |                       |                       |                       |                       |
| 45  | 60             | 4,6  | 4,6            | 3 | 0,6                   | 1                     | 49,4                  | 50,8                  | 57                    | 63,6                  | 0,6                   | 1                     |
|     | 60             | 4,6  | 4,6            | 3 | 0,6                   | 1                     | 49,4                  | 50,8                  | 61                    | 63,6                  | 0,6                   | 1                     |
|     | 66             | 4,6  | 4,6            | 3 | 0,6                   | 1                     | 49,8                  | 50,1                  | 66,2                  | 70,5                  | 0,6                   | 1                     |
| 50  | 66             | 4,6  | 4,6            | 3 | 0,6                   | 1                     | 54,6                  | 56                    | 62,7                  | 70,5                  | 0,6                   | 1                     |
|     | 66             | 4,6  | 4,6            | 3 | 0,6                   | 1                     | 54,6                  | 56                    | 66,2                  | 70,5                  | 0,6                   | 1                     |
|     | 80             | 6,2  | 6,2            | 4 | 0,6                   | 1                     | 55,8                  | 57,1                  | 79,7                  | 84,2                  | 0,6                   | 1                     |
| 60  | 80             | 6,2  | 6,2            | 4 | 1                     | 1                     | 66,4                  | 66,8                  | 76                    | 84,2                  | 1                     | 1                     |
|     | 80             | 6,2  | 6,2            | 4 | 1                     | 1                     | 66,4                  | 66,8                  | 79,7                  | 84,2                  | 1                     | 1                     |
|     | 92             | 7,7  | 7,7            | 4 | 1                     | 1                     | 67                    | 67                    | 92                    | 99                    | 1                     | 1                     |
| 70  | 92             | 7,7  | 7,7            | 4 | 1                     | 1                     | 76,7                  | 77,9                  | 87,4                  | 99                    | 1                     | 1                     |
|     | 92             | 7,7  | 7,7            | 4 | 1                     | 1                     | 76,7                  | 77,9                  | 92                    | 99                    | 1                     | 1                     |
|     | 105            | 7,7  | 7,7            | 4 | 1                     | 1                     | 77,5                  | 78,3                  | 104,4                 | 113,8                 | 1                     | 1                     |
| 80  | 105            | 7,7  | 7,7            | 4 | 1                     | 1                     | 87,1                  | 89,4                  | 99,7                  | 113,8                 | 1                     | 1                     |
|     | 105            | 7,7  | 7,7            | 4 | 1                     | 1                     | 87,1                  | 89,4                  | 104,4                 | 113,8                 | 1                     | 1                     |
|     | 115            | 9,5  | 9,5            | 5 | 1                     | 1                     | 87,2                  | 87,2                  | 112,9                 | 123,5                 | 1                     | 1                     |
| 90  | 115            | 9,5  | 9,5            | 5 | 1                     | 1                     | 97,4                  | 98,1                  | 109,3                 | 123,5                 | 1                     | 1                     |
|     | 115            | 9,5  | 9,5            | 5 | 1                     | 1                     | 97,4                  | 98,1                  | 112,9                 | 123,5                 | 1                     | 1                     |
|     | 130            | 11,3 | 11,3           | 5 | 1                     | 1                     | 98,2                  | 98,4                  | 131                   | 143,2                 | 1                     | 1                     |
| 100 | 130            | 11,3 | 11,3           | 5 | 1                     | 1                     | 107,8                 | 109,5                 | 123,5                 | 143,2                 | 1                     | 1                     |
|     | 130            | 11,3 | 11,3           | 5 | 1                     | 1                     | 107,8                 | 109,5                 | 131                   | 143,2                 | 1                     | 1                     |
|     | 140            | 11,5 | 11,5           | 5 | 1                     | 1                     | 108,1                 | 111,2                 | 141,5                 | 153,3                 | 1                     | 1                     |
| 110 | 140            | 11,5 | 11,5           | 5 | 1                     | 1                     | 118                   | 121                   | 133                   | 153                   | 1                     | 1                     |
|     | 140            | 11,5 | 11,5           | 5 | 1                     | 1                     | 118                   | 121                   | 141,5                 | 153                   | 1                     | 1                     |
|     | 160            | 13,5 | 13,5           | 6 | 1                     | 1                     | 119,5                 | 124,5                 | 157,5                 | 172                   | 1                     | 1                     |
| 120 | 160            | 13,5 | 13,5           | 6 | 1                     | 1                     | 129,5                 | 135,5                 | 152                   | 172                   | 1                     | 1                     |
|     | 160            | 13,5 | 13,5           | 6 | 1                     | 1                     | 129,5                 | 135,5                 | 157,5                 | 172                   | 1                     | 1                     |
|     | 180            | 13,5 | 13,5           | 6 | 1                     | 1                     | 130                   | 138,5                 | 180                   | 202,5                 | 1                     | 1                     |

Radial spherical plain bearings, steel/steel, metric sizes  
d 140 – 300 mm

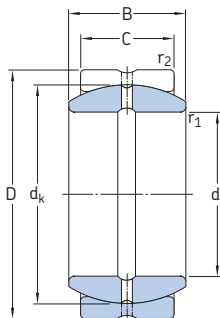

GE .. ES

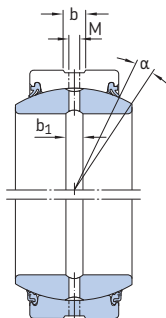

GE .. ES-2RS  
GE .. ES-2LS

| Principal dimensions |     |     |     | Angle of tilt <sup>1)</sup><br>$\alpha$ | Basic load ratings |        | Mass | Designations <sup>2)</sup> |                     |
|----------------------|-----|-----|-----|---|--------------------|--------|------|----------------------------|---------------------|
| d                    | D   | B   | C   |   | dynamic            | static |      | without seals              | with standard seals |
| mm                   |     |     |     | degrees                                 | kN                 |        | kg   | -                          |                     |
| <b>140</b>           | 210 | 90  | 70  | 7                                       | 1 080              | 5 400  | 11,0 | <b>GE 140 ES</b>           | -                   |
|                      | 210 | 90  | 70  | 7                                       | 1 080              | 5 400  | 11,0 | <b>GE 140 ES-2RS</b>       | -2LS                |
| <b>160</b>           | 230 | 105 | 80  | 8                                       | 1 370              | 6 800  | 14,0 | <b>GE 160 ES</b>           | -                   |
|                      | 230 | 105 | 80  | 8                                       | 1 370              | 6 800  | 14,0 | <b>GE 160 ES-2RS</b>       | -2LS                |
| <b>180</b>           | 260 | 105 | 80  | 6                                       | 1 530              | 7 650  | 18,5 | <b>GE 180 ES</b>           | -                   |
|                      | 260 | 105 | 80  | 6                                       | 1 530              | 7 650  | 18,5 | <b>GE 180 ES-2RS</b>       | -2LS                |
| <b>200</b>           | 290 | 130 | 100 | 7                                       | 2 120              | 10 600 | 28,0 | <b>GE 200 ES</b>           | -                   |
|                      | 290 | 130 | 100 | 7                                       | 2 120              | 10 600 | 28,0 | <b>GE 200 ES-2RS</b>       | -2LS                |
| <b>220</b>           | 320 | 135 | 100 | 8                                       | 2 320              | 11 600 | 35,5 | <b>GE 220 ES-2RS</b>       | -2LS                |
| <b>240</b>           | 340 | 140 | 100 | 8                                       | 2 550              | 12 700 | 40,0 | <b>GE 240 ES-2RS</b>       | -2LS                |
| <b>260</b>           | 370 | 150 | 110 | 7                                       | 3 050              | 15 300 | 51,5 | <b>GE 260 ES-2RS</b>       | -2LS                |
| <b>280</b>           | 400 | 155 | 120 | 6                                       | 3 550              | 18 000 | 65,0 | <b>GE 280 ES-2RS</b>       | -2LS                |
| <b>300</b>           | 430 | 165 | 120 | 7                                       | 3 800              | 19 000 | 78,5 | <b>GE 300 ES-2RS</b>       | -2LS                |

<sup>1)</sup> To fully utilize the angle of tilt, the shaft shoulder should not be made larger than  $d_a \text{ max.}$

<sup>2)</sup> Bearings with an outside diameter  $D \geq 150$  mm have the multi-groove system in the outer ring as standard.

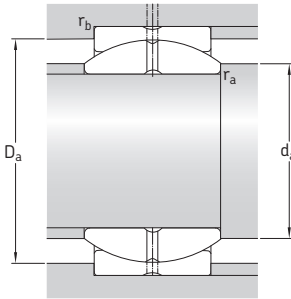

## Dimensions

## Abutment and fillet dimensions

| d          | d <sub>k</sub> | b    | b <sub>1</sub> | M | r <sub>1</sub><br>min | r <sub>2</sub><br>min | d <sub>a</sub><br>min | d <sub>a</sub><br>max | D <sub>a</sub><br>min | D <sub>a</sub><br>max | r <sub>a</sub><br>max | r <sub>b</sub><br>max |
|------------|----------------|------|----------------|---|-----------------------|-----------------------|-----------------------|-----------------------|-----------------------|-----------------------|-----------------------|-----------------------|
| mm         |                |      |                |   |                       |                       | mm                    |                       |                       |                       |                       |                       |
| <b>140</b> | 180            | 13,5 | 13,5           | 6 | 1                     | 1                     | 149                   | 155,5                 | 171                   | 202,5                 | 1                     | 1                     |
|            | 180            | 13,5 | 13,5           | 6 | 1                     | 1                     | 149                   | 155,5                 | 180                   | 202,5                 | 1                     | 1                     |
| <b>160</b> | 200            | 13,5 | 13,5           | 6 | 1                     | 1                     | 169,5                 | 170                   | 190                   | 222                   | 1                     | 1                     |
|            | 200            | 13,5 | 13,5           | 6 | 1                     | 1                     | 169,5                 | 170                   | 197                   | 222                   | 1                     | 1                     |
| <b>180</b> | 225            | 13,5 | 13,5           | 6 | 1,1                   | 1,1                   | 191                   | 199                   | 214                   | 250,5                 | 1                     | 1                     |
|            | 225            | 13,5 | 13,5           | 6 | 1,1                   | 1,1                   | 191                   | 199                   | 224,5                 | 250,5                 | 1                     | 1                     |
| <b>200</b> | 250            | 15,5 | 15,5           | 7 | 1,1                   | 1,1                   | 212,5                 | 213,5                 | 237,5                 | 279,5                 | 1                     | 1                     |
|            | 250            | 15,5 | 15,5           | 7 | 1,1                   | 1,1                   | 212,5                 | 213,5                 | 244,5                 | 279,5                 | 1                     | 1                     |
| <b>220</b> | 275            | 15,5 | 15,5           | 7 | 1,1                   | 1,1                   | 232,5                 | 239,5                 | 271                   | 309,5                 | 1                     | 1                     |
| <b>240</b> | 300            | 15,5 | 15,5           | 7 | 1,1                   | 1,1                   | 252,5                 | 265                   | 298                   | 329,5                 | 1                     | 1                     |
| <b>260</b> | 325            | 15,5 | 15,5           | 7 | 1,1                   | 1,1                   | 273                   | 288                   | 321,5                 | 359                   | 1                     | 1                     |
| <b>280</b> | 350            | 15,5 | 15,5           | 7 | 1,1                   | 1,1                   | 294                   | 313,5                 | 344,5                 | 388,5                 | 1                     | 1                     |
| <b>300</b> | 375            | 15,5 | 15,5           | 7 | 1,1                   | 1,1                   | 314                   | 336,5                 | 371                   | 418,5                 | 1                     | 1                     |

**Radial spherical plain bearings, steel/steel, inch sizes  
d 0.5 – 2 in**

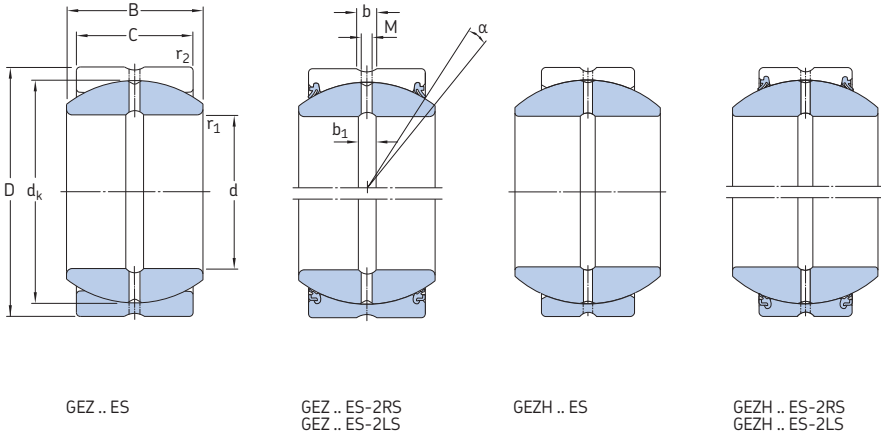

| Principal dimensions   |                  |                  |                | Angle of tilt <sup>1)</sup><br>$\alpha$ | Basic load ratings |                          | Mass           | Designations       |   |
|------------------------|------------------|------------------|----------------|---|--------------------|--------------------------|----------------|--------------------|---|
| d                      | D                | B                | C              |   | dynamic<br>C       | static<br>C <sub>0</sub> |                | without seals      | suffix for seal variants<br>standard heavy-duty |
| in/mm                  |                  |                  |                | degrees                                 | lbf/kN             |                          | lb/kg          | –                  |   |
| <b>0.5</b><br>12,700   | 0.8750<br>22,225 | 0.437<br>11,10   | 0.375<br>9,53  | 6                                       | 3 150<br>14        | 9 340<br>41,5            | 0.044<br>0,020 | <b>GEZ 008 ES</b>  | – –   |
| <b>0.625</b><br>15,875 | 1.0625<br>26,988 | 0.547<br>13,89   | 0.469<br>11,91 | 6                                       | 4 840<br>21,5      | 14 740<br>65,5           | 0.077<br>0,035 | <b>GEZ 010 ES</b>  | – –   |
| <b>0.75</b><br>19,050  | 1.2500<br>31,750 | 0.656<br>16,66   | 0.562<br>14,28 | 6                                       | 7 090<br>31,5      | 20 930<br>93             | 0.12<br>0,055  | <b>GEZ 012 ES</b>  | -2RS –  |
| <b>0.875</b><br>22,225 | 1.4375<br>36,513 | 0.765<br>19,43   | 0.656<br>16,66 | 6                                       | 9 560<br>42,5      | 28 580<br>127            | 0.19<br>0,085  | <b>GEZ 014 ES</b>  | – –   |
| <b>1</b><br>25,400     | 1.6250<br>41,275 | 0.875<br>22,23   | 0.750<br>19,05 | 6                                       | 12 600<br>56       | 37 350<br>166            | 0.26<br>0,12   | <b>GEZ 100 ES</b>  | -2RS -2LS                                       |
| <b>1.25</b><br>31,750  | 2.0000<br>50,800 | 1.093<br>27,76   | 0.937<br>23,80 | 6                                       | 19 460<br>86,5     | 58 500<br>260            | 0.51<br>0,23   | <b>GEZ 104 ES</b>  | -2RS -2LS                                       |
|                        |                  | 2.4375<br>61,913 | 1.390<br>35,31 | 8                                       | 28 125<br>125      | 84 375<br>375            | 1.20<br>0,54   | <b>GEZH 104 ES</b> | -2RS -2LS                                       |
| <b>1.375</b><br>34,925 | 2.1875<br>55,563 | 1.187<br>30,15   | 1.031<br>26,19 | 6                                       | 23 400<br>104      | 69 750<br>310            | 0.77<br>0,35   | <b>GEZ 106 ES</b>  | -2RS -2LS                                       |
| <b>1.5</b><br>38,100   | 2.4375<br>61,913 | 1.312<br>33,33   | 1.125<br>28,58 | 6                                       | 28 130<br>125      | 84 380<br>375            | 0.93<br>0,42   | <b>GEZ 108 ES</b>  | -2RS -2LS                                       |
|                        |                  | 2.8125<br>71,438 | 1.580<br>40,13 | 7                                       | 38 250<br>170      | 114 750<br>510           | 1.75<br>0,79   | <b>GEZH 108 ES</b> | -2RS -2LS                                       |
| <b>1.75</b><br>44,450  | 2.8125<br>71,438 | 1.531<br>38,89   | 1.312<br>33,33 | 6                                       | 38 250<br>170      | 114 750<br>510           | 1.40<br>0,64   | <b>GEZ 112 ES</b>  | -2RS -2LS                                       |
|                        |                  | 3.1875<br>80,963 | 1.820<br>46,23 | 7                                       | 50 400<br>224      | 150 750<br>670           | 2.50<br>1,13   | <b>GEZH 112 ES</b> | -2RS -2LS                                       |
| <b>2</b><br>50,800     | 3.1875<br>80,963 | 1.750<br>44,45   | 1.500<br>38,10 | 6                                       | 50 400<br>224      | 150 750<br>670           | 2.05<br>0,93   | <b>GEZ 200 ES</b>  | -2RS -2LS                                       |
|                        |                  | 3.5625<br>90,488 | 2.070<br>52,58 | 8                                       | 63 000<br>280      | 191 250<br>850           | 3.50<br>1,60   | <b>GEZH 200 ES</b> | -2RS -2LS                                       |

<sup>1)</sup> To fully utilize the angle of tilt, the shaft shoulder should not be larger than  $d_{a \max}$ .



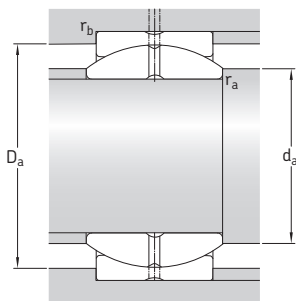

## Dimensions

## Abutment and fillet dimensions

| d                      | d <sub>k</sub>   | b            | b <sub>1</sub> | M            | r <sub>1</sub> <sup>1)</sup><br>min | r <sub>2</sub> <sup>2)</sup><br>min | d <sub>a</sub><br>min | d <sub>a</sub><br>max | D <sub>a</sub><br>min | D <sub>a</sub> sealed<br>min | D <sub>a</sub><br>max | r <sub>a</sub><br>max | r <sub>b</sub><br>max |
|------------------------|------------------|--------------|----------------|--------------|-------------------------------------|-------------------------------------|-----------------------|-----------------------|-----------------------|------------------------------|-----------------------|-----------------------|-----------------------|
| in/mm                  |                  |              |                |              |                                     |                                     | in/mm                 |                       |                       |                              |                       |                       |                       |
| <b>0.5</b><br>12,700   | 0.7190<br>18,263 | 0.102<br>2,6 | 0.098<br>2,5   | 0.059<br>1,5 | 0.006<br>0,2                        | 0.024<br>0,6                        | 0.54<br>13,7          | 0.57<br>14,5          | 0.68<br>17,3          | –                            | 0.78<br>19,9          | 0.006<br>0,2          | 0.024<br>0,6          |
| <b>0.625</b><br>15,875 | 0.8990<br>22,835 | 0.126<br>3,2 | 0.118<br>3     | 0.098<br>2,5 | 0.006<br>0,2                        | 0.039<br>1                          | 0.67<br>17            | 0.71<br>18,1          | 0.85<br>21,7          | –                            | 0.93<br>23,6          | 0.006<br>0,2          | 0.039<br>1            |
| <b>0.75</b><br>19,050  | 1.0800<br>27,432 | 0.126<br>3,2 | 0.118<br>3     | 0.098<br>2,5 | 0.012<br>0,3                        | 0.039<br>1                          | 0.82<br>20,9          | 0.86<br>21,8          | 1.03<br>26,1          | 1.1<br>27,9                  | 1.11<br>28,3          | 0.012<br>0,3          | 0.039<br>1            |
| <b>0.875</b><br>22,225 | 1.2580<br>31,953 | 0.126<br>3,2 | 0.118<br>3     | 0.098<br>2,5 | 0.012<br>0,3                        | 0.039<br>1                          | 0.95<br>24,2          | 1<br>25,4             | 1.2<br>30,4           | –                            | 1.3<br>33             | 0.012<br>0,3          | 0.039<br>1            |
| <b>1</b><br>25,400     | 1.4370<br>36,500 | 0.126<br>3,2 | 0.118<br>3     | 0.098<br>2,5 | 0.012<br>0,3                        | 0.039<br>1                          | 1.08<br>27,5          | 1.14<br>29            | 1.37<br>34,7          | 1.39<br>35,2                 | 1.48<br>37,7          | 0.012<br>0,3          | 0.039<br>1            |
| <b>1.25</b><br>31,750  | 1.7950<br>45,593 | 0.189<br>4,8 | 0.197<br>5     | 0.157<br>4   | 0.024<br>0,6                        | 0.039<br>1                          | 1.37<br>34,8          | 1.43<br>36,2          | 1.7<br>43,3           | 1.76<br>44,8                 | 1.85<br>47            | 0.024<br>0,6          | 0.039<br>1            |
|                        | 2.1550<br>54,737 | 0.189<br>4,8 | 0.197<br>5     | 0.157<br>4   | 0.039<br>1                          | 0.039<br>1                          | 1.43<br>36,2          | 1.65<br>41,8          | 2.05<br>52            | 2.06<br>52,3                 | 2.28<br>58            | 0.039<br>1            | 0.039<br>1            |
| <b>1.375</b><br>34,925 | 1.9370<br>49,200 | 0.189<br>4,8 | 0.197<br>5     | 0.157<br>4   | 0.024<br>0,6                        | 0.039<br>1                          | 1.5<br>38,1           | 1.53<br>38,9          | 1.84<br>46,7          | 1.85<br>47,1                 | 2.035<br>51,7         | 0.024<br>0,6          | 0.039<br>1            |
| <b>1.5</b><br>38,100   | 2.1550<br>54,737 | 0.189<br>4,8 | 0.197<br>5     | 0.157<br>4   | 0.024<br>0,6                        | 0.039<br>1                          | 1.63<br>41,4          | 1.71<br>43,4          | 2.05<br>52            | 2.06<br>52,3                 | 2.28<br>58            | 0.024<br>0,6          | 0.039<br>1            |
|                        | 2.5150<br>63,881 | 0.189<br>4,8 | 0.197<br>5     | 0.157<br>4   | 0.039<br>1                          | 0.039<br>1                          | 1.69<br>42,8          | 1.96<br>49,7          | 2.39<br>60,7          | 2.41<br>61,3                 | 2.65<br>67,4          | 0.039<br>1            | 0.039<br>1            |
| <b>1.75</b><br>44,450  | 2.5150<br>63,881 | 0.189<br>4,8 | 0.197<br>5     | 0.157<br>4   | 0.024<br>0,6                        | 0.039<br>1                          | 1.91<br>48,5          | 2<br>50,7             | 2.39<br>60,7          | 2.41<br>61,3                 | 2.65<br>67,4          | 0.024<br>0,6          | 0.039<br>1            |
|                        | 2.8750<br>73,025 | 0.189<br>4,8 | 0.197<br>5     | 0.157<br>4   | 0.059<br>1,5                        | 0.039<br>1                          | 2.00<br>50,9          | 2.22<br>56,5          | 2.73<br>69,4          | 2.85<br>72,4                 | 2.99<br>75,9          | 0.059<br>1,5          | 0.039<br>1            |
| <b>2</b><br>50,800     | 2.8750<br>73,025 | 0.189<br>4,8 | 0.197<br>5     | 0.157<br>4   | 0.024<br>0,6                        | 0.039<br>1                          | 2.17<br>55,1          | 2.28<br>57,9          | 2.73<br>69,4          | 2.85<br>72,4                 | 2.99<br>75,9          | 0.024<br>0,6          | 0.039<br>1            |
|                        | 3.2350<br>82,169 | 0.224<br>5,7 | 0.197<br>5     | 0.157<br>4   | 0.059<br>1,5                        | 0.039<br>1                          | 2.26<br>57,5          | 2.48<br>63,1          | 3.07<br>78,1          | 3.11<br>79                   | 3.36<br>85,3          | 0.059<br>1,5          | 0.039<br>1            |

<sup>1)</sup> Equal to maximum shaft fillet radius  $r_{a \max}$ .

<sup>2)</sup> Equal to maximum housing fillet radius  $r_{b \max}$ .

**Radial spherical plain bearings, steel/steel, inch sizes**  
**d 2.25 – 4 in**

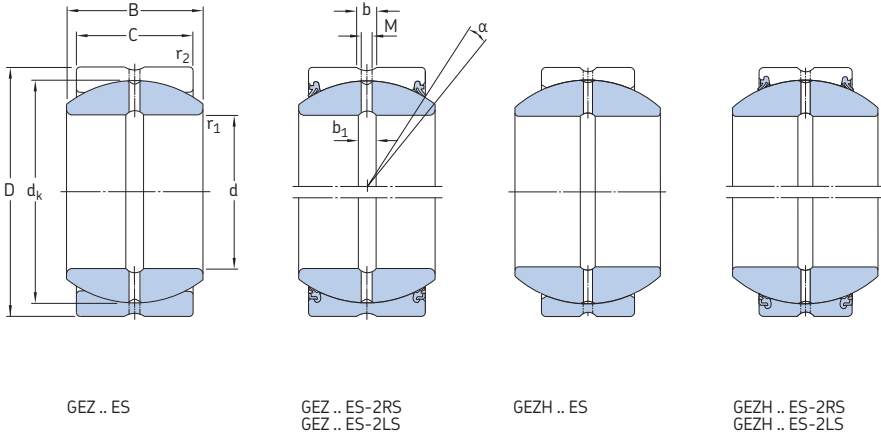

| Principal dimensions  |         |        |       | Angle of tilt <sup>1)</sup> | Basic load ratings |                | Mass  | Designations  |                          |      |
|-----------------------|---------|--------|-------|-----------------------------|--------------------|----------------|-------|---------------|--------------------------|------|
| d                     | D       | B      | C     | $\alpha$                    | C                  | C <sub>0</sub> |       | without seals | suffix for seal variants |      |
| in/mm                 |         |        |       | degrees                     | lbf/kN             |                | lb/kg | -             |                          |      |
| <b>2.25</b><br>57,150 | 3.5625  | 1.969  | 1.687 | 6                           | 63 000             | 191 250        | 2.85  | GEZ 204 ES    | -2RS                     | -2LS |
|                       | 90,488  | 50,01  | 42,85 | 8                           | 280                | 850            | 1,30  | GEZH 204 ES   | -2RS                     | -2LS |
|                       | 3.9375  | 2.318  | 1.875 |                             | 77 625             | 234 000        | 4.65  |               |                          |      |
|                       | 100,013 | 58,88  | 47,63 |                             | 345                | 1 040          | 2,10  |               |                          |      |
| <b>2.5</b><br>63,500  | 3.9375  | 2.187  | 1.875 | 6                           | 77 630             | 234 000        | 4.10  | GEZ 208 ES    | -2RS                     | -2LS |
|                       | 100,013 | 55,55  | 47,63 | 8                           | 345                | 1 040          | 1,85  | GEZH 208 ES   | -2RS                     | -2LS |
|                       | 4.3750  | 2.545  | 2.062 |                             | 95 625             | 285 750        | 6.30  |               |                          |      |
|                       | 111,125 | 64,64  | 52,38 |                             | 425                | 1 270          | 2,85  |               |                          |      |
| <b>2.75</b><br>69,850 | 4.3750  | 2.406  | 2.062 | 6                           | 95 630             | 285 750        | 5.30  | GEZ 212 ES    | -2RS                     | -2LS |
|                       | 111,125 | 61,11  | 52,38 | 8                           | 425                | 1 270          | 2,40  | GEZH 212 ES   | -2RS                     | -2LS |
|                       | 4.7500  | 2.790  | 2.250 |                             | 112 500            | 337 500        | 8.05  |               |                          |      |
|                       | 120,650 | 70,87  | 57,15 |                             | 500                | 1 500          | 3,65  |               |                          |      |
| <b>3</b><br>76,200    | 4.7500  | 2.625  | 2.250 | 6                           | 112 500            | 337 500        | 6.85  | GEZ 300 ES    | -2RS                     | -2LS |
|                       | 120,650 | 66,68  | 57,15 | 8                           | 500                | 1 500          | 3,10  | GEZH 300 ES   | -2RS                     | -2LS |
|                       | 5.1250  | 3.022  | 2.437 |                             | 131 625            | 396 000        | 10.0  |               |                          |      |
|                       | 130,175 | 76,76  | 61,90 |                             | 585                | 1 760          | 4,55  |               |                          |      |
| <b>3.25</b><br>82,550 | 5.1250  | 2.844  | 2.437 | 6                           | 131 630            | 396 000        | 8.40  | GEZ 304 ES    | -2RS                     | -2LS |
|                       | 130,175 | 72,24  | 61,90 | 9                           | 585                | 1 760          | 3,80  | GEZH 304 ES   | -2RS                     | -2LS |
|                       | 5.5000  | 3.265  | 2.625 |                             | 153 000            | 459 000        | 12.3  |               |                          |      |
|                       | 139,700 | 82,93  | 66,68 |                             | 680                | 2 040          | 5,60  |               |                          |      |
| <b>3.5</b><br>88,900  | 5.5000  | 3.062  | 2.625 | 6                           | 153 000            | 459 000        | 10.5  | GEZ 308 ES    | -2RS                     | -2LS |
|                       | 139,700 | 77,78  | 66,68 | 9                           | 680                | 2 040          | 4,80  | GEZH 308 ES   | -2RS                     | -2LS |
|                       | 5.8750  | 3.560  | 2.812 |                             | 175 500            | 531 000        | 15.0  |               |                          |      |
|                       | 149,225 | 90,42  | 71,43 |                             | 780                | 2 360          | 6,80  |               |                          |      |
| <b>3.75</b><br>95,250 | 5.8750  | 3.281  | 2.812 | 6                           | 175 500            | 531 000        | 13.0  | GEZ 312 ES    | -2RS                     | -2LS |
|                       | 149,225 | 83,34  | 71,43 | 9                           | 780                | 2 360          | 5,80  | GEZH 312 ES   | -2RS                     | -2LS |
|                       | 6.2500  | 3.738  | 3.000 |                             | 202 500            | 596 250        | 17.9  |               |                          |      |
|                       | 158,750 | 94,95  | 76,20 |                             | 900                | 2 650          | 8,10  |               |                          |      |
| <b>4</b><br>101,600   | 6.2500  | 3.500  | 3.000 | 6                           | 202 500            | 596 250        | 15.5  | GEZ 400 ES    | -2RS                     | -2LS |
|                       | 158,750 | 88,90  | 76,20 | 9                           | 900                | 2 650          | 7,00  | GEZH 400 ES   | -2RS                     | -2LS |
|                       | 7.0000  | 4.225  | 3.375 |                             | 252 000            | 765 000        | 30.0  |               |                          |      |
|                       | 177,800 | 107,32 | 85,73 |                             | 1 120              | 3 400          | 13,5  |               |                          |      |

<sup>1)</sup> To fully utilize the angle of tilt, the shaft shoulder should not be larger than  $d_{a \max}$ .

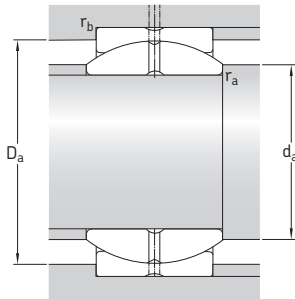

## Dimensions

## Abutment and fillet dimensions

| d                     | d <sub>k</sub> | b     | b <sub>1</sub> | M     | r <sub>1</sub> <sup>1)</sup><br>min | r <sub>2</sub> <sup>2)</sup><br>min | d <sub>a</sub><br>min | d <sub>a</sub><br>max | D <sub>a</sub><br>min | D <sub>a</sub> sealed<br>min | D <sub>a</sub><br>max | r <sub>a</sub><br>max | r <sub>b</sub><br>max |
|-----------------------|----------------|-------|----------------|-------|-------------------------------------|-------------------------------------|-----------------------|-----------------------|-----------------------|------------------------------|-----------------------|-----------------------|-----------------------|
| in/mm                 |                |       |                |       |                                     |                                     | in/mm                 |                       |                       |                              |                       |                       |                       |
| <b>2.25</b><br>57,150 | 3.2350         | 0.224 | 0.197          | 0.157 | 0.024                               | 0.039                               | 2.43                  | 2.57                  | 3.07                  | 3.11                         | 3.36                  | 0.024                 | 0.039                 |
|                       | 82,169         | 5,7   | 5              | 4     | 0,6                                 | 1                                   | 61,7                  | 65,2                  | 78,1                  | 79                           | 85,3                  | 0,6                   | 1                     |
|                       | 3.5900         | 0.354 | 0.315          | 0.256 | 0.059                               | 0.039                               | 2.52                  | 2.74                  | 3.41                  | 3.43                         | 3.73                  | 0.059                 | 0.039                 |
|                       | 91,186         | 9     | 8              | 6,5   | 1,5                                 | 1                                   | 64,1                  | 69,6                  | 86,6                  | 87                           | 94,7                  | 1,5                   | 1                     |
| <b>2.5</b><br>63,500  | 3.5900         | 0.354 | 0.315          | 0.256 | 0.024                               | 0.039                               | 2.69                  | 2.85                  | 3.41                  | 3.43                         | 3.73                  | 0.024                 | 0.039                 |
|                       | 91,186         | 9     | 8              | 6,5   | 0,6                                 | 1                                   | 68,3                  | 72,3                  | 86,6                  | 87                           | 94,7                  | 0,6                   | 1                     |
|                       | 3.9500         | 0.354 | 0.315          | 0.256 | 0.079                               | 0.039                               | 2.84                  | 3.02                  | 3.75                  | 3.78                         | 4.16                  | 0.079                 | 0.039                 |
|                       | 100,330        | 9     | 8              | 6,5   | 2                                   | 1                                   | 72                    | 76,7                  | 95,3                  | 96                           | 105,7                 | 2                     | 1                     |
| <b>2.75</b><br>69,850 | 3.9500         | 0.354 | 0.315          | 0.256 | 0.024                               | 0.039                               | 2.95                  | 3.13                  | 3.75                  | 3.78                         | 4.16                  | 0.024                 | 0.039                 |
|                       | 100,330        | 9     | 8              | 6,5   | 0,6                                 | 1                                   | 74,9                  | 79,6                  | 95,3                  | 96                           | 105,7                 | 0,6                   | 1                     |
|                       | 4.3120         | 0.354 | 0.315          | 0.256 | 0.079                               | 0.039                               | 3.09                  | 3.29                  | 4.09                  | 4.13                         | 4.53                  | 0.079                 | 0.039                 |
|                       | 109,525        | 9     | 8              | 6,5   | 2                                   | 1                                   | 78,6                  | 83,5                  | 104                   | 104,8                        | 115                   | 2                     | 1                     |
| <b>3</b><br>76,200    | 4.3120         | 0.354 | 0.315          | 0.256 | 0.024                               | 0.039                               | 3.2                   | 3.42                  | 4.09                  | 4.13                         | 4.53                  | 0.024                 | 0.039                 |
|                       | 109,525        | 9     | 8              | 6,5   | 0,6                                 | 1                                   | 81,4                  | 86,9                  | 104                   | 104,8                        | 115                   | 0,6                   | 1                     |
|                       | 4.6750         | 0.366 | 0.315          | 0.256 | 0.079                               | 0.039                               | 3.35                  | 3.57                  | 4.44                  | 4.5                          | 4.90                  | 0.079                 | 0.039                 |
|                       | 118,745        | 9,3   | 8              | 6,5   | 2                                   | 1                                   | 85,1                  | 90,6                  | 112,8                 | 114,2                        | 124,4                 | 2                     | 1                     |
| <b>3.25</b><br>82,550 | 4.6750         | 0.366 | 0.315          | 0.256 | 0.024                               | 0.039                               | 3.46                  | 3.71                  | 4.44                  | 4.5                          | 4.9                   | 0.024                 | 0.039                 |
|                       | 118,745        | 9,3   | 8              | 6,5   | 0,6                                 | 1                                   | 88                    | 94,2                  | 112,8                 | 114,2                        | 124,4                 | 0,6                   | 1                     |
|                       | 5.0400         | 0.413 | 0.315          | 0.256 | 0.079                               | 0.039                               | 3.65                  | 3.84                  | 4.79                  | 4.83                         | 5.27                  | 0.079                 | 0.039                 |
|                       | 128,016        | 10,5  | 8              | 6,5   | 2                                   | 1                                   | 92,7                  | 97,5                  | 121,6                 | 122,8                        | 133,8                 | 2                     | 1                     |
| <b>3.5</b><br>88,900  | 5.0400         | 0.413 | 0.315          | 0.256 | 0.024                               | 0.039                               | 3.72                  | 4                     | 4.79                  | 4.83                         | 5.27                  | 0.024                 | 0.039                 |
|                       | 128,016        | 10,5  | 8              | 6,5   | 0,6                                 | 1                                   | 94,6                  | 101,7                 | 121,6                 | 122,8                        | 133,8                 | 0,6                   | 1                     |
|                       | 5.3900         | 0.413 | 0.315          | 0.256 | 0.079                               | 0.039                               | 3.91                  | 4.04                  | 5.12                  | 5.17                         | 5.63                  | 0.079                 | 0.039                 |
|                       | 136,906        | 10,5  | 8              | 6,5   | 2                                   | 1                                   | 99,3                  | 102,5                 | 130,1                 | 131,4                        | 143,1                 | 2                     | 1                     |
| <b>3.75</b><br>95,250 | 5.3900         | 0.413 | 0.315          | 0.256 | 0.024                               | 0.039                               | 3.98                  | 4.28                  | 5.12                  | 5.17                         | 5.63                  | 0.024                 | 0.039                 |
|                       | 136,906        | 10,5  | 8              | 6,5   | 0,6                                 | 1                                   | 101,2                 | 108,6                 | 130,1                 | 131,4                        | 143,1                 | 0,6                   | 1                     |
|                       | 5.7500         | 0.433 | 0.394          | 0.315 | 0.079                               | 0.039                               | 4.17                  | 4.37                  | 5.47                  | 5.49                         | 6.00                  | 0.079                 | 0.039                 |
|                       | 146,050        | 10,5  | 10             | 8     | 2                                   | 1                                   | 105,8                 | 110,9                 | 139                   | 139,5                        | 152,5                 | 2                     | 1                     |
| <b>4</b><br>101,600   | 5.7500         | 0.413 | 0.394          | 0.315 | 0.024                               | 0.039                               | 4.25                  | 4.55                  | 5.47                  | 5.49                         | 6                     | 0.024                 | 0.039                 |
|                       | 146,050        | 10,5  | 10             | 8     | 0,6                                 | 1                                   | 108                   | 115,5                 | 139                   | 139,5                        | 152,5                 | 0,6                   | 1                     |
|                       | 6.4750         | 0.433 | 0.394          | 0.315 | 0.079                               | 0.043                               | 4.45                  | 4.9                   | 6.16                  | 6.18                         | 6.73                  | 0.079                 | 0.043                 |
|                       | 164,465        | 11    | 10             | 8     | 2                                   | 1,1                                 | 113                   | 124,5                 | 156,5                 | 157                          | 171                   | 2                     | 1,1                   |

1) Equal to maximum shaft fillet radius r<sub>a</sub> max.2) Equal to maximum housing fillet radius r<sub>b</sub> max.

Radial spherical plain bearings, steel/steel, inch sizes  
d 4.5 – 6 in

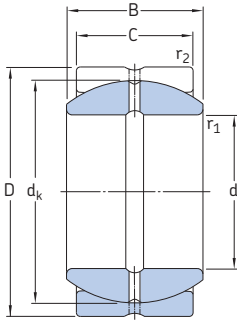

GEZ .. ES

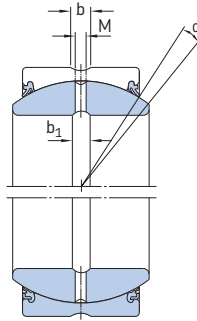

GEZ .. ES-2RS  
GEZ .. ES-2LS

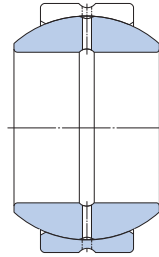

GEZH .. ES

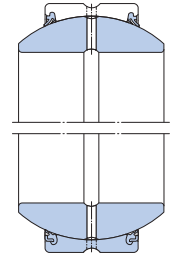

GEZH .. ES-2RS  
GEZH .. ES-2LS

| Principal dimensions   |         |        |        | Angle of tilt <sup>1)</sup> | Basic load ratings |                | Mass  | Designations       |                          |             |      |
|------------------------|---------|--------|--------|-----------------------------|--------------------|----------------|-------|--------------------|--------------------------|-------------|------|
| d                      | D       | B      | C      |                             | dynamic            | static         |       | without seals      | suffix for seal variants |             |      |
|                        |         |        |        | $\alpha$                    | C                  | C <sub>0</sub> |       | standard           | heavy-duty               |             |      |
| in/mm                  |         |        |        | degrees                     | lbf/kN             |                | lb/kg | -                  |                          |             |      |
| <b>4.5</b><br>114,300  | 7.0000  | 3.937  | 3.375  | 6                           | 252 000            | 765 000        | 21.5  | <b>GEZ 408 ES</b>  | <b>-2RS</b>              | <b>-2LS</b> |      |
|                        | 177,800 | 100,00 | 85,73  |                             | 1 120              | 3 400          |       |                    |                          |             | 9,80 |
|                        | 7.7500  | 4.690  | 3.750  |                             | 315 000            | 933 750        |       |                    |                          |             | 36.0 |
|                        | 196,850 | 119,17 | 95,25  |                             | 1 400              | 4 150          | 16,5  |                    |                          |             |      |
| <b>4.75</b><br>120,650 | 7.3750  | 4.156  | 3.562  | 6                           | 281 250            | 843 750        | 25.5  | <b>GEZ 412 ES</b>  | <b>-2RS</b>              | <b>-2LS</b> |      |
|                        | 187,325 | 105,56 | 90,48  |                             | 1 250              | 3 750          |       |                    |                          |             | 11,5 |
| <b>5</b><br>127,000    | 7.7500  | 4.375  | 3.750  | 6                           | 315 000            | 933 750        | 30.0  | <b>GEZ 500 ES</b>  | <b>-2RS</b>              | <b>-2LS</b> |      |
|                        | 196,850 | 111,13 | 95,25  |                             | 1 400              | 4 150          |       |                    |                          |             | 13,5 |
| <b>5.5</b><br>139,700  | 8.7500  | 4.950  | 4.125  | 7                           | 389 250            | 1 170 000      | 45.5  | <b>GEZH 508 ES</b> | <b>-2RS</b>              | <b>-2LS</b> |      |
|                        | 222,250 | 125,73 | 104,78 |                             | 1 730              | 5 200          |       |                    |                          |             | 20,5 |
| <b>6</b><br>152,400    | 8.7500  | 4.750  | 4.125  | 5                           | 389 250            | 1 170 000      | 38.5  | <b>GEZ 600 ES</b>  | <b>-2RS</b>              | <b>-2LS</b> |      |
|                        | 222,250 | 120,65 | 104,78 |                             | 1 730              | 5 200          |       |                    |                          |             | 17,5 |

<sup>1)</sup> To fully utilize the angle of tilt, the shaft shoulder should not be larger than  $d_{a \max}$ .

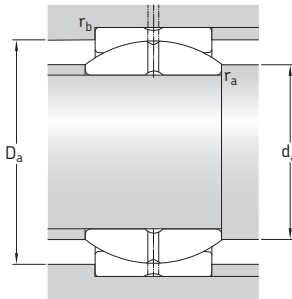

## Dimensions

## Abutment and fillet dimensions

| d              | d <sub>k</sub> | b         | b <sub>1</sub> | M        | r <sub>1</sub> <sup>1)</sup><br>min | r <sub>2</sub> <sup>2)</sup><br>min | d <sub>a</sub><br>min | d <sub>a</sub><br>max | D <sub>a</sub><br>min | D <sub>a</sub> sealed<br>min | D <sub>a</sub><br>max | r <sub>a</sub><br>max | r <sub>b</sub><br>max |
|----------------|----------------|-----------|----------------|----------|-------------------------------------|-------------------------------------|-----------------------|-----------------------|-----------------------|------------------------------|-----------------------|-----------------------|-----------------------|
| in/mm          |                |           |                |          |                                     |                                     | in/mm                 |                       |                       |                              |                       |                       |                       |
| <b>4.5</b>     | 6.4750         | 0.433     | 0.394          | 0.315    | 0.039                               | 0.043                               | 4.82                  | 5.14                  | 6.16                  | 6.18                         | 6.73                  | 0.039                 | 0.043                 |
| <i>114,300</i> | <i>164,465</i> | <i>11</i> | <i>10</i>      | <i>8</i> | <i>1</i>                            | <i>1,1</i>                          | <i>122,5</i>          | <i>130,5</i>          | <i>156,5</i>          | <i>157</i>                   | <i>171</i>            | <i>1</i>              | <i>1,1</i>            |
|                | 7.1900         | 0.433     | 0.394          | 0.315    | 0.079                               | 0.043                               | 4.96                  | 5.45                  | 6.83                  | 6.91                         | 7.42                  | 0.079                 | 0.043                 |
|                | <i>182,626</i> | <i>11</i> | <i>10</i>      | <i>8</i> | <i>2</i>                            | <i>1,1</i>                          | <i>126</i>            | <i>138,4</i>          | <i>173,5</i>          | <i>175,5</i>                 | <i>188,5</i>          | <i>2</i>              | <i>1,1</i>            |
| <b>4.75</b>    | 6.8250         | 0.433     | 0.394          | 0.315    | 0.039                               | 0.043                               | 5.08                  | 5.41                  | 6.5                   | 6.56                         | 7.05                  | 0.039                 | 0.043                 |
| <i>120,650</i> | <i>173,355</i> | <i>11</i> | <i>10</i>      | <i>8</i> | <i>1</i>                            | <i>1,1</i>                          | <i>129</i>            | <i>137,5</i>          | <i>165</i>            | <i>166,5</i>                 | <i>179</i>            | <i>1</i>              | <i>1,1</i>            |
| <b>5</b>       | 7.1900         | 0.433     | 0.394          | 0.315    | 0.039                               | 0.043                               | 5.33                  | 5.69                  | 6.83                  | 6.91                         | 7.42                  | 0.039                 | 0.043                 |
| <i>127,000</i> | <i>182,626</i> | <i>11</i> | <i>10</i>      | <i>8</i> | <i>1</i>                            | <i>1,1</i>                          | <i>135,5</i>          | <i>144,5</i>          | <i>173,5</i>          | <i>175,5</i>                 | <i>188,5</i>          | <i>1</i>              | <i>1,1</i>            |
| <b>5.5</b>     | 8.1560         | 0.591     | 0.433          | 0.315    | 0.079                               | 0.043                               | 5.98                  | 6.46                  | 7.76                  | 7.78                         | 8.41                  | 0.079                 | 0.043                 |
| <i>139,700</i> | <i>207,162</i> | <i>15</i> | <i>11</i>      | <i>8</i> | <i>2</i>                            | <i>1,1</i>                          | <i>152</i>            | <i>164</i>            | <i>197</i>            | <i>197,5</i>                 | <i>213,5</i>          | <i>2</i>              | <i>1,1</i>            |
| <b>6</b>       | 8.1560         | 0.591     | 0.433          | 0.315    | 0.039                               | 0.043                               | 6.34                  | 6.61                  | 7.76                  | 7.78                         | 8.41                  | 0.039                 | 0.043                 |
| <i>152,400</i> | <i>207,162</i> | <i>15</i> | <i>11</i>      | <i>8</i> | <i>1</i>                            | <i>1,1</i>                          | <i>161</i>            | <i>168</i>            | <i>197</i>            | <i>197,5</i>                 | <i>213,5</i>          | <i>1</i>              | <i>1,1</i>            |

<sup>1)</sup> Equal to maximum shaft fillet radius  $r_{a \max}$ .

<sup>2)</sup> Equal to maximum housing fillet radius  $r_{b \max}$ .

**Radial spherical plain bearings with an extended inner ring, steel/steel, metric sizes  
d 12 – 125 mm**

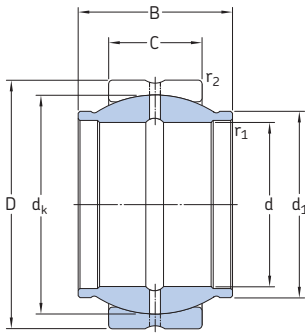

GEG .. ES

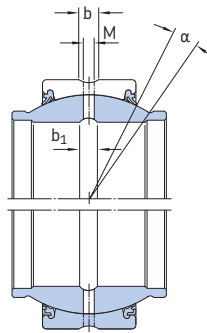

GEM .. ES-2RS  
GEM .. ES-2LS

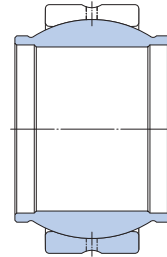

GEG .. ESA

| Principal dimensions |     |     |    | Angle of tilt | Basic load ratings |                | Mass  | Designations <sup>1)</sup>     |                             |
|----------------------|-----|-----|----|---------------|--------------------|----------------|-------|--------------------------------|-----------------------------|
| d                    | D   | B   | C  | $\alpha$      | C                  | C <sub>0</sub> |       | without seals                  | suffix for heavy-duty seals |
|                      |     |     |    | degrees       | kN                 |                | kg    | -                              |                             |
| <b>12</b>            | 22  | 12  | 7  | 4             | 10,8               | 54             | 0,020 | <b>GEG 12 ESA<sup>2)</sup></b> | -                           |
| <b>16</b>            | 28  | 16  | 9  | 4             | 17,6               | 88             | 0,035 | <b>GEG 16 ES</b>               | -                           |
| <b>20</b>            | 35  | 20  | 12 | 4             | 30                 | 146            | 0,070 | <b>GEG 20 ES</b>               | -                           |
|                      | 35  | 24  | 12 | 6             | 30                 | 146            | 0,073 | <b>GEM 20 ES-2RS</b>           | -2LS                        |
| <b>25</b>            | 42  | 25  | 16 | 4             | 48                 | 240            | 0,13  | <b>GEG 25 ES</b>               | -                           |
|                      | 42  | 29  | 16 | 4             | 48                 | 240            | 0,13  | <b>GEM 25 ES-2RS</b>           | -2LS                        |
| <b>30</b>            | 47  | 30  | 18 | 4             | 62                 | 310            | 0,17  | <b>GEM 30 ES-2RS</b>           | -2LS                        |
| <b>32</b>            | 52  | 32  | 18 | 4             | 65,5               | 325            | 0,17  | <b>GEG 32 ES</b>               | -                           |
| <b>35</b>            | 55  | 35  | 20 | 4             | 80                 | 400            | 0,25  | <b>GEM 35 ES-2RS</b>           | -2LS                        |
| <b>40</b>            | 62  | 38  | 22 | 4             | 100                | 500            | 0,35  | <b>GEM 40 ES-2RS</b>           | -2LS                        |
|                      | 62  | 40  | 22 | 4             | 100                | 500            | 0,34  | <b>GEG 40 ES</b>               | -                           |
| <b>45</b>            | 68  | 40  | 25 | 4             | 127                | 640            | 0,49  | <b>GEM 45 ES-2RS</b>           | -2LS                        |
| <b>50</b>            | 75  | 43  | 28 | 4             | 156                | 780            | 0,60  | <b>GEM 50 ES-2RS</b>           | -2LS                        |
|                      | 75  | 50  | 28 | 4             | 156                | 780            | 0,56  | <b>GEG 50 ES</b>               | -                           |
| <b>60</b>            | 90  | 54  | 36 | 3             | 245                | 1 220          | 1,15  | <b>GEM 60 ES-2RS</b>           | -2LS                        |
| <b>63</b>            | 95  | 63  | 36 | 4             | 255                | 1 270          | 1,25  | <b>GEG 63 ES</b>               | -                           |
| <b>70</b>            | 105 | 65  | 40 | 4             | 315                | 1 560          | 1,65  | <b>GEM 70 ES-2RS</b>           | -2LS                        |
| <b>80</b>            | 120 | 74  | 45 | 4             | 400                | 2 000          | 2,50  | <b>GEM 80 ES-2RS</b>           | -2LS                        |
|                      | 120 | 80  | 45 | 4             | 400                | 2 000          | 2,40  | <b>GEG 80 ES</b>               | -                           |
| <b>100</b>           | 150 | 100 | 55 | 4             | 610                | 3 050          | 4,80  | <b>GEG 100 ES</b>              | -                           |
| <b>125</b>           | 180 | 125 | 70 | 4             | 950                | 4 750          | 8,50  | <b>GEG 125 ES</b>              | -                           |

<sup>1)</sup> Bearings with an outside diameter  $D \geq 150$  mm have the multi-groove system in the outer ring as standard. Bearings with an outside diameter  $D < 150$  mm can be supplied with the multi-groove system on request (designation suffix ESL).

<sup>2)</sup> Can only be relubricated via the outer ring.

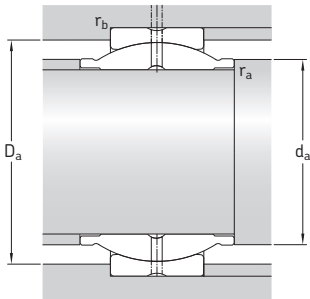

## Dimensions

## Abutment and fillet dimensions

| d   | d <sub>k</sub> | d <sub>1</sub> | b    | b <sub>1</sub> | M   | r <sub>1</sub><br>min | r <sub>2</sub><br>min | d <sub>a</sub><br>min | d <sub>a</sub><br>max | D <sub>a</sub><br>min | D <sub>a</sub><br>max | r <sub>a</sub><br>max | r <sub>b</sub><br>max |
|-----|----------------|----------------|------|----------------|-----|-----------------------|-----------------------|-----------------------|-----------------------|-----------------------|-----------------------|-----------------------|-----------------------|
| mm  |                |                |      |                |     |                       |                       | mm                    |                       |                       |                       |                       |                       |
| 12  | 18             | 15,5           | 2,3  | –              | 1,5 | 0,3                   | 0,3                   | 14,5                  | 15,5                  | 17,1                  | 20,4                  | 0,3                   | 0,3                   |
| 16  | 23             | 20             | 2,3  | 2,3            | 1,5 | 0,3                   | 0,3                   | 18,7                  | 20                    | 21,9                  | 26,3                  | 0,3                   | 0,3                   |
| 20  | 29             | 25             | 3,1  | 3,1            | 2   | 0,3                   | 0,3                   | 23,1                  | 25                    | 27,6                  | 33,2                  | 0,3                   | 0,3                   |
|     | 29             | 24             | 3,1  | 3,1            | 2   | 0,3                   | 0,3                   | 23                    | 24                    | 30,9                  | 33,2                  | 0,3                   | 0,3                   |
| 25  | 35,5           | 30,5           | 3,1  | 3,1            | 2   | 0,6                   | 0,6                   | 29,2                  | 30,5                  | 33,7                  | 39,2                  | 0,6                   | 0,6                   |
|     | 35,5           | 29             | 3,1  | 3,1            | 2   | 0,3                   | 0,6                   | 28,3                  | 29                    | 36,9                  | 39,2                  | 0,3                   | 0,6                   |
| 30  | 40,7           | 34             | 3,1  | 3,1            | 2   | 0,3                   | 0,6                   | 33,5                  | 34                    | 41,3                  | 44                    | 0,3                   | 0,6                   |
| 32  | 43             | 38             | 3,9  | 3,9            | 2,5 | 0,6                   | 1                     | 36,3                  | 38                    | 40,9                  | 48,1                  | 0,6                   | 1                     |
| 35  | 47             | 40             | 3,9  | 3,9            | 2,5 | 0,6                   | 1                     | 38,8                  | 40                    | 48,5                  | 50,9                  | 0,6                   | 1                     |
| 40  | 53             | 45             | 3,9  | 3,9            | 2,5 | 0,6                   | 1                     | 44                    | 45                    | 54,5                  | 57,8                  | 0,6                   | 1                     |
|     | 53             | 46             | 3,9  | 3,9            | 2,5 | 0,6                   | 1                     | 44,8                  | 46                    | 50,3                  | 57,8                  | 0,6                   | 1                     |
| 45  | 60             | 52             | 4,6  | 4,6            | 3   | 0,6                   | 1                     | 49,6                  | 52                    | 61                    | 63,6                  | 0,6                   | 1                     |
| 50  | 66             | 57             | 4,6  | 4,6            | 3   | 0,6                   | 1                     | 54,8                  | 57                    | 66,2                  | 70,5                  | 0,6                   | 1                     |
|     | 66             | 57             | 4,6  | 4,6            | 3   | 0,6                   | 1                     | 55,9                  | 57                    | 62,7                  | 70,5                  | 0,6                   | 1                     |
| 60  | 80             | 68             | 6,2  | 6,2            | 4   | 0,6                   | 1                     | 65,4                  | 68                    | 79,7                  | 84,2                  | 0,6                   | 1                     |
| 63  | 83             | 71,5           | 6,2  | 6,2            | 4   | 1                     | 1                     | 69,7                  | 71,5                  | 78,9                  | 89,2                  | 1                     | 1                     |
| 70  | 92             | 78             | 7,7  | 7,7            | 4   | 0,6                   | 1                     | 75,7                  | 78                    | 92                    | 99                    | 0,6                   | 1                     |
| 80  | 105            | 90             | 7,7  | 7,7            | 4   | 0,6                   | 1                     | 86,1                  | 90                    | 104,4                 | 113,8                 | 0,6                   | 1                     |
|     | 105            | 91             | 7,7  | 7,7            | 4   | 1                     | 1                     | 88,7                  | 91                    | 99,7                  | 113,8                 | 1                     | 1                     |
| 100 | 130            | 113            | 11,3 | 11,3           | 5   | 1                     | 1                     | 110,1                 | 113                   | 123,5                 | 143,2                 | 1                     | 1                     |
| 125 | 160            | 138            | 13,5 | 13,5           | 6   | 1                     | 1                     | 136,5                 | 138                   | 152                   | 172                   | 1                     | 1                     |

Radial spherical plain bearings with an extended inner ring, steel/steel, metric sizes  
d 160 – 200 mm

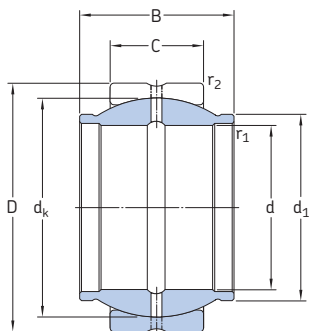

GEG .. ES

| Principal dimensions |     |     |     | Angle of tilt | Basic load ratings |        | Mass | Designation <sup>1)</sup><br>without seals |
|----------------------|-----|-----|-----|---------------|--------------------|--------|------|--|
| d                    | D   | B   | C   | $\alpha$      | dynamic            | static |      |  |
|                      |     |     |     | degrees       | C                  | $C_0$  |      |  |
| mm                   |     |     |     |               | kN                 |        | kg   | –  |
| <b>160</b>           | 230 | 160 | 80  | 4             | 1 370              | 6 800  | 16,5 | <b>GEG 160 ES</b>                          |
| <b>200</b>           | 290 | 200 | 100 | 4             | 2 120              | 10 600 | 32,0 | <b>GEG 200 ES</b>                          |

<sup>1)</sup> Bearings with an outside diameter  $D \geq 150$  mm have the multi-groove system in the outer ring as standard.



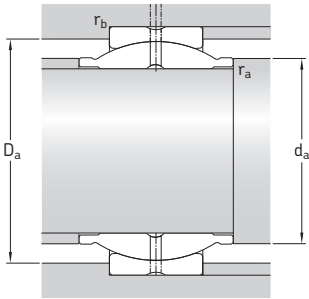

**Dimensions**
**Abutment and fillet dimensions**

| d          | d <sub>k</sub> | d <sub>1</sub> | b    | b <sub>1</sub> | M | r <sub>1</sub><br>min | r <sub>2</sub><br>min | d <sub>a</sub><br>min | d <sub>a</sub><br>max | D <sub>a</sub><br>min | D <sub>a</sub><br>max | r <sub>a</sub><br>max | r <sub>b</sub><br>max |
|------------|----------------|----------------|------|----------------|---|-----------------------|-----------------------|-----------------------|-----------------------|-----------------------|-----------------------|-----------------------|-----------------------|
| mm         |                |                |      |                |   |                       |                       | mm                    |                       |                       |                       |                       |                       |
| <b>160</b> | 200            | 177            | 13,5 | 13,5           | 6 | 1                     | 1                     | 172                   | 177                   | 190                   | 222                   | 1                     | 1                     |
| <b>200</b> | 250            | 221            | 15,5 | 15,5           | 7 | 1,1                   | 1,1                   | 213                   | 221                   | 237,5                 | 279,5                 | 1                     | 1                     |

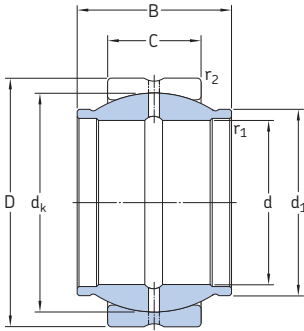
Radial spherical plain bearings with an extended inner ring, steel/steel, inch sizes  
d 0.5 – 2.5 in

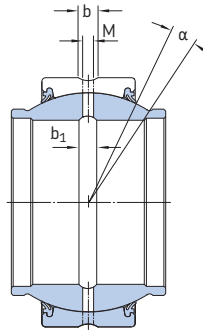

GEZM .. ES



GEZM .. ES-2RS

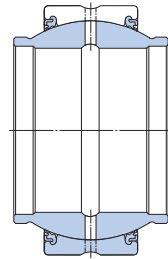

GEZM .. ES-2LS

| Principal dimensions   |                   |                |                | Angle of tilt <sup>1)</sup> |                 | Basic load ratings |                  | Mass           | Designations       | suffix for seal variants |             |
|------------------------|-------------------|----------------|----------------|-----------------------------|-----------------|--------------------|------------------|----------------|--------------------|--------------------------|-------------|
| d                      | D                 | B              | C              | $\alpha$                    | $\alpha$ sealed | C                  | C <sub>0</sub>   |                | without seals      | standard                 | heavy-duty  |
| in/mm                  |                   |                |                | degrees                     |                 | lbf/kN             |                  | lb/kg          | -                  |                          |             |
| <b>0.5</b><br>12,700   | 0.8750<br>22,225  | 0.750<br>19,05 | 0.375<br>9,53  | 9                           | -               | 3 150<br>14        | 9 340<br>41,5    | 0.051<br>0,023 | <b>GEZM 008 ES</b> | -                        | -           |
| <b>0.625</b><br>15,875 | 1.0625<br>26,988  | 0.937<br>23,80 | 0.469<br>11,91 | 9                           | -               | 4 840<br>21,5      | 14 738<br>65,5   | 0.090<br>0,041 | <b>GEZM 010 ES</b> | -                        | -           |
| <b>0.75</b><br>19,050  | 1.2500<br>31,750  | 1.125<br>28,58 | 0.562<br>14,28 | 9                           | 5               | 7 090<br>31,5      | 20 925<br>93     | 0.15<br>0,068  | <b>GEZM 012 ES</b> | <b>-2RS</b>              | -           |
| <b>0.875</b><br>22,225 | 1.4375<br>36,513  | 1.312<br>33,33 | 0.656<br>16,66 | 9                           | -               | 9 560<br>42,5      | 28 575<br>127    | 0.23<br>0,11   | <b>GEZM 014 ES</b> | -                        | -           |
| <b>1</b><br>25,400     | 1.6250<br>41,275  | 1.500<br>38,10 | 0.750<br>19,05 | 9                           | 5               | 12 600<br>56       | 37 350<br>166    | 0.34<br>0,15   | <b>GEZM 100 ES</b> | <b>-2RS</b>              | <b>-2LS</b> |
| <b>1.25</b><br>31,750  | 2.0000<br>50,800  | 1.875<br>47,63 | 0.937<br>23,80 | 9                           | 5               | 19 460<br>86,5     | 58 500<br>260    | 0.63<br>0,29   | <b>GEZM 104 ES</b> | <b>-2RS</b>              | <b>-2LS</b> |
| <b>1.375</b><br>34,925 | 2.1875<br>55,563  | 2.062<br>52,38 | 1.031<br>26,19 | 9                           | 5               | 23 400<br>104      | 69 750<br>310    | 0.81<br>0,37   | <b>GEZM 106 ES</b> | <b>-2RS</b>              | <b>-2LS</b> |
| <b>1.5</b><br>38,100   | 2.4375<br>61,913  | 2.250<br>57,15 | 1.125<br>28,58 | 9                           | 5               | 28 130<br>125      | 84 380<br>375    | 1.15<br>0,51   | <b>GEZM 108 ES</b> | <b>-2RS</b>              | <b>-2LS</b> |
| <b>1.75</b><br>44,450  | 2.8125<br>71,438  | 2.625<br>66,68 | 1.312<br>33,33 | 9                           | 5               | 38 250<br>170      | 114 750<br>510   | 1.80<br>0,81   | <b>GEZM 112 ES</b> | <b>-2RS</b>              | <b>-2LS</b> |
| <b>2</b><br>50,800     | 3.1875<br>80,963  | 3.000<br>76,20 | 1.500<br>38,10 | 9                           | 5               | 50 400<br>224      | 150 750<br>670   | 2.65<br>1,20   | <b>GEZM 200 ES</b> | <b>-2RS</b>              | <b>-2LS</b> |
| <b>2.25</b><br>57,150  | 3.5625<br>90,488  | 3.375<br>85,73 | 1.687<br>42,85 | 9                           | 5               | 63 000<br>280      | 191 250<br>850   | 3.65<br>1,65   | <b>GEZM 204 ES</b> | <b>-2RS</b>              | <b>-2LS</b> |
| <b>2.5</b><br>63,500   | 3.9375<br>100,013 | 3.750<br>95,25 | 1.875<br>47,63 | 9                           | 5               | 77 625<br>350      | 234 000<br>1 040 | 4.95<br>2,25   | <b>GEZM 208 ES</b> | <b>-2RS</b>              | <b>-2LS</b> |

<sup>1)</sup> To fully utilize the angle of tilt, the shaft shoulder should not be larger than  $d_{a \max}$ .

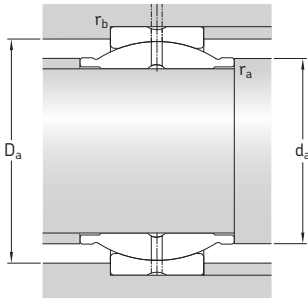

## Dimensions

## Abutment and fillet dimensions

| d                      | d <sub>k</sub>   | d <sub>1</sub> | b            | b <sub>1</sub> | M            | r <sub>1</sub> <sup>1)</sup><br>min | r <sub>2</sub> <sup>2)</sup><br>min | d <sub>a</sub><br>min | d <sub>a</sub><br>max | D <sub>a</sub><br>min | D <sub>a</sub> sealed<br>min | D <sub>a</sub><br>max | r <sub>a</sub><br>max | r <sub>b</sub><br>max |
|------------------------|------------------|----------------|--------------|----------------|--------------|-------------------------------------|-------------------------------------|-----------------------|-----------------------|-----------------------|------------------------------|-----------------------|-----------------------|-----------------------|
| in/mm                  |                  |                |              |                |              |                                     |                                     | in/mm                 |                       |                       |                              |                       |                       |                       |
| <b>0.5</b><br>12,700   | 0.7190<br>18,263 | 0.625<br>15,9  | 0.102<br>2,6 | 0.098<br>2,5   | 0.059<br>1,5 | 0.012<br>0,3                        | 0.024<br>0,6                        | 0.56<br>14,3          | 0.63<br>15,9          | 0.68<br>17,3          | –<br>–                       | 0.78<br>19,9          | 0.012<br>0,3          | 0.024<br>0,6          |
| <b>0.625</b><br>15,875 | 0.8990<br>22,835 | 0.780<br>19,8  | 0.126<br>3,2 | 0.118<br>3     | 0.098<br>2,5 | 0.024<br>0,6                        | 0.039<br>1,0                        | 0.72<br>18,4          | 0.78<br>19,8          | 0.85<br>21,7          | –<br>–                       | 0.93<br>23,6          | 0.024<br>0,6          | 0.039<br>1            |
| <b>0.75</b><br>19,050  | 1.0800<br>27,432 | 0.920<br>23,4  | 0.126<br>3,2 | 0.118<br>3     | 0.098<br>2,5 | 0.024<br>0,6                        | 0.039<br>1,0                        | 0.85<br>21,7          | 0.92<br>23,4          | 1.03<br>26,1          | 1.1<br>27,9                  | 1.11<br>28,3          | 0.024<br>0,6          | 0.039<br>1            |
| <b>0.875</b><br>22,225 | 1.2580<br>31,953 | 1.070<br>27,2  | 0.126<br>3,2 | 0.118<br>3     | 0.098<br>2,5 | 0.024<br>0,6                        | 0.039<br>1,0                        | 0.98<br>24,9          | 1.07<br>27,2          | 1.2<br>30,4           | –<br>–                       | 1.30<br>33            | 0.024<br>0,6          | 0.039<br>1            |
| <b>1</b><br>25,400     | 1.4370<br>36,500 | 1.220<br>31,0  | 0.126<br>3,2 | 0.118<br>3     | 0.098<br>2,5 | 0.024<br>0,6                        | 0.039<br>1,0                        | 1.11<br>28,2          | 1.22<br>31            | 1.37<br>34,7          | 1.39<br>35,2                 | 1.48<br>37,7          | 0.024<br>0,6          | 0.039<br>1            |
| <b>1.25</b><br>31,750  | 1.7950<br>45,593 | 1.525<br>38,7  | 0.189<br>4,8 | 0.197<br>5     | 0.157<br>4   | 0.039<br>1,0                        | 0.039<br>1,0                        | 1.41<br>35,8          | 1.53<br>38,7          | 1.7<br>43,3           | 1.76<br>44,8                 | 1.85<br>47            | 0.039<br>1            | 0.039<br>1            |
| <b>1.375</b><br>34,925 | 1.9370<br>49,200 | 1.670<br>42,4  | 0.189<br>4,8 | 0.197<br>5     | 0.157<br>4   | 0.039<br>1,0                        | 0.039<br>1,0                        | 1.54<br>39,1          | 1.67<br>42,4          | 1.84<br>46,7          | 1.85<br>47,1                 | 2.04<br>51,7          | 0.039<br>1            | 0.039<br>1            |
| <b>1.5</b><br>38,100   | 2.1550<br>54,737 | 1.850<br>47,0  | 0.189<br>4,8 | 0.197<br>5     | 0.157<br>4   | 0.039<br>1,0                        | 0.039<br>1,0                        | 1.71<br>43,3          | 1.85<br>47            | 2.05<br>52            | 2.06<br>52,3                 | 2.28<br>58            | 0.039<br>1            | 0.039<br>1            |
| <b>1.75</b><br>44,450  | 2.5150<br>63,881 | 2.165<br>55,0  | 0.189<br>4,8 | 0.197<br>5     | 0.157<br>4   | 0.039<br>1,0                        | 0.039<br>1,0                        | 1.97<br>49,9          | 2.17<br>55            | 2.39<br>60,7          | 2.41<br>61,3                 | 2.65<br>67,4          | 0.039<br>1            | 0.039<br>1            |
| <b>2</b><br>50,800     | 2.8750<br>73,025 | 2.460<br>62,5  | 0.189<br>4,8 | 0.197<br>5     | 0.157<br>4   | 0.039<br>1,0                        | 0.039<br>1,0                        | 2.22<br>56,5          | 2.46<br>62,5          | 2.73<br>69,4          | 2.85<br>72,4                 | 2.99<br>75,9          | 0.039<br>1            | 0.039<br>1            |
| <b>2.25</b><br>57,150  | 3.2350<br>82,169 | 2.760<br>70,1  | 0.224<br>5,7 | 0.197<br>5     | 0.157<br>4   | 0.039<br>1,0                        | 0.039<br>1,0                        | 2.48<br>63,1          | 2.76<br>70,1          | 3.07<br>78,1          | 3.11<br>79                   | 3.36<br>85,3          | 0.039<br>1            | 0.039<br>1            |
| <b>2.5</b><br>63,500   | 3.5900<br>91,186 | 3.060<br>77,7  | 0.354<br>9   | 0.315<br>8     | 0.256<br>6,5 | 0.039<br>1,0                        | 0.039<br>1,0                        | 2.74<br>69,6          | 3.06<br>77,7          | 3.41<br>86,6          | 3.43<br>87                   | 3.73<br>94,7          | 0.039<br>1            | 0.039<br>1            |

<sup>1)</sup> Equal to maximum shaft fillet radius  $r_{a \max}$ .

<sup>2)</sup> Equal to maximum housing fillet radius  $r_{b \max}$ .

Radial spherical plain bearings with an extended inner ring, steel/steel, inch sizes  
d 2.75 – 6 in

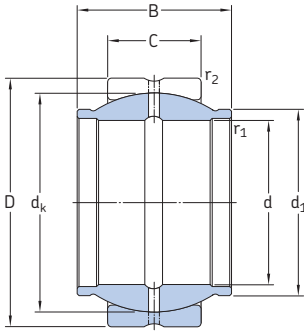

GEZM .. ES

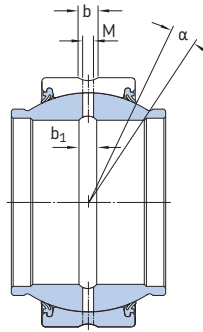

GEZM .. ES-2RS

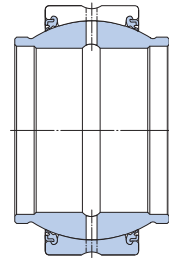

GEZM .. ES-2LS

| Principal dimensions  |                   |                 |                 | Angle of tilt <sup>1)</sup> |                          | Basic load ratings |                    | Mass         | Designations       |                          |             |
|-----------------------|-------------------|-----------------|-----------------|-----------------------------|--------------------------|--------------------|--------------------|--------------|--------------------|--------------------------|-------------|
| d                     | D                 | B               | C               | $\alpha$                    | $\alpha_{\text{sealed}}$ | C                  | C <sub>0</sub>     |              | without seals      | suffix for seal variants |             |
| in/mm                 |                   |                 |                 | degrees                     |                          | lbf/kN             |                    | lb/kg        | -                  |                          |             |
| <b>2.75</b><br>69,850 | 4.3750<br>111,125 | 4.125<br>104,78 | 2.062<br>52,38  | 9                           | 5                        | 95 625<br>430      | 285 750<br>1 270   | 6.85<br>3,10 | <b>GEZM 212 ES</b> | <b>-2RS</b>              | <b>-2LS</b> |
| <b>3</b><br>76,200    | 4.7500<br>120,650 | 4.500<br>114,30 | 2.250<br>57,15  | 9                           | 5                        | 112 500<br>500     | 337 500<br>1 500   | 8.80<br>4,00 | <b>GEZM 300 ES</b> | <b>-2RS</b>              | <b>-2LS</b> |
| <b>3.25</b><br>82,550 | 5.1250<br>130,175 | 4.875<br>123,83 | 2.437<br>61,90  | 9                           | 5                        | 131 625<br>590     | 396 000<br>1 760   | 11.0<br>5,00 | <b>GEZM 304 ES</b> | <b>-2RS</b>              | <b>-2LS</b> |
| <b>3.5</b><br>88,900  | 5.5000<br>139,700 | 5.250<br>133,35 | 2.625<br>66,68  | 9                           | 5                        | 153 000<br>680     | 459 000<br>2 040   | 14.0<br>6,25 | <b>GEZM 308 ES</b> | <b>-2RS</b>              | <b>-2LS</b> |
| <b>3.75</b><br>95,250 | 5.8750<br>149,225 | 5.625<br>142,88 | 2.812<br>71,43  | 9                           | 5                        | 175 500<br>780     | 531 000<br>2 360   | 17.0<br>7,60 | <b>GEZM 312 ES</b> | <b>-2RS</b>              | <b>-2LS</b> |
| <b>4</b><br>101,600   | 6.2500<br>158,750 | 6.000<br>152,40 | 3.000<br>76,20  | 9                           | 5                        | 202 500<br>900     | 596 250<br>2 650   | 20.0<br>9,10 | <b>GEZM 400 ES</b> | <b>-2RS</b>              | <b>-2LS</b> |
| <b>4.5</b><br>114,300 | 7.0000<br>177,800 | 6.750<br>171,45 | 3.375<br>85,73  | 7                           | 5                        | 252 000<br>1 120   | 765 000<br>3 400   | 28.5<br>13,0 | <b>GEZM 408 ES</b> | <b>-2RS</b>              | <b>-2LS</b> |
| <b>5</b><br>127,000   | 7.7500<br>196,850 | 7.500<br>190,50 | 3.750<br>95,25  | 7                           | 5                        | 315 000<br>1 400   | 933 750<br>4 150   | 38.5<br>17,5 | <b>GEZM 500 ES</b> | <b>-2RS</b>              | <b>-2LS</b> |
| <b>6</b><br>152,400   | 8.7500<br>222,250 | 8.250<br>209,55 | 4.125<br>104,78 | 7                           | 5                        | 389 250<br>1 730   | 1 170 000<br>5 200 | 47.5<br>21,5 | <b>GEZM 600 ES</b> | <b>-2RS</b>              | <b>-2LS</b> |

<sup>1)</sup> To fully utilize the angle of tilt, the shaft shoulder should not be larger than  $d_{a \text{ max}}$ .

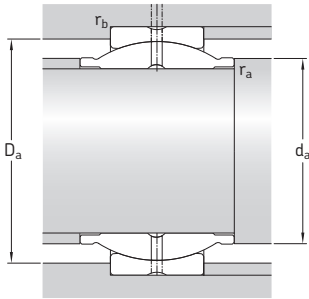

## Dimensions

## Abutment and fillet dimensions

| d                     | d <sub>k</sub>    | d <sub>1</sub> | b             | b <sub>1</sub> | M            | r <sub>1</sub> <sup>1)</sup><br>min | r <sub>2</sub> <sup>2)</sup><br>min | d <sub>a</sub><br>min | d <sub>a</sub><br>max | D <sub>a</sub><br>min | D <sub>a</sub> sealed<br>min | D <sub>a</sub><br>max | r <sub>a</sub><br>max | r <sub>b</sub><br>max |
|-----------------------|-------------------|----------------|---------------|----------------|--------------|-------------------------------------|-------------------------------------|-----------------------|-----------------------|-----------------------|------------------------------|-----------------------|-----------------------|-----------------------|
| in/mm                 |                   |                |               |                |              |                                     |                                     | in/mm                 |                       |                       |                              |                       |                       |                       |
| <b>2.75</b><br>69,850 | 3.9500<br>100,330 | 3.380<br>85,9  | 0.354<br>9    | 0.315<br>8     | 0.256<br>6,5 | 0.039<br>1,0                        | 0.039<br>1,0                        | 3.00<br>76,2          | 3.38<br>85,9          | 3.75<br>95,3          | 3.78<br>96                   | 4.16<br>105,7         | 0.039<br>1            | 0.039<br>1            |
| <b>3</b><br>76,200    | 4.3120<br>109,525 | 3.675<br>93,3  | 0.354<br>9    | 0.315<br>8     | 0.256<br>6,5 | 0.039<br>1,0                        | 0.039<br>1,0                        | 3.26<br>82,8          | 3.68<br>93,3          | 4.09<br>104           | 4.13<br>104,8                | 4.53<br>115           | 0.039<br>1            | 0.039<br>1            |
| <b>3.25</b><br>82,550 | 4.6750<br>118,745 | 3.985<br>101,2 | 0.366<br>9,3  | 0.315<br>8     | 0.256<br>6,5 | 0.039<br>1,0                        | 0.039<br>1,0                        | 3.52<br>89,4          | 3.99<br>101,2         | 4.44<br>112,8         | 4.5<br>114,2                 | 4.90<br>124,4         | 0.039<br>1            | 0.039<br>1            |
| <b>3.5</b><br>88,900  | 5.0400<br>128,016 | 4.300<br>109,2 | 0.413<br>10,5 | 0.315<br>8     | 0.256<br>6,5 | 0.039<br>1,0                        | 0.039<br>1,0                        | 3.78<br>95,9          | 4.3<br>109,2          | 4.79<br>121,6         | 4.83<br>122,8                | 5.27<br>133,8         | 0.039<br>1            | 0.039<br>1            |
| <b>3.75</b><br>95,250 | 5.3900<br>136,906 | 4.590<br>116,6 | 0.413<br>10,5 | 0.315<br>8     | 0.256<br>6,5 | 0.039<br>1,0                        | 0.039<br>1,0                        | 4.04<br>102,5         | 4.59<br>116,6         | 5.12<br>130,1         | 5.17<br>131,4                | 5.63<br>143,1         | 0.039<br>1            | 0.039<br>1            |
| <b>4</b><br>101,600   | 5.7500<br>146,050 | 4.905<br>124,6 | 0.413<br>10,5 | 0.394<br>10    | 0.315<br>8   | 0.059<br>1,5                        | 0.039<br>1,0                        | 4.33<br>110           | 4.91<br>124,6         | 5.47<br>139           | 5.49<br>139,5                | 6.00<br>152,5         | 0.059<br>1,5          | 0.039<br>1            |
| <b>4.5</b><br>114,300 | 6.4750<br>164,465 | 5.525<br>140,3 | 0.433<br>11   | 0.394<br>10    | 0.315<br>8   | 0.079<br>2,0                        | 0.043<br>1,1                        | 4.94<br>125,5         | 5.53<br>140,3         | 6.16<br>156,5         | 6.18<br>157                  | 6.73<br>171           | 0.079<br>2            | 0.043<br>1,1          |
| <b>5</b><br>127,000   | 7.1900<br>182,626 | 6.130<br>155,7 | 0.433<br>11   | 0.394<br>10    | 0.315<br>8   | 0.079<br>2,0                        | 0.043<br>1,1                        | 5.45<br>138,5         | 6.13<br>155,7         | 6.83<br>173,5         | 6.91<br>175,5                | 7.42<br>188,5         | 0.079<br>2            | 0.043<br>1,1          |
| <b>6</b><br>152,400   | 8.1560<br>207,162 | 7.020<br>178,3 | 0.591<br>15   | 0.433<br>11    | 0.315<br>8   | 0.079<br>2,0                        | 0.043<br>1,1                        | 6.46<br>164           | 7.02<br>178,3         | 7.76<br>197           | 7.78<br>197,5                | 8.41<br>213,5         | 0.079<br>2            | 0.043<br>1,1          |

<sup>1)</sup> Equal to maximum shaft fillet radius  $r_{a \max}$ .

<sup>2)</sup> Equal to maximum housing fillet radius  $r_{b \max}$ .



# Maintenance-free radial spherical plain bearings

|   |            |
|---|------------|
| Dimensions .....  | 126        |
| Tolerances .....  | 126        |
| Radial internal clearance, preload .....  | 130        |
| Materials .....   | 130        |
| Permissible operating temperature range .....   | 130        |
| <b>Product tables .....</b>   | <b>132</b> |
| 3.1 Maintenance-free radial spherical plain bearings, steel/PTFE sintered bronze,<br>metric sizes ..... | 132        |
| 3.2 Maintenance-free radial spherical plain bearings, steel/PTFE fabric, metric sizes .....             | 134        |
| 3.3 Maintenance-free radial spherical plain bearings, steel/PTFE fabric, inch sizes .....               | 140        |
| 3.4 Maintenance-free radial spherical plain bearings, steel/PTFE FRP, metric sizes .....                | 144        |

## Maintenance-free radial spherical plain bearings

SKF manufactures maintenance-free radial spherical plain bearings in a variety of designs and a wide range of sizes. Three sliding contact surface combinations are available:

- Steel/PTFE sintered bronze, designation suffix C
- Steel/PTFE fabric, designation suffix TX
- Steel/PTFE FRP, designation suffix F

All three sliding contact surface combinations are self-lubricating. Bearings with a steel/PTFE sintered bronze or steel/PTFE fabric sliding contact surface combinations must not be lubricated. Bearings with a steel/PTFE FRP (fibre reinforced polymer) sliding contact surface combination are also maintenance-free; however, occasional relubrication is beneficial to help maximize bearing service life. To facilitate relubrication, steel/PTFE FRP bearings are equipped with lubrication facilities.

The different designs of SKF maintenance-free radial spherical plain bearings are listed in **table 3** on **pages 128 to 129**. Their design depends on the size and series, with the main differences being the material or the design of the outer ring.

### Dimensions

The dimensions of metric maintenance-free radial spherical plain bearings are in accordance with ISO 12240-1:1998. The dimensions of inch bearings in the GEZ series are in accordance with ANSI/ABMA Std. 22.2-1988.

### Tolerances

The dimensional tolerances for metric maintenance-free radial spherical plain bearings are in accordance with ISO 12240-1:1998 and listed in **table 1**.

The dimensional tolerances for inch bearings in the GEZ series are in accordance with ANSI/ABMA Std. 22.2-1988 and listed in **table 2**. The symbols used are explained in the following:

|                |   |
|----------------|---|
| d              | nominal bore diameter                                     |
| $\Delta_{dmp}$ | deviation of the mean bore diameter from the nominal      |
| D              | nominal outside diameter                                  |
| $\Delta_{Dmp}$ | deviation of the mean outside diameter from the nominal   |
| $\Delta_{Bs}$  | deviation of the single inner ring width from the nominal |
| $\Delta_{Cs}$  | deviation of the single outer ring width from the nominal |

For the TX and TXG3 designs, outer ring tolerances apply to dimensions before fracture.



Table 1

## Dimensional tolerances for metric maintenance-free radial spherical plain bearings

| Nominal diameter<br>d, D<br>over |       | Inner ring<br>$\Delta_{dmp}$<br>high low |      | $\Delta_{Bs}$<br>high low |        | Outer ring<br>$\Delta_{Dmp}$<br>high low |      | $\Delta_{Cs}$<br>high low |        |
|----------------------------------|-------|--|------|---------------------------|--------|--|------|---------------------------|--------|
| incl.                            |       | $\mu\text{m}$                            |      | $\mu\text{m}$             |        | $\mu\text{m}$                            |      | $\mu\text{m}$             |        |
| mm                               |       | $\mu\text{m}$                            |      | $\mu\text{m}$             |        | $\mu\text{m}$                            |      | $\mu\text{m}$             |        |
| –                                | 18    | 0  | –8   | 0                         | –120   | 0  | –8   | 0                         | –240   |
| 18                               | 30    | 0  | –10  | 0                         | –120   | 0  | –9   | 0                         | –240   |
| 30                               | 50    | 0  | –12  | 0                         | –120   | 0  | –11  | 0                         | –240   |
| 50                               | 80    | 0  | –15  | 0                         | –150   | 0  | –13  | 0                         | –300   |
| 80                               | 120   | 0  | –20  | 0                         | –200   | 0  | –15  | 0                         | –400   |
| 120                              | 150   | 0  | –25  | 0                         | –250   | 0  | –18  | 0                         | –500   |
| 150                              | 180   | 0  | –25  | 0                         | –250   | 0  | –25  | 0                         | –500   |
| 180                              | 250   | 0  | –30  | 0                         | –300   | 0  | –30  | 0                         | –600   |
| 250                              | 315   | 0  | –35  | 0                         | –350   | 0  | –35  | 0                         | –700   |
| 315                              | 400   | 0  | –40  | 0                         | –400   | 0  | –40  | 0                         | –800   |
| 400                              | 500   | 0  | –45  | 0                         | –450   | 0  | –45  | 0                         | –900   |
| 500                              | 630   | 0  | –50  | 0                         | –500   | 0  | –50  | 0                         | –1 000 |
| 630                              | 800   | 0  | –75  | 0                         | –750   | 0  | –75  | 0                         | –1 100 |
| 800                              | 1 000 | 0  | –100 | 0                         | –1 000 | 0  | –100 | 0                         | –1 200 |
| 1 000                            | 1 250 | 0  | –125 | 0                         | –1 250 | 0  | –125 | 0                         | –1 300 |
| 1 250                            | 1 600 | –  | –    | –                         | –      | 0  | –160 | 0                         | –1 600 |
| 1 600                            | 2 000 | –  | –    | –                         | –      | 0  | –200 | 0                         | –2 000 |

Table 2

## Dimensional tolerances for inch maintenance-free radial spherical plain bearings

| Nominal diameter<br>d, D<br>over |        | Inner ring<br>$\Delta_{dmp}$<br>high low |     | $\Delta_{Bs}$<br>high low |      | Outer ring<br>$\Delta_{Dmp}$<br>high low |     | $\Delta_{Cs}$<br>high low |      |
|----------------------------------|--------|--|-----|---------------------------|------|--|-----|---------------------------|------|
| incl.                            |        | $\mu\text{m}$                            |     | $\mu\text{m}$             |      | $\mu\text{m}$                            |     | $\mu\text{m}$             |      |
| in                               |        | $\mu\text{m}$                            |     | $\mu\text{m}$             |      | $\mu\text{m}$                            |     | $\mu\text{m}$             |      |
| –                                | 2      | 0  | –13 | 0                         | –130 | 0  | –13 | 0                         | –130 |
| 2                                | 3      | 0  | –15 | 0                         | –130 | 0  | –15 | 0                         | –130 |
| 3                                | 3.1875 | 0  | –20 | 0                         | –130 | 0  | –15 | 0                         | –130 |
| 3.1875                           | 4.75   | 0  | –20 | 0                         | –130 | 0  | –20 | 0                         | –130 |
| 4.75                             | 6      | 0  | –25 | 0                         | –130 | 0  | –25 | 0                         | –130 |
| 6                                | 7      | –  | –   | –                         | –    | 0  | –25 | 0                         | –130 |
| 7                                | 8.75   | –  | –   | –                         | –    | 0  | –30 | 0                         | –130 |

Design of maintenance-free radial spherical plain bearings

Sliding contact surface combination

Steel/PTFE sintered bronze

Steel/PTFE fabric

Steel/PTFE FRP

Lining



- 1 PTFE
- 2 Tin bronze
- 3 Sheet steel backing

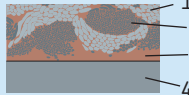

- 1 PTFE fibres
- 2 Reinforcement fibres
- 3 Resin
- 4 Steel backing



- 1 Fibres
- 2 Polymer and PTFE
- 3 Steel backing

Inner ring

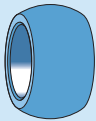

**C and CJ2 designs**

Bearing steel, through-hardened and ground, sliding surface hard chromium plated

**TXA and TXE designs**

Bearing steel, through-hardened and ground, sliding surface hard chromium plated

**Series GEP and GEC**

Bearing steel, through-hardened, ground, sliding surface hard chromium plated

**TXGR, TXG3E and TXG3A designs**

Stainless steel  
X 46 Cr 13/1.4034, hardened, ground

Outer ring



**C design**

Steel backing with PTFE sintered bronze layer pressed around the inner ring, with a butt joint

**CJ2 design**

Steel backing with PTFE sintered bronze sleeve pressed around the inner ring, without a butt joint

**TXA and TXE designs**

Bearing steel, through-hardened and ground

TXA: axially split, held together by one or two bands or bolted together

TXE: fractured at one point

**Series GEP and GEC**

Hardenable steel, ground, FRP shells are retained by side flanges and also glued to the outer ring

Series GEP: radially split, separable

**TXG3A and TXG3E design**

Stainless steel  
X 46 Cr 13/1.4034, hardened, ground,  
TXG3A: axially split, held together by one or two bands

TXG3E: fractured at one point



Series GEC: axially split, held together by two bands ( $d \leq 400$  mm) or bolted together ( $d > 400$  mm)

**TXGR design**

Unhardened stainless steel  
X 17 CrNi 16-2 or equivalent, pressed around the inner ring, no butt joint

Table 3

## Design of maintenance-free radial spherical plain bearings

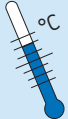
| Sliding contact surface combination  | Steel/PTFE sintered bronze   | Steel/PTFE fabric   | Steel/PTFE FRP   |
|--|--|---|--|
| <b>Seals</b><br>Available on request<br>RS design<br><br>LS design<br> | Available on request   | Bearings with designation suffix -2RS or -2LS (depending on bearing size) have a double- or triple-lip seal on both sides (→ page 79)   | None   |
| <b>Permissible operating temperature range</b><br>  | -50 to +150 °C, for short periods up to +280 °C<br><br>Reduced carrying capacity above 80 °C | Bearings without seals: -50 to +150 °C<br><br>Bearings with RS seals: with a bore diameter $d < 320$ mm: -30 to +130 °C with a bore diameter $d \geq 320$ mm: -35 to +100 °C<br><br>Bearings with LS seals: -50 to +110 °C<br><br>Reduced carrying capacity above 65 °C for both sealed and unsealed bearings | -40 to +75 °C, for short periods up to +110 °C<br><br>Reduced carrying capacity above 50 °C                        |
| <b>Lubrication</b> (refer to the section <i>Lubrication</i> , starting on page 84)   | Self-lubricating; the bearings must not be lubricated  | Self-lubricating; the bearings must not be lubricated   | Greased before leaving factory, self-lubricating capability, however occasional relubrication extends service life |

## Maintenance-free radial spherical plain bearings

### Radial internal clearance, preload

Maintenance-free radial spherical plain bearings with a bore diameter  $d \leq 90$  mm either have an internal clearance or a slight preload (negative clearance) depending on their design. Therefore, these bearings can only be provided with an upper limit for bearing internal clearance. The lower limit must be assessed by the frictional moment, resulting from the preload (negative clearance).

The radial internal clearance and the upper limit of the permissible frictional moment of bearings with a steel/PTFE sintered bronze sliding contact surface are listed in **table 4**. The values for the clearance limits of bearings with a steel/PTFE fabric and a steel/PTFE FRP sliding contact surface combination are listed in **tables 5 to 8**.

### Materials

The materials for the inner ring, outer ring, sliding layer and seals, where applicable, are listed in **table 3** on **pages 128 to 129**.

### Permissible operating temperature range

The permissible operating temperature range of maintenance-free radial spherical plain bearings depends on the sliding contact surface combination and the material of the seals (→ **table 3** on **pages 128 to 129**). However, if the load carrying capacity of the bearings is to be fully exploited, the temperature range must be narrowed. Depending on the application, it is possible to operate at temperatures above the upper limit for brief periods. For additional information, contact the SKF application engineering service.

Table 4

Radial internal clearance and frictional moment of steel/PTFE sintered bronze bearings, metric sizes

| Nominal diameter<br>d |       | Radial internal<br>clearance<br>max | Frictional<br>moment<br>max |
|-----------------------|-------|-------------------------------------|-----------------------------|
| over                  | incl. |                                     |                             |
| mm                    |       | $\mu\text{m}$                       | Nm                          |

#### Series GE .. C, CJ2

|     |    |    |      |
|-----|----|----|------|
| 2,5 | 12 | 28 | 0,15 |
| 12  | 20 | 35 | 0,25 |
| 20  | 30 | 44 | 0,40 |
| 30  | 60 | 53 | 0,75 |

#### Series GEH .. C

|     |    |    |      |
|-----|----|----|------|
| 2,5 | 10 | 28 | 0,15 |
| 10  | 17 | 35 | 0,25 |
| 17  | 25 | 44 | 0,40 |

Table 5

Radial internal clearance for steel/PTFE fabric bearings, metric sizes

| Nominal diameter<br>d |       | Radial internal<br>clearance |     |
|-----------------------|-------|------------------------------|-----|
| over                  | incl. | min                          | max |
| mm                    |       | $\mu\text{m}$                |     |

#### Series

GE .. TXA, TXE, TXGR, TXG3A, TXG3E  
GEH<sup>1)</sup>.. TXA, TXE, TXG3A, TXG3E  
GEC .. TXA

|     |     |     |     |
|-----|-----|-----|-----|
| 12  | 12  | –   | 50  |
| 20  | 20  | –   | 50  |
| 20  | 30  | –   | 50  |
| 30  | 60  | –   | 50  |
| 60  | 90  | –   | 50  |
| 90  | 140 | 50  | 130 |
| 140 | 180 | 50  | 140 |
| 180 | 300 | 80  | 190 |
| 300 | 460 | 100 | 230 |
| 460 | 530 | 100 | 245 |
| 530 | 670 | 100 | 260 |
| 670 | 800 | 100 | 270 |

<sup>1)</sup> Bearings in the GEH .. TX.. series with a bore diameter  $d = 90$  mm have a radial clearance corresponding to the values quoted for the next larger diameter.

Table 6

Radial internal clearance for steel/PTFE fabric bearings, inch sizes

| Nominal diameter d |       | Radial internal clearance |     |
|--------------------|-------|---------------------------|-----|
| over               | incl. | min                       | max |
| in                 |       | µm                        |     |

Series GEZ .. TXE, TXA

|      |      |    |     |
|------|------|----|-----|
| –    | 3    | –  | 50  |
| 3    | 4.75 | 50 | 130 |
| 4.75 |      | 50 | 140 |

Table 7

Radial internal clearance for steel/PTFE FRP bearings, metric sizes

| Bore diameter d |       | Radial internal clearance |     |
|-----------------|-------|---------------------------|-----|
| over            | incl. | min                       | max |
| mm              |       | µm                        |     |

Series GEP .. FS

|     |       |     |     |
|-----|-------|-----|-----|
| 90  | 120   | 85  | 285 |
| 120 | 180   | 100 | 335 |
| 180 | 220   | 100 | 355 |
| 220 | 240   | 110 | 365 |
| 240 | 280   | 110 | 380 |
| 280 | 300   | 135 | 415 |
| 300 | 380   | 135 | 490 |
| 380 | 400   | 135 | 510 |
| 400 | 480   | 145 | 550 |
| 480 | 500   | 145 | 570 |
| 500 | 600   | 160 | 610 |
| 600 | 630   | 160 | 640 |
| 630 | 750   | 170 | 670 |
| 750 | 800   | 170 | 700 |
| 800 | 950   | 195 | 770 |
| 950 | 1 000 | 195 | 820 |

Table 8

Radial internal clearance for steel/PTFE FRP bearings, metric sizes

| Nominal diameter d |       | Radial internal clearance |     |
|--------------------|-------|---------------------------|-----|
| over               | incl. | min                       | max |
| mm                 |       | µm                        |     |

Series GEC .. FBAS

|     |       |     |     |
|-----|-------|-----|-----|
| 300 | 340   | 135 | 350 |
| 340 | 400   | 135 | 360 |
| 400 | 500   | 145 | 390 |
| 500 | 530   | 160 | 420 |
| 530 | 630   | 160 | 440 |
| 630 | 670   | 170 | 460 |
| 670 | 800   | 170 | 490 |
| 800 | 850   | 195 | 530 |
| 850 | 1 000 | 195 | 560 |

Maintenance-free radial spherical plain bearings, steel/PTFE sintered bronze, metric sizes  
d 4 – 60 mm

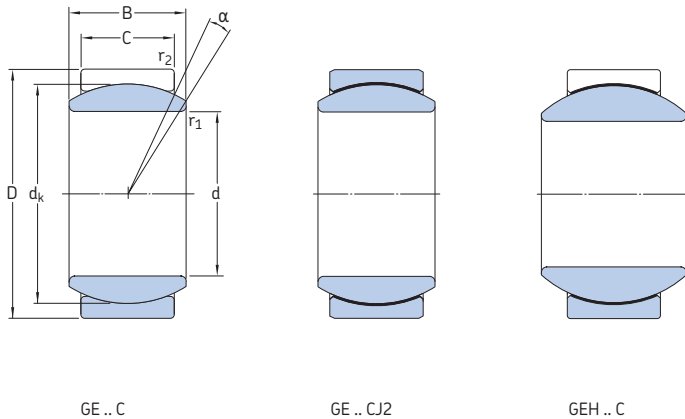

| Principal dimensions |    |    |    | Angle of tilt <sup>1)</sup><br>$\alpha$ | Basic load ratings |                | Mass  | Designation |
|----------------------|----|----|----|---|--------------------|----------------|-------|-------------|
| d                    | D  | B  | C  |   | dynamic            | static         |       |             |
| mm                   |    |    |    | degrees                                 | C                  | C <sub>0</sub> | kg    | –           |
| 4                    | 12 | 5  | 3  | 16                                      | 2,16               | 5,4            | 0,003 | GE 4 C      |
| 6                    | 14 | 6  | 4  | 13                                      | 3,6                | 9              | 0,004 | GE 6 C      |
| 8                    | 16 | 8  | 5  | 15                                      | 5,85               | 14,6           | 0,008 | GE 8 C      |
| 10                   | 19 | 9  | 6  | 12                                      | 8,65               | 21,6           | 0,012 | GE 10 C     |
|                      | 22 | 12 | 7  | 18                                      | 11,4               | 28,5           | 0,020 | GEH 10 C    |
| 12                   | 22 | 10 | 7  | 10                                      | 11,4               | 28,5           | 0,017 | GE 12 C     |
|                      | 26 | 15 | 9  | 18                                      | 18                 | 45             | 0,030 | GEH 12 C    |
| 15                   | 26 | 12 | 9  | 8                                       | 18                 | 45             | 0,032 | GE 15 C     |
|                      | 30 | 16 | 10 | 16                                      | 22,4               | 56             | 0,050 | GEH 15 C    |
| 17                   | 30 | 14 | 10 | 10                                      | 22,4               | 56             | 0,050 | GE 17 C     |
|                      | 35 | 20 | 12 | 19                                      | 31,5               | 78             | 0,090 | GEH 17 C    |
| 20                   | 35 | 16 | 12 | 9                                       | 31,5               | 78             | 0,065 | GE 20 C     |
|                      | 42 | 25 | 16 | 17                                      | 51                 | 127            | 0,16  | GEH 20 C    |
| 25                   | 42 | 20 | 16 | 7                                       | 51                 | 127            | 0,12  | GE 25 C     |
|                      | 47 | 28 | 18 | 17                                      | 65,5               | 166            | 0,20  | GEH 25 C    |
| 30                   | 47 | 22 | 18 | 6                                       | 65,5               | 166            | 0,16  | GE 30 C     |
| 35                   | 55 | 25 | 20 | 6                                       | 80                 | 200            | 0,23  | GE 35 CJ2   |
| 40                   | 62 | 28 | 22 | 7                                       | 100                | 250            | 0,32  | GE 40 CJ2   |
| 45                   | 68 | 32 | 25 | 7                                       | 127                | 320            | 0,46  | GE 45 CJ2   |
| 50                   | 75 | 35 | 28 | 6                                       | 156                | 390            | 0,56  | GE 50 CJ2   |
| 60                   | 90 | 44 | 36 | 6                                       | 245                | 610            | 1,10  | GE 60 CJ2   |

<sup>1)</sup> To fully utilize the angle of tilt, the shaft shoulder should not be larger than  $d_{a \max}$ .

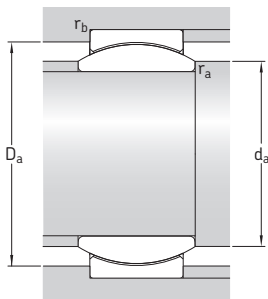

## Dimensions

## Abutment and fillet dimensions

| d  | d <sub>k</sub> | r <sub>1</sub><br>min | r <sub>2</sub><br>min | d <sub>a</sub><br>min | d <sub>a</sub><br>max | D <sub>a</sub><br>min | D <sub>a</sub><br>max | r <sub>a</sub><br>max | r <sub>b</sub><br>max |
|----|----------------|-----------------------|-----------------------|-----------------------|-----------------------|-----------------------|-----------------------|-----------------------|-----------------------|
| mm |                |                       |                       | mm                    |                       |                       |                       |                       |                       |
| 4  | 8              | 0,3                   | 0,3                   | 5,4                   | 6,2                   | 7,6                   | 10,7                  | 0,3                   | 0,3                   |
| 6  | 10             | 0,3                   | 0,3                   | 7,4                   | 8                     | 9,5                   | 12,7                  | 0,3                   | 0,3                   |
| 8  | 13             | 0,3                   | 0,3                   | 9,4                   | 10,2                  | 12,3                  | 14,6                  | 0,3                   | 0,3                   |
| 10 | 16             | 0,3                   | 0,3                   | 11,5                  | 13,2                  | 15,2                  | 17,6                  | 0,3                   | 0,3                   |
|    | 18             | 0,3                   | 0,3                   | 11,6                  | 13,4                  | 17,1                  | 20,6                  | 0,3                   | 0,3                   |
| 12 | 18             | 0,3                   | 0,3                   | 13,5                  | 15                    | 17,1                  | 20,6                  | 0,3                   | 0,3                   |
|    | 22             | 0,3                   | 0,3                   | 13,7                  | 16,1                  | 20,9                  | 24,5                  | 0,3                   | 0,3                   |
| 15 | 22             | 0,3                   | 0,3                   | 16,6                  | 18,4                  | 20,9                  | 24,5                  | 0,3                   | 0,3                   |
|    | 25             | 0,3                   | 0,3                   | 16,7                  | 19,2                  | 23,7                  | 28,5                  | 0,3                   | 0,3                   |
| 17 | 25             | 0,3                   | 0,3                   | 18,7                  | 20,7                  | 23,7                  | 28,5                  | 0,3                   | 0,3                   |
|    | 29             | 0,3                   | 0,3                   | 18,9                  | 21                    | 27,6                  | 33,4                  | 0,3                   | 0,3                   |
| 20 | 29             | 0,3                   | 0,3                   | 21,8                  | 24,2                  | 27,6                  | 33,4                  | 0,3                   | 0,3                   |
|    | 35,5           | 0,3                   | 0,6                   | 22,1                  | 25,2                  | 33,7                  | 39,5                  | 0,3                   | 0,6                   |
| 25 | 35,5           | 0,6                   | 0,6                   | 27,7                  | 29,3                  | 33,7                  | 39,5                  | 0,6                   | 0,6                   |
|    | 40,7           | 0,6                   | 0,6                   | 27,9                  | 29,5                  | 38,7                  | 44,4                  | 0,6                   | 0,6                   |
| 30 | 40,7           | 0,6                   | 0,6                   | 32,8                  | 34,2                  | 38,7                  | 44,4                  | 0,6                   | 0,6                   |
| 35 | 47             | 0,6                   | 1                     | 37,9                  | 39,8                  | 44,7                  | 51,4                  | 0,6                   | 1                     |
| 40 | 53             | 0,6                   | 1                     | 42,9                  | 45                    | 50,4                  | 58,3                  | 0,6                   | 1                     |
| 45 | 60             | 0,6                   | 1                     | 48,7                  | 50,8                  | 57                    | 64,2                  | 0,6                   | 1                     |
| 50 | 66             | 0,6                   | 1                     | 53,9                  | 56                    | 62,7                  | 71,1                  | 0,6                   | 1                     |
| 60 | 80             | 1                     | 1                     | 65,4                  | 66,8                  | 76                    | 85,8                  | 1                     | 1                     |

**Maintenance-free radial spherical plain bearings, steel/PTFE fabric, metric sizes  
d 12 – 90 mm**

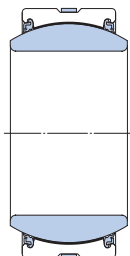
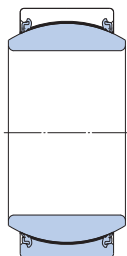
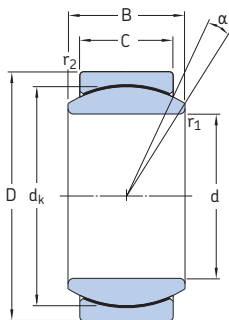

GE ..TXGR

GE ..TX(G3)E-2LS

GE ..TX(G3)A-2LS

| Principal dimensions |     |    |    | Angle of tilt <sup>1)</sup><br>$\alpha$ | Basic load ratings |                | Mass  | Designations<br>Material<br>Bearing steel | Stainless steel                     |
|----------------------|-----|----|----|---|--------------------|----------------|-------|---|-------------------------------------|
| d                    | D   | B  | C  |   | C                  | C <sub>0</sub> |       |   |                                     |
| mm                   |     |    |    | degrees                                 | kN                 |                | kg    | –   |                                     |
| 12                   | 22  | 10 | 7  | 10                                      | 30                 | 50             | 0,017 | –   | GE 12 TXGR                          |
| 15                   | 26  | 12 | 9  | 8                                       | 47,5               | 80             | 0,032 | –   | GE 15 TXGR                          |
| 17                   | 30  | 14 | 10 | 10                                      | 60                 | 100            | 0,050 | –   | GE 17 TXGR                          |
| 20                   | 35  | 16 | 12 | 9                                       | 83                 | 140            | 0,065 | GE 20 TXE-2LS<br>GEH 20 TXE-2LS           | GE 20 TXG3E-2LS<br>GEH 20 TXG3E-2LS |
|                      | 42  | 25 | 16 | 17                                      | 137                | 228            | 0,15  |   |                                     |
| 25                   | 42  | 20 | 16 | 7                                       | 137                | 228            | 0,12  | GE 25 TXE-2LS<br>GEH 25 TXE-2LS           | GE 25 TXG3E-2LS<br>GEH 25 TXG3E-2LS |
|                      | 47  | 28 | 18 | 17                                      | 176                | 290            | 0,19  |   |                                     |
| 30                   | 47  | 22 | 18 | 6                                       | 176                | 290            | 0,16  | GE 30 TXE-2LS<br>GEH 30 TXE-2LS           | GE 30 TXG3E-2LS<br>GEH 30 TXG3E-2LS |
|                      | 55  | 32 | 20 | 17                                      | 224                | 375            | 0,29  |   |                                     |
| 35                   | 55  | 25 | 20 | 6                                       | 224                | 375            | 0,23  | GE 35 TXE-2LS<br>GEH 35 TXE-2LS           | GE 35 TXG3E-2LS<br>GEH 35 TXG3E-2LS |
|                      | 62  | 35 | 22 | 15                                      | 280                | 465            | 0,39  |   |                                     |
| 40                   | 62  | 28 | 22 | 6                                       | 280                | 465            | 0,32  | GE 40 TXE-2LS<br>GEH 40 TXE-2LS           | GE 40 TXG3E-2LS<br>GEH 40 TXG3E-2LS |
|                      | 68  | 40 | 25 | 17                                      | 360                | 600            | 0,52  |   |                                     |
| 45                   | 68  | 32 | 25 | 7                                       | 360                | 600            | 0,46  | GE 45 TXE-2LS<br>GEH 45 TXE-2LS           | GE 45 TXG3E-2LS<br>GEH 45 TXG3E-2LS |
|                      | 75  | 43 | 28 | 14                                      | 440                | 735            | 0,69  |   |                                     |
| 50                   | 75  | 35 | 28 | 6                                       | 440                | 735            | 0,56  | GE 50 TXE-2LS<br>GEH 50 TXE-2LS           | GE 50 TXG3E-2LS<br>GEH 50 TXG3E-2LS |
|                      | 90  | 56 | 36 | 17                                      | 695                | 1160           | 1,41  |   |                                     |
| 60                   | 90  | 44 | 36 | 6                                       | 695                | 1160           | 1,10  | GE 60 TXE-2LS<br>GEH 60 TXE-2LS           | GE 60 TXG3E-2LS<br>GEH 60 TXG3E-2LS |
|                      | 105 | 63 | 40 | 17                                      | 880                | 1460           | 2,06  |   |                                     |
| 70                   | 105 | 49 | 40 | 6                                       | 880                | 1460           | 1,55  | GE 70 TXE-2LS<br>GEH 70 TXE-2LS           | GE 70 TXG3A-2LS<br>GEH 70 TXG3A-2LS |
|                      | 120 | 70 | 45 | 16                                      | 1140               | 1900           | 2,99  |   |                                     |
| 80                   | 120 | 55 | 45 | 5                                       | 1140               | 1900           | 2,30  | GE 80 TXE-2LS<br>GEH 80 TXE-2LS           | GE 80 TXG3A-2LS<br>GEH 80 TXG3A-2LS |
|                      | 130 | 75 | 50 | 14                                      | 1370               | 2320           | 3,55  |   |                                     |
| 90                   | 130 | 60 | 50 | 5                                       | 1370               | 2320           | 2,75  | GE 90 TXE-2LS<br>GEH 90 TXA-2LS           | GE 90 TXG3A-2LS<br>GEH 90 TXG3A-2LS |
|                      | 150 | 85 | 55 | 15                                      | 1730               | 2850           | 5,40  |   |                                     |

<sup>1)</sup> To fully utilize the angle of tilt, the shaft shoulder should not be larger than  $d_{a\max}$ .



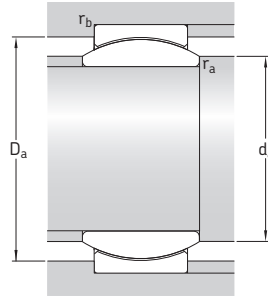
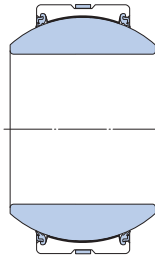
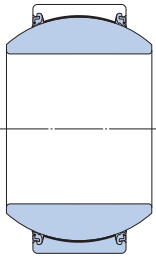

GEH..TX(G3)E-2LS

GEH..TX(G3)A-2LS

**Dimensions****Abutment and fillet dimensions**

| d  | d <sub>k</sub> | r <sub>1</sub><br>min | r <sub>2</sub><br>min | d <sub>a</sub><br>min | d <sub>a</sub><br>max | D <sub>a</sub><br>min | D <sub>a</sub><br>max | r <sub>a</sub><br>max | r <sub>b</sub><br>max |
|----|----------------|-----------------------|-----------------------|-----------------------|-----------------------|-----------------------|-----------------------|-----------------------|-----------------------|
| mm |                |                       |                       | mm                    |                       |                       |                       |                       |                       |
| 12 | 18             | 0,3                   | 0,3                   | 13,8                  | 15                    | 17,1                  | 20,4                  | 0,3                   | 0,3                   |
| 15 | 22             | 0,3                   | 0,3                   | 16,9                  | 18,4                  | 20,9                  | 24,3                  | 0,3                   | 0,3                   |
| 17 | 25             | 0,3                   | 0,3                   | 19                    | 20,7                  | 23,7                  | 28,3                  | 0,3                   | 0,3                   |
| 20 | 29             | 0,3                   | 0,3                   | 22,1                  | 24,2                  | 27,6                  | 33,2                  | 0,3                   | 0,3                   |
|    | 35,5           | 0,3                   | 0,6                   | 22,9                  | 25,2                  | 36,9                  | 39,2                  | 0,3                   | 0,6                   |
| 25 | 35,5           | 0,6                   | 0,6                   | 28,2                  | 29,3                  | 36,9                  | 39,2                  | 0,6                   | 0,6                   |
|    | 40,7           | 0,6                   | 0,6                   | 28,7                  | 29,5                  | 41,3                  | 44                    | 0,6                   | 0,6                   |
| 30 | 40,7           | 0,6                   | 0,6                   | 33,3                  | 34,2                  | 41,3                  | 44                    | 0,6                   | 0,6                   |
|    | 47             | 0,6                   | 1                     | 33,8                  | 34,4                  | 48,5                  | 51                    | 0,6                   | 1                     |
| 35 | 47             | 0,6                   | 1                     | 38,5                  | 39,8                  | 48,5                  | 51                    | 0,6                   | 1                     |
|    | 53             | 0,6                   | 1                     | 39                    | 39,7                  | 54,5                  | 57,5                  | 0,6                   | 1                     |
| 40 | 53             | 0,6                   | 1                     | 43,5                  | 45                    | 54,5                  | 57,5                  | 0,6                   | 1                     |
|    | 60             | 0,6                   | 1                     | 44,2                  | 44,7                  | 61                    | 63,5                  | 0,6                   | 1                     |
| 45 | 60             | 0,6                   | 1                     | 49,5                  | 50,8                  | 61                    | 63,5                  | 0,6                   | 1                     |
|    | 66             | 0,6                   | 1                     | 50                    | 50                    | 66,5                  | 70,5                  | 0,6                   | 1                     |
| 50 | 66             | 0,6                   | 1                     | 54,5                  | 56                    | 66,5                  | 70,5                  | 0,6                   | 1                     |
|    | 80             | 0,6                   | 1                     | 56                    | 57,1                  | 80                    | 84                    | 0,6                   | 1                     |
| 60 | 80             | 1                     | 1                     | 66,5                  | 66,8                  | 80                    | 84                    | 1                     | 1                     |
|    | 92             | 1                     | 1                     | 67                    | 67                    | 92                    | 99                    | 1                     | 1                     |
| 70 | 92             | 1                     | 1                     | 76,5                  | 77,9                  | 92                    | 99                    | 1                     | 1                     |
|    | 105            | 1                     | 1                     | 77,8                  | 78,2                  | 105                   | 113                   | 1                     | 1                     |
| 80 | 105            | 1                     | 1                     | 87                    | 89,4                  | 105                   | 113                   | 1                     | 1                     |
|    | 115            | 1                     | 1                     | 87,1                  | 87,1                  | 113                   | 123                   | 1                     | 1                     |
| 90 | 115            | 1                     | 1                     | 97,5                  | 98,1                  | 113                   | 123                   | 1                     | 1                     |
|    | 130            | 1                     | 1                     | 98,3                  | 98,3                  | 131                   | 144                   | 1                     | 1                     |

**Maintenance-free radial spherical plain bearings, steel/PTFE fabric, metric sizes  
d 100 – 300 mm**

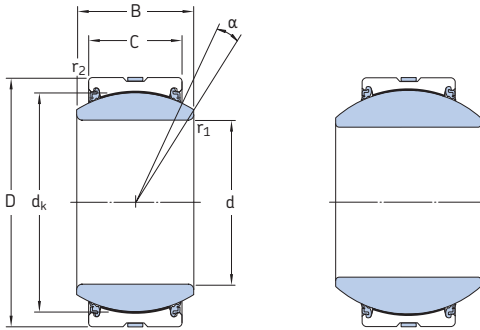

GE .. TX(G3)A-2LS

GEH .. TX(G3)A-2LS

| Principal dimensions |     |     |     | Angle of tilt <sup>1)</sup><br>$\alpha$ | Basic load ratings |        | Mass  | Designations           |                          |
|----------------------|-----|-----|-----|---|--------------------|--------|-------|------------------------|--------------------------|
| d                    | D   | B   | C   |   | dynamic            | static |       | Material               | Bearing steel            |
| mm                   |     |     |     | degrees                                 | kN                 |        | kg    | -                      |                          |
| <b>100</b>           | 150 | 70  | 55  | 6                                       | 1 730              | 2 850  | 4,40  | <b>GE 100 TXA-2LS</b>  | <b>GE 100 TXG3A-2LS</b>  |
|                      | 160 | 85  | 55  | 13                                      | 1 860              | 3 100  | 5,90  | <b>GEH 100 TXA-2LS</b> | <b>GEH 100 TXG3A-2LS</b> |
| <b>110</b>           | 160 | 70  | 55  | 6                                       | 1 860              | 3 100  | 4,80  | <b>GE 110 TXA-2LS</b>  | <b>GE 110 TXG3A-2LS</b>  |
|                      | 180 | 100 | 70  | 12                                      | 2 700              | 4 500  | 9,50  | <b>GEH 110 TXA-2LS</b> | <b>GEH 110 TXG3A-2LS</b> |
| <b>120</b>           | 180 | 85  | 70  | 6                                       | 2 700              | 4 500  | 8,25  | <b>GE 120 TXA-2LS</b>  | <b>GE 120 TXG3A-2LS</b>  |
|                      | 210 | 115 | 70  | 16                                      | 3 000              | 5 000  | 14,90 | <b>GEH 120 TXA-2LS</b> | <b>GEH 120 TXG3A-2LS</b> |
| <b>140</b>           | 210 | 90  | 70  | 7                                       | 3 000              | 5 000  | 11,0  | <b>GE 140 TXA-2LS</b>  | <b>GE 140 TXG3A-2LS</b>  |
| <b>160</b>           | 230 | 105 | 80  | 8                                       | 3 800              | 6 400  | 14,0  | <b>GE 160 TXA-2LS</b>  | <b>GE 160 TXG3A-2LS</b>  |
| <b>180</b>           | 260 | 105 | 80  | 6                                       | 4 300              | 7 200  | 18,5  | <b>GE 180 TXA-2LS</b>  | <b>GE 180 TXG3A-2LS</b>  |
| <b>200</b>           | 290 | 130 | 100 | 7                                       | 6 000              | 10 000 | 28,0  | <b>GE 200 TXA-2LS</b>  | <b>GE 200 TXG3A-2LS</b>  |
| <b>220</b>           | 320 | 135 | 100 | 8                                       | 6 550              | 11 000 | 35,5  | <b>GE 220 TXA-2LS</b>  | -                        |
| <b>240</b>           | 340 | 140 | 100 | 8                                       | 7 200              | 12 000 | 40,0  | <b>GE 240 TXA-2LS</b>  | -                        |
| <b>260</b>           | 370 | 150 | 110 | 7                                       | 8 650              | 14 300 | 51,5  | <b>GE 260 TXA-2LS</b>  | -                        |
| <b>280</b>           | 400 | 155 | 120 | 6                                       | 10 000             | 16 600 | 65,0  | <b>GE 280 TXA-2LS</b>  | -                        |
| <b>300</b>           | 430 | 165 | 120 | 7                                       | 10 800             | 18 000 | 78,5  | <b>GE 300 TXA-2LS</b>  | -                        |

<sup>1)</sup> To fully utilize the angle of tilt, the shaft shoulder should not be larger than  $d_{a \max}$ .

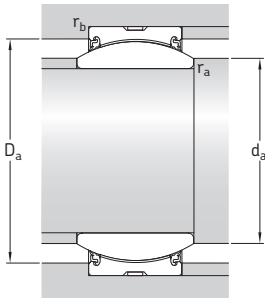

## Dimensions

## Abutment and fillet dimensions

| d          | $d_k$ | $r_{1 \text{ min}}$ | $r_{2 \text{ min}}$ | $d_a \text{ min}$ | $d_a \text{ max}$ | $D_a \text{ min}$ | $D_a \text{ max}$ | $r_a \text{ max}$ | $r_b \text{ max}$ |
|------------|-------|---------------------|---------------------|-------------------|-------------------|-------------------|-------------------|-------------------|-------------------|
| mm         |       |                     |                     | mm                |                   |                   |                   |                   |                   |
| <b>100</b> | 130   | 1                   | 1                   | 108               | 109,5             | 131               | 144               | 1                 | 1                 |
|            | 140   | 1                   | 1                   | 108,5             | 111,2             | 141,5             | 153               | 1                 | 1                 |
| <b>110</b> | 140   | 1                   | 1                   | 118               | 121               | 141,5             | 153               | 1                 | 1                 |
|            | 160   | 1                   | 1                   | 120               | 124,5             | 157,5             | 172               | 1                 | 1                 |
| <b>120</b> | 160   | 1                   | 1                   | 130               | 135,5             | 157,5             | 172               | 1                 | 1                 |
|            | 180   | 1                   | 1                   | 130,5             | 138               | 180               | 202               | 1                 | 1                 |
| <b>140</b> | 180   | 1                   | 1                   | 149               | 155,5             | 180               | 202               | 1                 | 1                 |
| <b>160</b> | 200   | 1                   | 1                   | 170               | 170               | 197               | 222               | 1                 | 1                 |
| <b>180</b> | 225   | 1,1                 | 1,1                 | 191               | 199               | 224,5             | 250               | 1                 | 1                 |
| <b>200</b> | 250   | 1,1                 | 1,1                 | 213               | 213,5             | 244,5             | 279               | 1                 | 1                 |
| <b>220</b> | 275   | 1,1                 | 1,1                 | 233               | 239,5             | 271               | 309               | 1                 | 1                 |
| <b>240</b> | 300   | 1,1                 | 1,1                 | 253               | 265               | 298               | 329               | 1                 | 1                 |
| <b>260</b> | 325   | 1,1                 | 1,1                 | 273               | 288               | 321,5             | 359               | 1                 | 1                 |
| <b>280</b> | 350   | 1,1                 | 1,1                 | 294               | 313,5             | 344,5             | 388               | 1                 | 1                 |
| <b>300</b> | 375   | 1,1                 | 1,1                 | 314               | 336,5             | 371               | 418               | 1                 | 1                 |

**Maintenance-free radial spherical plain bearings, steel/PTFE fabric, metric sizes  
d 320 – 800 mm**

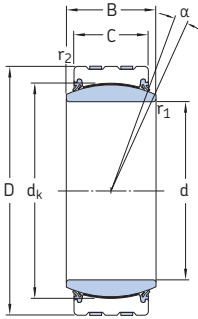

GEC ..TXA-2RS  
d ≤ 400 mm



GEC ..TXA-2RS  
d ≥ 420 mm

| Principal dimensions |       |     |     | Angle of tilt <sup>1)</sup><br>$\alpha$ | Basic load ratings |                 | Mass | Designation     |
|----------------------|-------|-----|-----|---|--------------------|-----------------|------|-----------------|
| d                    | D     | B   | C   |   | dynamic<br>C       | static<br>$C_0$ |      |                 |
| mm                   |       |     |     | degrees                                 | kN                 |                 | kg   | –               |
| 320                  | 440   | 160 | 135 | 4                                       | 14 000             | 23 200          | 75   | GEC 320 TXA-2RS |
| 340                  | 460   | 160 | 135 | 3                                       | 14 600             | 24 500          | 82,5 | GEC 340 TXA-2RS |
| 360                  | 480   | 160 | 135 | 3                                       | 15 300             | 25 500          | 84   | GEC 360 TXA-2RS |
| 380                  | 520   | 190 | 160 | 4                                       | 19 300             | 32 500          | 125  | GEC 380 TXA-2RS |
| 400                  | 540   | 190 | 160 | 3                                       | 20 400             | 34 000          | 130  | GEC 400 TXA-2RS |
| 420                  | 560   | 190 | 160 | 3                                       | 21 200             | 35 500          | 140  | GEC 420 TXA-2RS |
| 440                  | 600   | 218 | 185 | 3                                       | 26 000             | 43 000          | 195  | GEC 440 TXA-2RS |
| 460                  | 620   | 218 | 185 | 3                                       | 27 000             | 45 000          | 200  | GEC 460 TXA-2RS |
| 480                  | 650   | 230 | 195 | 3                                       | 30 000             | 50 000          | 235  | GEC 480 TXA-2RS |
| 500                  | 670   | 230 | 195 | 3                                       | 31 000             | 51 000          | 245  | GEC 500 TXA-2RS |
| 530                  | 710   | 243 | 205 | 3                                       | 34 500             | 57 000          | 290  | GEC 530 TXA-2RS |
| 560                  | 750   | 258 | 215 | 3                                       | 38 000             | 63 000          | 340  | GEC 560 TXA-2RS |
| 600                  | 800   | 272 | 230 | 3                                       | 43 000             | 72 000          | 405  | GEC 600 TXA-2RS |
| 630                  | 850   | 300 | 260 | 3                                       | 52 000             | 86 500          | 525  | GEC 630 TXA-2RS |
| 670                  | 900   | 308 | 260 | 3                                       | 55 000             | 91 500          | 590  | GEC 670 TXA-2RS |
| 710                  | 950   | 325 | 275 | 3                                       | 62 000             | 102 000         | 685  | GEC 710 TXA-2RS |
| 750                  | 1 000 | 335 | 280 | 3                                       | 65 500             | 110 000         | 770  | GEC 750 TXA-2RS |
| 800                  | 1 060 | 355 | 300 | 3                                       | 75 000             | 125 000         | 910  | GEC 800 TXA-2RS |

<sup>1)</sup> To fully utilize the angle of tilt, the shaft shoulder should not be larger than  $d_{a \max}$ .

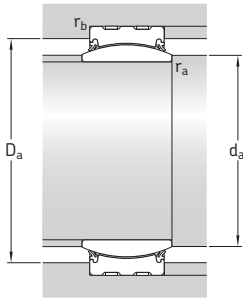

## Dimensions

## Abutment and fillet dimensions

| d   | d <sub>k</sub> | r <sub>1</sub><br>min | r <sub>2</sub><br>min | d <sub>a</sub><br>min | d <sub>a</sub><br>max | D <sub>a</sub><br>min | D <sub>a</sub><br>max | r <sub>a</sub><br>max | r <sub>b</sub><br>max |
|-----|----------------|-----------------------|-----------------------|-----------------------|-----------------------|-----------------------|-----------------------|-----------------------|-----------------------|
| mm  |                |                       |                       | mm                    |                       |                       |                       |                       |                       |
| 320 | 380            | 1,1                   | 3                     | 337                   | 344                   | 376                   | 414                   | 1                     | 3                     |
| 340 | 400            | 1,1                   | 3                     | 357                   | 366                   | 396                   | 434                   | 1                     | 3                     |
| 360 | 420            | 1,1                   | 3                     | 376                   | 388                   | 416                   | 454                   | 1                     | 3                     |
| 380 | 450            | 1,5                   | 4                     | 400                   | 407                   | 445                   | 490                   | 1,5                   | 4                     |
| 400 | 470            | 1,5                   | 4                     | 420                   | 429                   | 465                   | 510                   | 1,5                   | 4                     |
| 420 | 490            | 1,5                   | 4                     | 439                   | 451                   | 485                   | 530                   | 1,5                   | 4                     |
| 440 | 520            | 1,5                   | 4                     | 461                   | 472                   | 514                   | 568                   | 1,5                   | 4                     |
| 460 | 540            | 1,5                   | 4                     | 482                   | 494                   | 534                   | 587                   | 1,5                   | 4                     |
| 480 | 565            | 2                     | 5                     | 504                   | 516                   | 559                   | 613                   | 2                     | 5                     |
| 500 | 585            | 2                     | 5                     | 524                   | 537                   | 579                   | 633                   | 2                     | 5                     |
| 530 | 620            | 2                     | 5                     | 555                   | 570                   | 613                   | 672                   | 2                     | 5                     |
| 560 | 655            | 2                     | 5                     | 585                   | 602                   | 648                   | 711                   | 2                     | 5                     |
| 600 | 700            | 2                     | 5                     | 627                   | 644                   | 692                   | 760                   | 2                     | 5                     |
| 630 | 740            | 3                     | 6                     | 662                   | 676                   | 732                   | 802                   | 3                     | 6                     |
| 670 | 785            | 3                     | 6                     | 702                   | 722                   | 776                   | 853                   | 3                     | 6                     |
| 710 | 830            | 3                     | 6                     | 744                   | 763                   | 821                   | 901                   | 3                     | 6                     |
| 750 | 875            | 3                     | 6                     | 784                   | 808                   | 865                   | 950                   | 3                     | 6                     |
| 800 | 930            | 3                     | 6                     | 835                   | 859                   | 920                   | 1008                  | 3                     | 6                     |

Maintenance-free radial spherical plain bearings, steel/PTFE fabric, inch sizes  
d 1 – 3.75 in

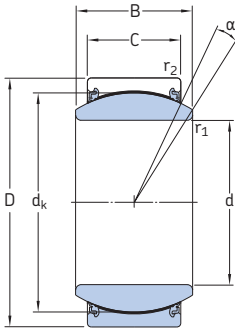

GEZ .. TXE-2LS

| Principal dimensions   |                   |                |                | Angle of tilt | Basic load ratings |                  | Mass         | Designation            |
|------------------------|-------------------|----------------|----------------|---------------|--------------------|------------------|--------------|------------------------|
| d                      | D                 | B              | C              | $\alpha$      | C                  | $C_0$            |              |                        |
| in/mm                  |                   |                |                | degrees       | lbf/kN             |                  | lb/kg        | –                      |
| <b>1</b><br>25,400     | 1.6250<br>41,275  | 0.875<br>22,23 | 0.750<br>19,05 | 6             | 18 680<br>83       | 37 350<br>166    | 0.26<br>0,12 | <b>GEZ 100 TXE-2LS</b> |
| <b>1.25</b><br>31,750  | 2.0000<br>50,800  | 1.093<br>27,76 | 0.937<br>23,80 | 6             | 29 030<br>129      | 58 500<br>260    | 0.51<br>0,23 | <b>GEZ 104 TXE-2LS</b> |
| <b>1.375</b><br>34,925 | 2.1875<br>55,563  | 1.187<br>30,15 | 1.031<br>26,19 | 5             | 35 100<br>156      | 69 750<br>310    | 0.77<br>0,35 | <b>GEZ 106 TXE-2LS</b> |
| <b>1.5</b><br>38,100   | 2.4375<br>61,913  | 1.312<br>33,33 | 1.125<br>28,58 | 6             | 41 850<br>186      | 84 380<br>375    | 0.93<br>0,42 | <b>GEZ 108 TXE-2LS</b> |
| <b>1.75</b><br>44,450  | 2.8125<br>71,438  | 1.531<br>38,89 | 1.312<br>33,33 | 6             | 57 380<br>255      | 114 750<br>510   | 1.40<br>0,64 | <b>GEZ 112 TXE-2LS</b> |
| <b>2</b><br>50,800     | 3.1875<br>80,963  | 1.750<br>44,45 | 1.500<br>38,10 | 6             | 75 380<br>335      | 150 750<br>670   | 2.05<br>0,93 | <b>GEZ 200 TXE-2LS</b> |
| <b>2.25</b><br>57,150  | 3.5625<br>90,488  | 1.969<br>50,01 | 1.687<br>42,85 | 6             | 95 630<br>425      | 191 250<br>850   | 2.85<br>1,30 | <b>GEZ 204 TXE-2LS</b> |
| <b>2.5</b><br>63,500   | 3.9375<br>100,013 | 2.187<br>55,55 | 1.875<br>47,63 | 6             | 117 000<br>520     | 234 000<br>1 040 | 4.10<br>1,85 | <b>GEZ 208 TXE-2LS</b> |
| <b>2.75</b><br>69,850  | 4.3750<br>111,125 | 2.406<br>61,11 | 2.062<br>52,38 | 6             | 141 750<br>630     | 285 750<br>1 270 | 5.30<br>2,40 | <b>GEZ 212 TXE-2LS</b> |
| <b>3</b><br>76,200     | 4.75<br>120,650   | 2.625<br>66,68 | 2.25<br>57,15  | 6             | 168 750<br>750     | 337 500<br>1500  | 6.84<br>3,1  | <b>GEZ 300 TXE-2LS</b> |
| <b>3.25</b><br>82,550  | 5.125<br>130,175  | 2.844<br>72,24 | 2.437<br>61,9  | 6             | 198 000<br>880     | 396 000<br>1760  | 8.38<br>3,8  | <b>GEZ 304 TXE-2LS</b> |
| <b>3.5</b><br>88,900   | 5.5<br>139,700    | 3.062<br>77,78 | 2.625<br>66,68 | 6             | 229 500<br>1020    | 459 000<br>2040  | 10.58<br>4,8 | <b>GEZ 308 TXE-2LS</b> |
| <b>3.75</b><br>95,250  | 5.875<br>149,225  | 3.281<br>83,34 | 2.812<br>71,43 | 6             | 265 500<br>1180    | 531 000<br>2360  | 12.79<br>5,8 | <b>GEZ 312 TXE-2LS</b> |

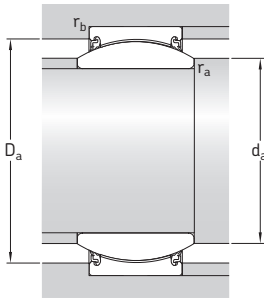

## Dimensions

## Abutment and fillet dimensions

| d                      | d <sub>k</sub>    | r <sub>1</sub><br>min | r <sub>2</sub><br>min | d <sub>a</sub><br>min | d <sub>a</sub><br>max | D <sub>a</sub><br>min | D <sub>a</sub><br>max | r <sub>a</sub><br>max | r <sub>b</sub><br>max |
|------------------------|-------------------|-----------------------|-----------------------|-----------------------|-----------------------|-----------------------|-----------------------|-----------------------|-----------------------|
| in/mm                  |                   | in/mm                 |                       |                       |                       |                       |                       |                       |                       |
| <b>1</b><br>25,400     | 1.4370<br>36,500  | 0.012<br>0,3          | 0.039<br>1            | 1.09<br>27,6          | 1.14<br>28,9          | 1.45<br>36,8          | 1.46<br>37,1          | 0.012<br>0,3          | 0.039<br>1            |
| <b>1.25</b><br>31,750  | 1.7950<br>45,593  | 0.024<br>0,6          | 0.039<br>1            | 1.38<br>35            | 1.42<br>36,1          | 1.81<br>45,9          | 1.83<br>46,4          | 0.024<br>0,6          | 0.039<br>1            |
| <b>1.375</b><br>34,925 | 1.9370<br>49,200  | 0.024<br>0,6          | 0.039<br>1            | 1.51<br>38,3          | 1.53<br>38,8          | 1.93<br>49            | 2.01<br>51            | 0.024<br>0,6          | 0.039<br>1            |
| <b>1.5</b><br>38,100   | 2.1550<br>54,737  | 0.024<br>0,6          | 0.039<br>1            | 1.64<br>41,6          | 1.71<br>43,4          | 2.17<br>55,1          | 2.25<br>57,2          | 0.024<br>0,6          | 0.039<br>1            |
| <b>1.75</b><br>44,450  | 2.5150<br>63,881  | 0.024<br>0,6          | 0.039<br>1            | 1.92<br>48,8          | 1.99<br>50,6          | 2.52<br>64,1          | 2.62<br>66,5          | 0.024<br>0,6          | 0.039<br>1            |
| <b>2</b><br>50,800     | 2.8750<br>73,025  | 0.024<br>0,6          | 0.039<br>1            | 2.18<br>55,4          | 2.28<br>57,9          | 2.85<br>72,4          | 2.95<br>74,9          | 0.024<br>0,6          | 0.039<br>1            |
| <b>2.25</b><br>57,150  | 3.2350<br>82,169  | 0.024<br>0,6          | 0.039<br>1            | 2.44<br>62            | 2.56<br>65,1          | 3.22<br>81,9          | 3.31<br>84,1          | 0.024<br>0,6          | 0.039<br>1            |
| <b>2.5</b><br>63,500   | 3.5900<br>91,186  | 0.024<br>0,6          | 0.039<br>1            | 2.7<br>68,6           | 2.85<br>72,3          | 3.56<br>90,4          | 3.68<br>93,4          | 0.024<br>0,6          | 0.039<br>1            |
| <b>2.75</b><br>69,850  | 3.9500<br>100,330 | 0.024<br>0,6          | 0.039<br>1            | 2.96<br>75,2          | 3.13<br>79,5          | 3.95<br>100,4         | 4.1<br>104,2          | 0.024<br>0,6          | 0.039<br>1            |
| <b>3</b><br>76,200     | 4.3120<br>109,525 | 0.024<br>0,6          | 0.039<br>1            | 3.220<br>81,8         | 3.417<br>86,8         | 4.299<br>109,2        | 4.469<br>113,5        | 0.024<br>0,6          | 0.039<br>1            |
| <b>3.25</b><br>82,550  | 4.675<br>118,745  | 0.024<br>0,6          | 0.039<br>1            | 3.480<br>88,4         | 3.709<br>94,2         | 4.677<br>118,8        | 4.831<br>122,7        | 0.024<br>0,6          | 0.039<br>1            |
| <b>3.5</b><br>88,900   | 5.04<br>128,016   | 0.024<br>0,6          | 0.039<br>1            | 3.740<br>95           | 4.000<br>101,6        | 5.024<br>127,6        | 5.197<br>132          | 0.024<br>0,6          | 0.039<br>1            |
| <b>3.75</b><br>95,250  | 5.39<br>136,906   | 0.024<br>0,6          | 0.039<br>1            | 4.000<br>101,6        | 4.276<br>108,6        | 5.362<br>136,2        | 5.559<br>141,2        | 0.024<br>0,6          | 0.039<br>1            |

Maintenance-free radial spherical plain bearings, steel/PTFE fabric, inch sizes  
d 4 – 6 in

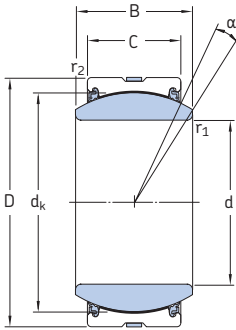

GEZ ..TXA-2LS

| Principal dimensions |         |        |        | Angle of tilt | Basic load ratings |           | Mass   | Designation            |
|----------------------|---------|--------|--------|---------------|--------------------|-----------|--------|------------------------|
| d                    | D       | B      | C      | $\alpha$      | dynamic            | static    |        |                        |
| in/mm                |         |        |        | degrees       | lbf/kN             |           | lb/kg  | –                      |
| <b>4</b>             | 6.25    | 3.5    | 3      | 6             | 301 500            | 596 250   | 15.435 | <b>GEZ 400 TXA-2LS</b> |
| 101,600              | 158,750 | 88,9   | 76,2   |               | 1340               | 2650      | 7      |                        |
| <b>4.5</b>           | 7       | 3.937  | 3.375  | 6             | 382 500            | 765 000   | 21.609 | <b>GEZ 408 TXA-2LS</b> |
| 114,300              | 177,800 | 100    | 85,725 |               | 1700               | 3400      | 9,8    |                        |
| <b>4.75</b>          | 7.375   | 4.156  | 3.562  | 6             | 427 500            | 843 750   | 25.358 | <b>GEZ 412 TXA-2LS</b> |
| 120,650              | 187,325 | 105,56 | 90,48  |               | 1900               | 3750      | 11,5   |                        |
| <b>5</b>             | 7.75    | 4.375  | 3.75   | 6             | 468 000            | 933 750   | 29.768 | <b>GEZ 500 TXA-2LS</b> |
| 127                  | 196,850 | 111,13 | 95,25  |               | 2080               | 4150      | 13,5   |                        |
| <b>6</b>             | 8.75    | 4.75   | 4.125  | 5             | 585 000            | 1 170 000 | 38.588 | <b>GEZ 600 TXA-2LS</b> |
| 152,400              | 222,250 | 120,65 | 104,78 |               | 2600               | 5200      | 17,5   |                        |



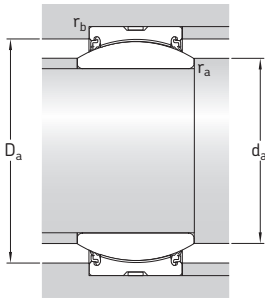

## Dimensions

## Abutment and fillet dimensions

| d           | d <sub>k</sub> | r <sub>1</sub><br>min | r <sub>2</sub><br>min | d <sub>a</sub><br>min | d <sub>a</sub><br>max | D <sub>a</sub><br>min | D <sub>a</sub><br>max | r <sub>a</sub><br>max | r <sub>b</sub><br>max |
|-------------|----------------|-----------------------|-----------------------|-----------------------|-----------------------|-----------------------|-----------------------|-----------------------|-----------------------|
| in/mm       |                | in/mm                 |                       |                       |                       |                       |                       |                       |                       |
| <b>4</b>    | 5.75           | 0.024                 | 0.039                 | 4.272                 | 4.547                 | 5.709                 | 5.925                 | 0.024                 | 0.039                 |
|             | 101,600        | 0,6                   | 1                     | 108,5                 | 115,5                 | 145                   | 150,5                 | 0,6                   | 1                     |
| <b>4.5</b>  | 6.475          | 0.039                 | 0.043                 | 4.843                 | 5.138                 | 6.358                 | 6.634                 | 0.039                 | 0.043                 |
|             | 114,300        | 1                     | 1,1                   | 123                   | 130,5                 | 161,5                 | 168,5                 | 1                     | 1,1                   |
| <b>4.75</b> | 6.825          | 0.039                 | 0.043                 | 5.098                 | 5.413                 | 6.850                 | 6.969                 | 0.039                 | 0.043                 |
|             | 120,650        | 1                     | 1,1                   | 129,5                 | 137,5                 | 174                   | 177                   | 1                     | 1,1                   |
| <b>5</b>    | 7.19           | 0.039                 | 0.043                 | 5.354                 | 5.689                 | 7.106                 | 7.323                 | 0.039                 | 0.043                 |
|             | 127            | 1                     | 1,1                   | 136                   | 144,5                 | 180,5                 | 186                   | 1                     | 1,1                   |
| <b>6</b>    | 8.156          | 0.039                 | 0.043                 | 6.358                 | 6.614                 | 8.012                 | 8.307                 | 0.039                 | 0.043                 |
|             | 152,400        | 1                     | 1,1                   | 161,5                 | 168                   | 203,5                 | 211                   | 1                     | 1,1                   |

Maintenance-free radial spherical plain bearings, steel/PTFE FRP, metric sizes  
d 100 – 420 mm

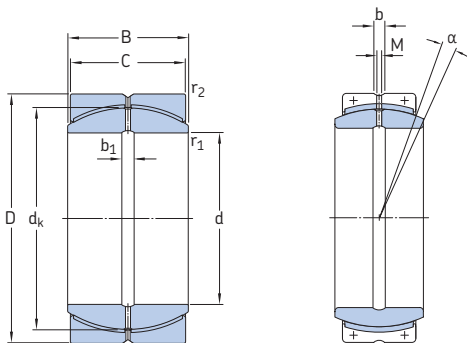

GEP .. FS

GEC .. FBAS

| Principal dimensions |     |     |     | Angle of tilt | Basic load ratings |        | Mass | Designation         |
|----------------------|-----|-----|-----|---------------|--------------------|--------|------|---------------------|
| d                    | D   | B   | C   | $\alpha$      | C                  | $C_0$  |      |                     |
| mm                   |     |     |     | degrees       | kN                 |        | kg   | –                   |
| <b>100</b>           | 150 | 71  | 67  | 2             | 600                | 900    | 4,5  | <b>GEP 100 FS</b>   |
| <b>110</b>           | 160 | 78  | 74  | 2             | 720                | 1 080  | 5,35 | <b>GEP 110 FS</b>   |
| <b>120</b>           | 180 | 85  | 80  | 2             | 850                | 1 270  | 7,95 | <b>GEP 120 FS</b>   |
| <b>140</b>           | 210 | 100 | 95  | 2             | 1 200              | 1 800  | 13   | <b>GEP 140 FS</b>   |
| <b>160</b>           | 230 | 115 | 109 | 2             | 1 600              | 2 400  | 16,5 | <b>GEP 160 FS</b>   |
| <b>180</b>           | 260 | 128 | 122 | 2             | 2 080              | 3 100  | 24,5 | <b>GEP 180 FS</b>   |
| <b>200</b>           | 290 | 140 | 134 | 2             | 2 450              | 3 650  | 33,5 | <b>GEP 200 FS</b>   |
| <b>220</b>           | 320 | 155 | 148 | 2             | 3 050              | 4 550  | 46   | <b>GEP 220 FS</b>   |
| <b>240</b>           | 340 | 170 | 162 | 2             | 3 550              | 5 400  | 53,5 | <b>GEP 240 FS</b>   |
| <b>260</b>           | 370 | 185 | 175 | 2             | 4 250              | 6 400  | 69,5 | <b>GEP 260 FS</b>   |
| <b>280</b>           | 400 | 200 | 190 | 2             | 5 000              | 7 500  | 89,5 | <b>GEP 280 FS</b>   |
| <b>300</b>           | 430 | 212 | 200 | 2             | 5 600              | 8 300  | 110  | <b>GEP 300 FS</b>   |
| <b>320</b>           | 440 | 160 | 135 | 4             | 3 000              | 4 500  | 69,0 | <b>GEC 320 FBAS</b> |
|                      | 460 | 230 | 218 | 2             | 6 400              | 9 650  | 135  | <b>GEP 320 FS</b>   |
| <b>340</b>           | 460 | 160 | 135 | 3             | 3 150              | 4 750  | 73,0 | <b>GEC 340 FBAS</b> |
|                      | 480 | 243 | 230 | 2             | 7 100              | 10 800 | 150  | <b>GEP 340 FS</b>   |
| <b>360</b>           | 480 | 160 | 135 | 3             | 3 250              | 4 900  | 77,0 | <b>GEC 360 FBAS</b> |
|                      | 520 | 258 | 243 | 2             | 8 150              | 12 200 | 200  | <b>GEP 360 FS</b>   |
| <b>380</b>           | 520 | 190 | 160 | 4             | 4 300              | 6 550  | 116  | <b>GEC 380 FBAS</b> |
|                      | 540 | 272 | 258 | 2             | 9 150              | 13 700 | 220  | <b>GEP 380 FS</b>   |
| <b>400</b>           | 540 | 190 | 160 | 3             | 4 500              | 6 700  | 120  | <b>GEC 400 FBAS</b> |
|                      | 580 | 280 | 265 | 2             | 9 650              | 14 600 | 275  | <b>GEP 400 FS</b>   |
| <b>420</b>           | 560 | 190 | 160 | 3             | 4 650              | 6 950  | 126  | <b>GEC 420 FBAS</b> |
|                      | 600 | 300 | 280 | 2             | 10 600             | 16 000 | 300  | <b>GEP 420 FS</b>   |

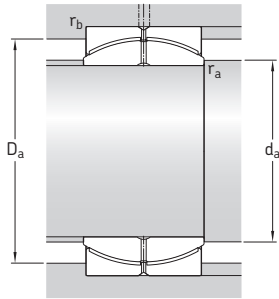

## Dimensions

## Abutment and fillet dimensions

| d   | d <sub>k</sub> | b    | b <sub>1</sub> | M | r <sub>1</sub><br>min | r <sub>2</sub><br>min | d <sub>a</sub><br>min | d <sub>a</sub><br>max | D <sub>a</sub><br>min | D <sub>a</sub><br>max | r <sub>a</sub><br>max | r <sub>b</sub><br>max |
|-----|----------------|------|----------------|---|-----------------------|-----------------------|-----------------------|-----------------------|-----------------------|-----------------------|-----------------------|-----------------------|
| mm  |                |      |                |   |                       |                       | mm                    |                       |                       |                       |                       |                       |
| 100 | 135            | 7,5  | 7,5            | 4 | 1                     | 1                     | 107                   | 114                   | 125,6                 | 141,9                 | 1                     | 1                     |
| 110 | 145            | 7,5  | 7,5            | 4 | 1                     | 1                     | 117                   | 122                   | 135                   | 151                   | 1                     | 1                     |
| 120 | 160            | 7,5  | 7,5            | 4 | 1                     | 1                     | 128                   | 135                   | 149                   | 171                   | 1                     | 1                     |
| 140 | 185            | 7,5  | 7,5            | 4 | 1                     | 1                     | 148                   | 155                   | 173                   | 200                   | 1                     | 1                     |
| 160 | 210            | 7,5  | 7,5            | 4 | 1                     | 1                     | 169                   | 175                   | 195                   | 218                   | 1                     | 1                     |
| 180 | 240            | 7,5  | 7,5            | 4 | 1,1                   | 1,1                   | 191                   | 203                   | 224                   | 246                   | 1                     | 1                     |
| 200 | 260            | 11,5 | 11,5           | 5 | 1,1                   | 1,1                   | 211                   | 219                   | 242                   | 276                   | 1                     | 1                     |
| 220 | 290            | 13,5 | 13,5           | 6 | 1,1                   | 1,1                   | 232                   | 245                   | 270                   | 304                   | 1                     | 1                     |
| 240 | 310            | 13,5 | 13,5           | 6 | 1,1                   | 1,1                   | 253                   | 259                   | 289                   | 323                   | 1                     | 1                     |
| 260 | 340            | 15,5 | 15,5           | 7 | 1,1                   | 1,1                   | 274                   | 285                   | 317                   | 352                   | 1                     | 1                     |
| 280 | 370            | 15,5 | 15,5           | 7 | 1,1                   | 1,1                   | 294                   | 311                   | 345                   | 381                   | 1                     | 1                     |
| 300 | 390            | 15,5 | 15,5           | 7 | 1,1                   | 1,1                   | 315                   | 327                   | 363                   | 411                   | 1                     | 1                     |
| 320 | 380            | 21   | 21             | 8 | 1,1                   | 3                     | 328                   | 344                   | 370                   | 426                   | 1                     | 3                     |
|     | 414            | 21   | 21             | 8 | 1,1                   | 3                     | 335                   | 344                   | 385                   | 434                   | 1                     | 3                     |
| 340 | 400            | 21   | 21             | 8 | 1,1                   | 3                     | 348                   | 366                   | 391                   | 446                   | 1                     | 3                     |
|     | 434            | 21   | 21             | 8 | 1,1                   | 3                     | 356                   | 359                   | 404                   | 453                   | 1                     | 3                     |
| 360 | 420            | 21   | 21             | 8 | 1,1                   | 3                     | 368                   | 388                   | 412,5                 | 466                   | 1                     | 3                     |
|     | 474            | 21   | 21             | 8 | 1,1                   | 4                     | 377                   | 397                   | 441                   | 490                   | 1                     | 4                     |
| 380 | 450            | 21   | 21             | 8 | 1,5                   | 4                     | 389                   | 407                   | 435,5                 | 503                   | 1,5                   | 4                     |
|     | 494            | 21   | 21             | 8 | 1,5                   | 4                     | 398                   | 412                   | 460                   | 508                   | 1,5                   | 4                     |
| 400 | 470            | 21   | 21             | 8 | 1,5                   | 4                     | 409                   | 429                   | 457                   | 523                   | 1,5                   | 4                     |
|     | 514            | 21   | 21             | 8 | 1,5                   | 4                     | 418                   | 431                   | 478                   | 549                   | 1,5                   | 4                     |
| 420 | 490            | 21   | 21             | 8 | 1,5                   | 4                     | 429                   | 451                   | 478,5                 | 543                   | 1,5                   | 4                     |
|     | 534            | 21   | 21             | 8 | 1,5                   | 4                     | 439                   | 441                   | 497                   | 568                   | 1,5                   | 4                     |

Maintenance-free radial spherical plain bearings, steel/PTFE FRP, metric sizes  
d 440 – 850 mm

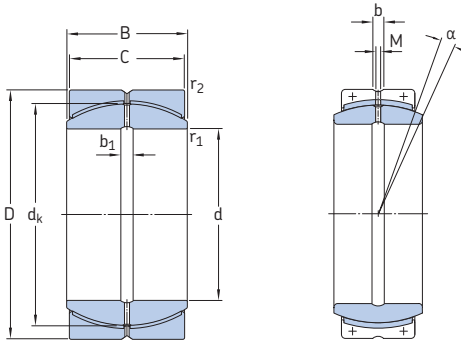

GEP..FS

GEC..FBAS

| Principal dimensions |       |     |     | Angle of tilt | Basic load ratings |        | Mass  | Designation         |
|----------------------|-------|-----|-----|---------------|--------------------|--------|-------|---------------------|
| d                    | D     | B   | C   | $\alpha$      | C                  | $C_0$  |       |                     |
| mm                   |       |     |     | degrees       | kN                 |        | kg    | –                   |
| <b>440</b>           | 600   | 218 | 185 | 3             | 5 850              | 8 800  | 176   | <b>GEC 440 FBAS</b> |
|                      | 630   | 315 | 300 | 2             | 12 200             | 18 600 | 360   | <b>GEP 440 FS</b>   |
| <b>460</b>           | 620   | 218 | 185 | 3             | 6 000              | 9 000  | 182   | <b>GEC 460 FBAS</b> |
|                      | 650   | 325 | 308 | 2             | 12 900             | 19 600 | 380   | <b>GEP 460 FS</b>   |
| <b>480</b>           | 650   | 230 | 195 | 3             | 6 700              | 10 000 | 216   | <b>GEC 480 FBAS</b> |
|                      | 680   | 340 | 320 | 2             | 14 300             | 21 200 | 435   | <b>GEP 480 FS</b>   |
| <b>500</b>           | 670   | 230 | 195 | 3             | 6 800              | 10 200 | 224   | <b>GEC 500 FBAS</b> |
|                      | 710   | 355 | 335 | 2             | 15 300             | 23 200 | 500   | <b>GEP 500 FS</b>   |
| <b>530</b>           | 710   | 243 | 205 | 3             | 7 650              | 11 400 | 266   | <b>GEC 530 FBAS</b> |
|                      | 750   | 375 | 355 | 2             | 17 000             | 25 500 | 585   | <b>GEP 530 FS</b>   |
| <b>560</b>           | 750   | 258 | 215 | 4             | 8 500              | 12 700 | 313   | <b>GEC 560 FBAS</b> |
|                      | 800   | 400 | 380 | 2             | 19 600             | 29 000 | 730   | <b>GEP 560 FS</b>   |
| <b>600</b>           | 800   | 272 | 230 | 3             | 9 800              | 14 600 | 378   | <b>GEC 600 FBAS</b> |
|                      | 850   | 425 | 400 | 2             | 22 000             | 33 500 | 860   | <b>GEP 600 FS</b>   |
| <b>630</b>           | 850   | 300 | 260 | 3             | 11 800             | 18 000 | 494   | <b>GEC 630 FBAS</b> |
|                      | 900   | 450 | 425 | 2             | 24 500             | 37 500 | 1 040 | <b>GEP 630 FS</b>   |
| <b>670</b>           | 900   | 308 | 260 | 3             | 12 500             | 18 600 | 551   | <b>GEC 670 FBAS</b> |
|                      | 950   | 475 | 450 | 2             | 27 500             | 41 500 | 1 210 | <b>GEP 670 FS</b>   |
| <b>710</b>           | 950   | 325 | 275 | 3             | 14 000             | 21 200 | 643   | <b>GEC 710 FBAS</b> |
|                      | 1 000 | 500 | 475 | 2             | 31 000             | 46 500 | 1 400 | <b>GEP 710 FS</b>   |
| <b>750</b>           | 1 000 | 335 | 280 | 3             | 15 000             | 22 400 | 727   | <b>GEC 750 FBAS</b> |
|                      | 1 060 | 530 | 500 | 2             | 34 500             | 52 000 | 1 670 | <b>GEP 750 FS</b>   |
| <b>800</b>           | 1 060 | 355 | 300 | 3             | 17 300             | 26 000 | 861   | <b>GEC 800 FBAS</b> |
|                      | 1 120 | 565 | 530 | 2             | 39 000             | 58 500 | 1 940 | <b>GEP 800 FS</b>   |
| <b>850</b>           | 1 120 | 365 | 310 | 3             | 18 600             | 28 000 | 983   | <b>GEC 850 FBAS</b> |
|                      | 1 220 | 600 | 565 | 2             | 45 000             | 67 000 | 2 600 | <b>GEP 850 FS</b>   |

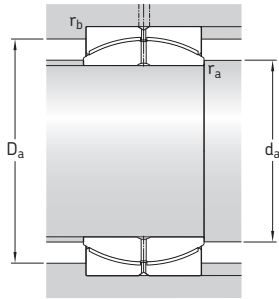

## Dimensions

## Abutment and fillet dimensions

| d          | d <sub>k</sub> | b  | b <sub>1</sub> | M  | r <sub>1</sub><br>min | r <sub>2</sub><br>min | d <sub>a</sub><br>min | d <sub>a</sub><br>max | D <sub>a</sub><br>min | D <sub>a</sub><br>max | r <sub>a</sub><br>max | r <sub>b</sub><br>max |
|------------|----------------|----|----------------|----|-----------------------|-----------------------|-----------------------|-----------------------|-----------------------|-----------------------|-----------------------|-----------------------|
| mm         |                |    |                |    |                       |                       | mm                    |                       |                       |                       |                       |                       |
| <b>440</b> | 520            | 27 | 27             | 10 | 1,5                   | 4                     | 450                   | 472                   | 502                   | 583                   | 1,5                   | 4                     |
|            | 574            | 27 | 27             | 10 | 1,5                   | 4                     | 460                   | 479                   | 534                   | 596                   | 1,5                   | 4                     |
| <b>460</b> | 540            | 27 | 27             | 10 | 1,5                   | 4                     | 470                   | 494                   | 524,5                 | 603                   | 1,5                   | 4                     |
|            | 593            | 27 | 27             | 10 | 1,5                   | 5                     | 481                   | 496                   | 552                   | 612                   | 1,5                   | 5                     |
| <b>480</b> | 565            | 27 | 27             | 10 | 2                     | 5                     | 491                   | 516                   | 547,5                 | 629                   | 2                     | 5                     |
|            | 623            | 27 | 27             | 10 | 2                     | 5                     | 503                   | 522                   | 580                   | 641                   | 2                     | 5                     |
| <b>500</b> | 585            | 27 | 27             | 10 | 2                     | 5                     | 511                   | 537                   | 571                   | 650                   | 2                     | 5                     |
|            | 643            | 27 | 27             | 10 | 2                     | 5                     | 523                   | 536                   | 598                   | 670                   | 2                     | 5                     |
| <b>530</b> | 620            | 27 | 27             | 10 | 2                     | 5                     | 541                   | 570                   | 605                   | 689                   | 2                     | 5                     |
|            | 673            | 27 | 27             | 10 | 2                     | 5                     | 554                   | 558                   | 626                   | 709                   | 2                     | 5                     |
| <b>560</b> | 655            | 27 | 27             | 10 | 2                     | 5                     | 572                   | 602                   | 639                   | 729                   | 2                     | 5                     |
|            | 723            | 27 | 27             | 10 | 2                     | 5                     | 585                   | 602                   | 673                   | 758                   | 2                     | 5                     |
| <b>600</b> | 700            | 27 | 27             | 10 | 2                     | 5                     | 612                   | 644                   | 683                   | 779                   | 2                     | 5                     |
|            | 773            | 27 | 27             | 10 | 2                     | 6                     | 627                   | 645                   | 719                   | 801                   | 2                     | 6                     |
| <b>630</b> | 740            | 35 | 35             | 13 | 3                     | 6                     | 646                   | 676                   | 716                   | 824                   | 3                     | 6                     |
|            | 813            | 35 | 35             | 13 | 3                     | 6                     | 661                   | 677                   | 757                   | 850                   | 3                     | 6                     |
| <b>670</b> | 785            | 35 | 35             | 13 | 3                     | 6                     | 686                   | 722                   | 765                   | 874                   | 3                     | 6                     |
|            | 862            | 35 | 35             | 13 | 3                     | 6                     | 702                   | 719                   | 802                   | 898                   | 3                     | 6                     |
| <b>710</b> | 830            | 35 | 35             | 13 | 3                     | 6                     | 726                   | 763                   | 810                   | 924                   | 3                     | 6                     |
|            | 912            | 35 | 35             | 13 | 3                     | 6                     | 743                   | 762                   | 849                   | 946                   | 3                     | 6                     |
| <b>750</b> | 875            | 35 | 35             | 13 | 3                     | 6                     | 766                   | 808                   | 856                   | 974                   | 3                     | 6                     |
|            | 972            | 35 | 35             | 13 | 3                     | 6                     | 784                   | 814                   | 904                   | 1005                  | 3                     | 6                     |
| <b>800</b> | 930            | 35 | 35             | 13 | 3                     | 6                     | 817                   | 859                   | 907                   | 1033                  | 3                     | 6                     |
|            | 1022           | 35 | 35             | 13 | 3                     | 6                     | 836                   | 851                   | 951                   | 1062                  | 3                     | 6                     |
| <b>850</b> | 985            | 35 | 35             | 13 | 3                     | 6                     | 867                   | 914                   | 963                   | 1093                  | 3                     | 6                     |
|            | 1112           | 35 | 35             | 13 | 3                     | 7,5                   | 888                   | 936                   | 1035                  | 1156                  | 3                     | 7,5                   |

Maintenance-free radial spherical plain bearings, steel/PTFE FRP, metric sizes  
d 900 – 1 000 mm

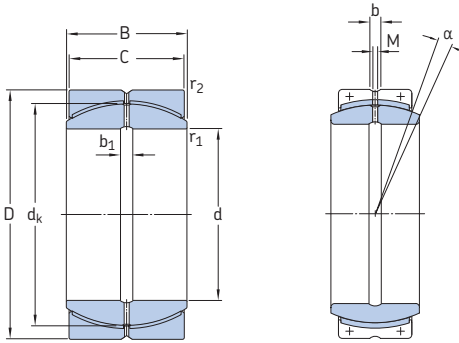

GEP..FS

GEC..FBAS

| Principal dimensions |       |     |     | Angle of tilt | Basic load ratings |        | Mass  | Designation          |
|----------------------|-------|-----|-----|---------------|--------------------|--------|-------|----------------------|
| d                    | D     | B   | C   | $\alpha$      | dynamic            | static |       |                      |
| mm                   |       |     |     | degrees       | kN                 |        | kg    | –                    |
| <b>900</b>           | 1 180 | 375 | 320 | 3             | 20 400             | 31 000 | 1 120 | <b>GEC 900 FBAS</b>  |
|                      | 1 250 | 635 | 600 | 2             | 49 000             | 73 500 | 2 690 | <b>GEP 900 FS</b>    |
| <b>950</b>           | 1 250 | 400 | 340 | 3             | 23 200             | 34 500 | 1 340 | <b>GEC 950 FBAS</b>  |
|                      | 1 360 | 670 | 635 | 2             | 56 000             | 85 000 | 3 620 | <b>GEP 950 FS</b>    |
| <b>1 000</b>         | 1 320 | 438 | 370 | 3             | 27 000             | 40 000 | 1 650 | <b>GEC 1000 FBAS</b> |
|                      | 1 450 | 710 | 670 | 2             | 63 000             | 95 000 | 4 470 | <b>GEP 1000 FS</b>   |

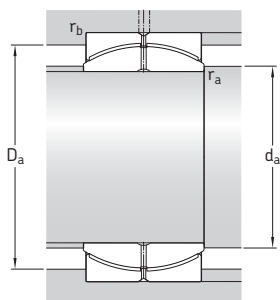

| Dimensions   |                |    |                |    |                       |                       | Abutment and fillet dimensions |                       |                       |                       |                       |                       |
|--------------|----------------|----|----------------|----|-----------------------|-----------------------|--------------------------------|-----------------------|-----------------------|-----------------------|-----------------------|-----------------------|
| d            | d <sub>k</sub> | b  | b <sub>1</sub> | M  | r <sub>1</sub><br>min | r <sub>2</sub><br>min | d <sub>a</sub><br>min          | d <sub>a</sub><br>max | D <sub>a</sub><br>min | D <sub>a</sub><br>max | r <sub>a</sub><br>max | r <sub>b</sub><br>max |
| mm           |                |    |                |    |                       |                       | mm                             |                       |                       |                       |                       |                       |
| <b>900</b>   | 1 040          | 35 | 35             | 13 | 3                     | 6                     | 917                            | 970                   | 1 017                 | 1 153                 | 3                     | 6                     |
|              | 1 142          | 35 | 35             | 13 | 3                     | 7,5                   | 938                            | 949                   | 1 063                 | 1 183                 | 3                     | 7,5                   |
| <b>950</b>   | 1 100          | 40 | 40             | 15 | 4                     | 7,5                   | 969                            | 1 024                 | 1 074                 | 1 217                 | 4                     | 7,5                   |
|              | 1 242          | 40 | 40             | 15 | 4                     | 7,5                   | 993                            | 1 045                 | 1 156                 | 1 290                 | 4                     | 7,5                   |
| <b>1 000</b> | 1 160          | 40 | 40             | 15 | 4                     | 7,5                   | 1 020                          | 1 074                 | 1 128                 | 1 287                 | 4                     | 7,5                   |
|              | 1 312          | 40 | 40             | 15 | 4                     | 7,5                   | 1 045                          | 1 103                 | 1 221                 | 1 378                 | 4                     | 7,5                   |





# Angular contact spherical plain bearings

|   |            |
|---|------------|
| Dimensions .....  | 152        |
| Tolerances .....  | 152        |
| Radial internal clearance, preload .....  | 153        |
| Materials .....   | 154        |
| Permissible operating temperature range .....                                       | 154        |
| Special designs .....   | 154        |
| <b>Product tables .....</b>   | <b>156</b> |
| 4.1 Maintenance-free angular contact spherical plain bearings, steel/PTFE FRP ..... | 156        |

## Angular contact spherical plain bearings

As their name implies, the sliding contact surfaces of angular contact spherical plain bearings are spherical in shape and inclined at an angle to the bearing axis (→ **fig. 1**). Consequently, these bearings are well suited for accommodating combined (radial and axial) loads. Single angular contact spherical plain bearings can only accommodate axial loads acting in one direction. These bearings can be separated, enabling the rings to be mounted separately.

SKF manufactures steel/PTFE FRP (fibre reinforced polymer containing PTFE) maintenance-free angular contact spherical plain bearings as standard. Designs with other sliding surface combinations are available on request (→ *Special designs*, starting on **page 154**).

### Dimensions

The boundary dimensions of SKF angular contact spherical plain bearings are in accordance with ISO 12240-2:1998.

### Tolerances

The dimensional tolerances for SKF angular contact spherical plain bearings are listed in **table 1** and are in accordance with ISO 12240-2:1998.

The symbols used in the tolerance table are explained in the following:

- d nominal bore diameter
- $\Delta_{dmp}$  deviation of the mean bore diameter from the nominal
- D nominal outside diameter
- $\Delta_{Dmp}$  deviation of the mean outside diameter from the nominal
- $\Delta_{Bs}$  deviation of the single inner ring width from the nominal
- $\Delta_{Cs}$  deviation of the single outer ring width from the nominal
- $\Delta_{Ts}$  deviation of the single bearing width from the nominal

**Table 1**

**Dimensional tolerances for angular contact spherical plain bearings**

| Nominal diameter<br>d, D |       | Inner ring<br>$\Delta_{dmp}$ |     | $\Delta_{Bs}$ |      | Outer ring<br>$\Delta_{Dmp}$ |     | $\Delta_{Cs}$ |      | Bearing width<br>$\Delta_{Ts}^{1)}$ |      |
|--------------------------|-------|------------------------------|-----|---------------|------|------------------------------|-----|---------------|------|-------------------------------------|------|
| over                     | incl. | high                         | low | high          | low  | high                         | low | high          | low  | high                                | low  |
| mm                       |       | $\mu\text{m}$                |     |               |      |                              |     |               |      |                                     |      |
| 18                       | 50    | 0                            | -12 | 0             | -240 | 0                            | -14 | 0             | -240 | +250                                | -400 |
| 50                       | 80    | 0                            | -15 | 0             | -300 | 0                            | -16 | 0             | -300 | +250                                | -500 |
| 80                       | 120   | 0                            | -20 | 0             | -400 | 0                            | -18 | 0             | -400 | +250                                | -600 |
| 120                      | 150   | -                            | -   | -             | -    | 0                            | -20 | 0             | -500 | -                                   | -    |
| 150                      | 180   | -                            | -   | -             | -    | 0                            | -25 | 0             | -500 | -                                   | -    |

<sup>1)</sup>The tolerance of the bearing width depends on d.

## Radial internal clearance, preload

The internal clearance of a single angular contact spherical plain bearing is only obtained after mounting and depends on the adjustment against a second bearing that provides axial location in the opposite direction. Angular contact spherical plain bearings are generally mounted as pairs in a back-to-back (→ **fig. 2**) or face-to-face arrangement (→ **fig. 3**). The bearings are adjusted against each other by axially displacing one bearing until a specific bearing load of  $10 \text{ N/mm}^2$  is obtained. The preload prevents some of the deformations that typically occur under load and after a brief running-in period. When adjusting a new bearing arrangement for the first time, the specific bearing load of  $10 \text{ N/mm}^2$  is achieved when the frictional moment and the axial preload force are in the ranges listed in **table 2**.

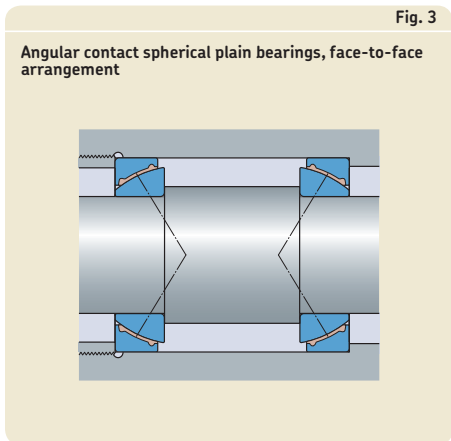
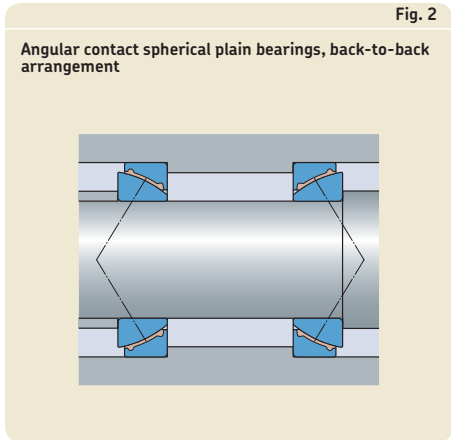
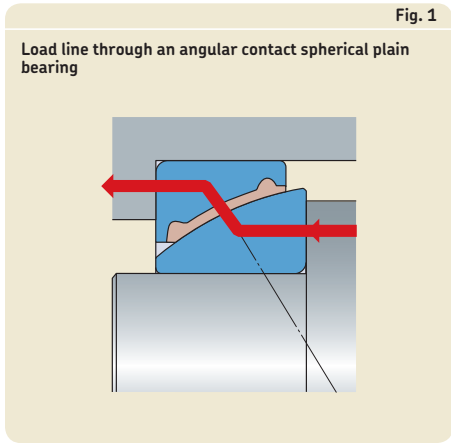

**Table 2**

### Frictional moment and axial preload force

| Bearing   | Frictional moment for $10 \text{ N/mm}^2$ |     | Axial preload force for $10 \text{ N/mm}^2$ |
|-----------|---|-----|---|
|           | min                                       | max |   |
| –         | Nm  |     | N   |
| GAC 25 F  | 7   | 9   | 5 600                                       |
| GAC 30 F  | 12  | 14  | 7 500                                       |
| GAC 35 F  | 16  | 19  | 9 300                                       |
| GAC 40 F  | 21  | 25  | 10 600                                      |
| GAC 45 F  | 26  | 32  | 13 600                                      |
| GAC 50 F  | 31  | 38  | 12 900                                      |
| GAC 60 F  | 51  | 62  | 17 800                                      |
| GAC 70 F  | 76  | 92  | 21 000                                      |
| GAC 80 F  | 105                                       | 126 | 30 000                                      |
| GAC 90 F  | 153                                       | 184 | 41 700                                      |
| GAC 100 F | 180                                       | 216 | 39 500                                      |
| GAC 110 F | 273                                       | 328 | 54 500                                      |
| GAC 120 F | 317                                       | 380 | 69 500                                      |

## Angular contact spherical plain bearings

### Materials

The inner and outer rings of SKF angular contact spherical plain bearings are made of bearing steel that has been through-hardened and ground. The sliding layer of fibre reinforced polymer, containing PTFE, is injection moulded onto the outer ring (→ fig. 4). The sliding surface of the inner ring is hard chromium plated and coated with a lithium base grease.

### Permissible operating temperature range

Spherical plain bearings with a steel/PTFE FRP sliding contact surface combination can be used for operating temperatures ranging from  $-40$  to  $+75$  °C. For brief periods, temperatures up to  $110$  °C can be tolerated. However, keep in mind that the load carrying capacity of the bearing is reduced at temperatures that exceed  $50$  °C. For additional information, contact the SKF application engineering service.

### Special designs

Special operating conditions may require angular contact spherical plain bearings with a steel/PTFE fabric or steel/steel sliding contact surface combination. These bearings are available on request.

Bearings with a maintenance-free steel/PTFE fabric sliding contact surface combination (→ fig. 5) should be used when lubricant-free operation is specified. These bearings can accommodate heavy loads, preferably in a constant direction.

Steel/steel bearings (→ fig. 6) are typically used in applications where operating temperatures or load frequencies are high, or where heavy or shock loads occur. To operate properly, steel/steel bearings must be provided with an adequate supply of lubricant. Depending on the operating conditions, the sliding surface of the outer ring may be equipped with various multi-groove patterns (→ figs. 7 and 8). For additional information, contact the SKF application engineering service.

Upon request, inch steel/steel angular contact spherical plain bearings are also available as double direction angular contact spherical plain bearings. Double direction bearings can be used instead of two angular contact bearings in a face-to-face arrangement, or as a high capacity

Fig. 4

Maintenance-free angular contact spherical plain bearing, steel/PTFE FRP

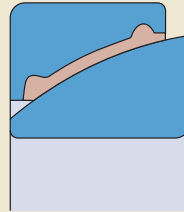

Fig. 5

Maintenance-free angular spherical plain bearing, steel/PTFE fabric

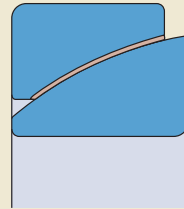

Fig. 6

Angular contact spherical plain bearing, steel/steel, requiring maintenance

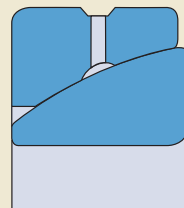

Fig. 7

Angular contact spherical plain bearing with "waffle" grooves, steel/steel

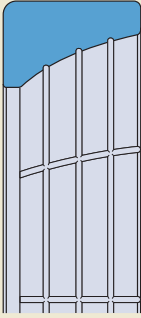

Fig. 8

Angular contact spherical plain bearing with "diamond thread" grooves, steel/steel

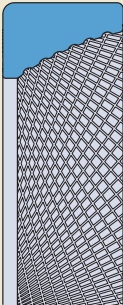
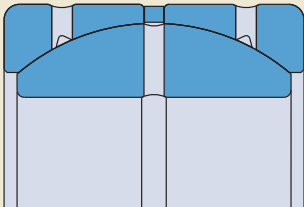

Fig. 9

Double direction angular contact spherical plain bearing in the GEZPR .. S series, steel/steel



radial bearing. Double direction angular contact spherical plain bearings consist of two outer rings and a standard inner ring. SKF supplies these bearings with (GEZPR .. S series) or without (GEZP .. S series) a shim between the two outer rings. The shim simplifies installation and optimizes axial internal clearance within the bearing (→ fig. 9).

Maintenance-free angular contact spherical plain bearings, steel/PTFE FRP  
d 25 – 120 mm

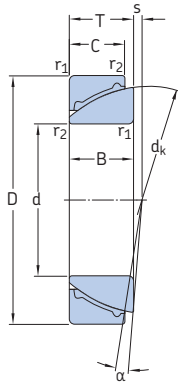

GAC..F

| Principal dimensions |     |    | Angle of tilt<br>$\alpha$ | Basic load ratings |        | Mass | Designation |
|----------------------|-----|----|---------------------------|--------------------|--------|------|-------------|
| d                    | D   | T  |                           | dynamic            | static |      |             |
| mm                   |     |    | degrees                   | kN                 |        | kg   | -           |
| 25                   | 47  | 15 | 3,5                       | 21,6               | 34,5   | 0,14 | GAC 25 F    |
| 30                   | 55  | 17 | 3,5                       | 27                 | 43     | 0,21 | GAC 30 F    |
| 35                   | 62  | 18 | 3,5                       | 32,5               | 52     | 0,27 | GAC 35 F    |
| 40                   | 68  | 19 | 3,5                       | 39                 | 62     | 0,33 | GAC 40 F    |
| 45                   | 75  | 20 | 3                         | 45,5               | 73,5   | 0,42 | GAC 45 F    |
| 50                   | 80  | 20 | 3                         | 53                 | 85     | 0,46 | GAC 50 F    |
| 60                   | 95  | 23 | 3                         | 69,5               | 112    | 0,73 | GAC 60 F    |
| 70                   | 110 | 25 | 2,5                       | 88                 | 143    | 1,05 | GAC 70 F    |
| 80                   | 125 | 29 | 2,5                       | 110                | 176    | 1,55 | GAC 80 F    |
| 90                   | 140 | 32 | 2,5                       | 134                | 216    | 2,10 | GAC 90 F    |
| 100                  | 150 | 32 | 2                         | 170                | 270    | 2,35 | GAC 100 F   |
| 110                  | 170 | 38 | 2                         | 200                | 320    | 3,70 | GAC 110 F   |
| 120                  | 180 | 38 | 1,5                       | 240                | 380    | 4,00 | GAC 120 F   |

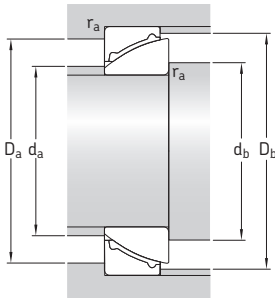

### Dimensions

### Abutment and fillet dimensions

| d   | d <sub>k</sub> | B  | C    | r <sub>1</sub><br>min | r <sub>2</sub><br>min | s    | d <sub>a</sub><br>max | d <sub>b</sub><br>max | D <sub>a</sub><br>min | D <sub>b</sub><br>min | r <sub>a</sub><br>max |
|-----|----------------|----|------|-----------------------|-----------------------|------|-----------------------|-----------------------|-----------------------|-----------------------|-----------------------|
| mm  |                |    |      |                       |                       |      | mm                    |                       |                       |                       |                       |
| 25  | 42             | 15 | 14   | 0,6                   | 0,3                   | 0,6  | 29                    | 39                    | 34                    | 43                    | 0,6                   |
| 30  | 49,5           | 17 | 15   | 1                     | 0,3                   | 1,3  | 35                    | 45                    | 39                    | 50,5                  | 1                     |
| 35  | 55,5           | 18 | 16   | 1                     | 0,3                   | 2,1  | 40                    | 50                    | 45                    | 56,5                  | 1                     |
| 40  | 62             | 19 | 17   | 1                     | 0,3                   | 2,8  | 45                    | 54                    | 50                    | 63                    | 1                     |
| 45  | 68,5           | 20 | 18   | 1                     | 0,3                   | 3,5  | 51                    | 60                    | 55                    | 69                    | 1                     |
| 50  | 74             | 20 | 19   | 1                     | 0,3                   | 4,3  | 56                    | 67                    | 60                    | 74,5                  | 1                     |
| 60  | 88,5           | 23 | 21   | 1,5                   | 0,6                   | 5,7  | 68                    | 77                    | 70                    | 90                    | 1,5                   |
| 70  | 102            | 25 | 23   | 1,5                   | 0,6                   | 7,2  | 78                    | 92                    | 85                    | 103                   | 1,5                   |
| 80  | 115            | 29 | 25,5 | 1,5                   | 0,6                   | 8,6  | 88                    | 104                   | 95                    | 116                   | 1,5                   |
| 90  | 128,5          | 32 | 28   | 2                     | 0,6                   | 10,1 | 101                   | 118                   | 105                   | 129                   | 2                     |
| 100 | 141            | 32 | 31   | 2                     | 0,6                   | 11,6 | 112                   | 128                   | 120                   | 141                   | 2                     |
| 110 | 155            | 38 | 34   | 2,5                   | 0,6                   | 13   | 124                   | 145                   | 130                   | 156                   | 2,5                   |
| 120 | 168            | 38 | 37   | 2,5                   | 0,6                   | 14,5 | 134                   | 155                   | 140                   | 169                   | 2,5                   |





# Thrust spherical plain bearings

|  |            |
|--|------------|
| Dimensions .....   | 160        |
| Tolerances .....   | 160        |
| Materials .....  | 161        |
| Permissible operating temperature range .....                              | 161        |
| Special designs .....  | 162        |
| <b>Product tables .....</b>  | <b>164</b> |
| 5.1 Maintenance-free thrust spherical plain bearings, steel/PTFE FRP ..... | 164        |

## Thrust spherical plain bearings

Thrust spherical plain bearings have a convex spherical surface on the shaft washer and a corresponding concave spherical surface in the housing washer (→ **fig. 1**). They are intended to accommodate primarily axial loads but can also accommodate combined (radial and axial) loads. The radial load component of a combined load should not exceed 50% of the axial load component. When radial loads are larger, it is advisable to combine thrust bearings with radial bearings in the GE dimension series (→ **fig. 2**). Thrust spherical plain bearings are separable, e.g. shaft and housing washers can be mounted separately.

SKF manufactures thrust spherical plain bearings with the maintenance-free steel/PTFE FRP (fibre reinforced polymer containing PTFE) sliding contact surface combination as standard. Other sliding surface combinations are available on request (→ *Special designs*, **page 162**).

### Dimensions

The principal dimensions of SKF thrust spherical plain bearings are in accordance with ISO 12240-3:1998.

### Tolerances

The dimensional tolerances for SKF thrust spherical plain bearings are listed in **table 1** and are in accordance with ISO 12240-3:1998.

The symbols used in the tolerance table are explained in the following:

|                |  |
|----------------|--|
| $d$            | nominal bore diameter (shaft washer)                           |
| $\Delta_{dmp}$ | deviation of the mean bore diameter from the nominal           |
| $D$            | nominal outside diameter (housing washer)                      |
| $\Delta_{Dmp}$ | deviation of the mean outside diameter from the nominal        |
| $\Delta_{Bs}$  | deviation of the single shaft washer height from the nominal   |
| $\Delta_{Cs}$  | deviation of the single housing washer height from the nominal |
| $\Delta_{Ts}$  | deviation of the single thrust bearing height from the nominal |

Fig. 1

Standard thrust spherical plain bearing, steel/PTFE FRP

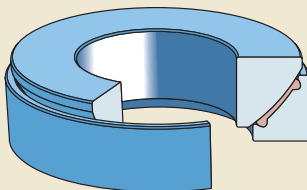
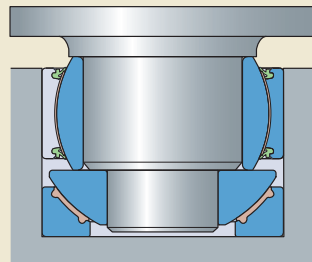

Fig. 2

Combination of a radial and a thrust spherical plain bearing



## Materials

Shaft and housing washers for SKF thrust spherical plain bearings are made of bearing steel that has been through-hardened and ground. The sliding surface of the shaft washer is hard chromium plated and coated with a lithium base grease. The sliding layer of fibre reinforced polymer, containing PTFE, is injection moulded onto the housing washer.

## Permissible operating temperature range

Thrust spherical plain bearings with a steel/PTFE FRP sliding contact surface combination can be used for operating temperatures ranging from  $-40$  to  $+75$  °C. For brief periods, temperatures up to  $110$  °C can be tolerated. However, keep in mind that the load carrying capacity of the bearing is reduced at temperatures that exceed  $50$  °C. For additional information, contact the SKF application engineering service.

Table 1

### Dimensional tolerances for thrust spherical plain bearings

| Nominal diameter<br>d, D |            | Shaft washer   |     |               |      | Housing washer |     |               |      | Bearing height     |      |
|--------------------------|------------|----------------|-----|---------------|------|----------------|-----|---------------|------|--------------------|------|
| over                     | incl.      | $\Delta_{dmp}$ |     | $\Delta_{Bs}$ |      | $\Delta_{Dmp}$ |     | $\Delta_{Cs}$ |      | $\Delta_{Ts}^{1)}$ |      |
|                          |            | high           | low | high          | low  | high           | low | high          | low  | high               | low  |
| mm                       |            | $\mu\text{m}$  |     |               |      | $\mu\text{m}$  |     |               |      | $\mu\text{m}$      |      |
| -                        | <b>18</b>  | 0              | -8  | 0             | -240 | -              | -   | -             | -    | +250               | -400 |
| <b>18</b>                | <b>30</b>  | 0              | -10 | 0             | -240 | -              | -   | -             | -    | +250               | -400 |
| <b>30</b>                | <b>50</b>  | 0              | -12 | 0             | -240 | 0              | -11 | 0             | -240 | +250               | -400 |
| <b>50</b>                | <b>80</b>  | 0              | -15 | 0             | -300 | 0              | -13 | 0             | -300 | +250               | -500 |
| <b>80</b>                | <b>120</b> | 0              | -20 | 0             | -400 | 0              | -15 | 0             | -400 | +250               | -600 |
| <b>120</b>               | <b>150</b> | -              | -   | -             | -    | 0              | -18 | 0             | -500 | -                  | -    |
| <b>150</b>               | <b>180</b> | -              | -   | -             | -    | 0              | -25 | 0             | -500 | -                  | -    |
| <b>180</b>               | <b>230</b> | -              | -   | -             | -    | 0              | -30 | 0             | -600 | -                  | -    |

<sup>1)</sup> The tolerance of the bearing height is dependent on d.

## Special designs

Special operating conditions may require thrust spherical plain bearings with a steel/steel or steel/PTFE fabric sliding contact combination, which are available on request.

Steel/steel bearings (→ **fig. 3**) are typically used in applications where operating temperatures or load frequencies are high, or where heavy loads or shock loads occur. Steel/steel bearings must be provided with an adequate supply of lubricant. Depending on the operating conditions, the sliding surface of the outer ring may be equipped with various multi-groove patterns.

Bearings with a maintenance-free steel/PTFE fabric sliding contact surface (→ **fig. 4**) should be used when lubricant-free operation is specified. These bearings can accommodate heavy loads, preferably in a constant direction.

Fig. 3

Thrust spherical plain bearing, steel/steel, requiring maintenance

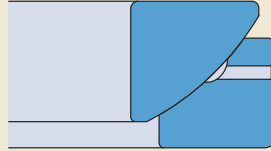
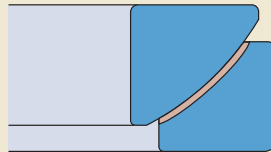

Fig. 4

Maintenance-free thrust spherical plain bearing, steel/PTFE fabric





Maintenance-free thrust spherical plain bearings, steel/PTFE FRP  
d 17 – 120 mm

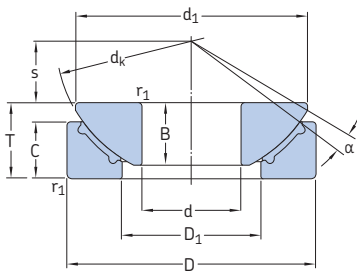

GX..F

| Principal dimensions |     |      | Angle of tilt | Basic load ratings |        | Mass | Designation     |
|----------------------|-----|------|---------------|--------------------|--------|------|-----------------|
| d                    | D   | T    | $\alpha$      | dynamic            | static |      |                 |
| mm                   |     |      | degrees       | kN                 |        | kg   | –               |
| 17                   | 47  | 16   | 5             | 36,5               | 58,5   | 0,14 | <b>GX 17 F</b>  |
| 20                   | 55  | 20   | 5             | 46,5               | 73,5   | 0,25 | <b>GX 20 F</b>  |
| 25                   | 62  | 22,5 | 5             | 69,5               | 112    | 0,42 | <b>GX 25 F</b>  |
| 30                   | 75  | 26   | 5             | 95                 | 153    | 0,61 | <b>GX 30 F</b>  |
| 35                   | 90  | 28   | 6             | 134                | 216    | 0,98 | <b>GX 35 F</b>  |
| 40                   | 105 | 32   | 6             | 173                | 275    | 1,50 | <b>GX 40 F</b>  |
| 45                   | 120 | 36,5 | 6             | 224                | 355    | 2,25 | <b>GX 45 F</b>  |
| 50                   | 130 | 42,5 | 6             | 275                | 440    | 3,15 | <b>GX 50 F</b>  |
| 60                   | 150 | 45   | 6             | 375                | 600    | 4,65 | <b>GX 60 F</b>  |
| 70                   | 160 | 50   | 5             | 475                | 750    | 5,40 | <b>GX 70 F</b>  |
| 80                   | 180 | 50   | 5             | 570                | 915    | 6,95 | <b>GX 80 F</b>  |
| 100                  | 210 | 59   | 5             | 735                | 1 180  | 11,0 | <b>GX 100 F</b> |
| 120                  | 230 | 64   | 4             | 880                | 1 430  | 14,0 | <b>GX 120 F</b> |

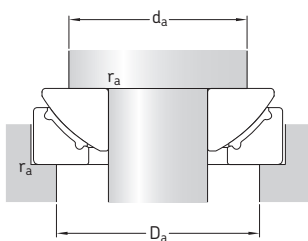

### Dimensions

### Abutment and fillet dimensions

| d   | $d_k$ | $d_1$ | $D_1$ | B    | C    | $r_{1\text{ min}}$ | s    | $d_{a\text{ min}}$ | $D_{a\text{ max}}$ | $r_{a\text{ max}}$ |
|-----|-------|-------|-------|------|------|--------------------|------|--------------------|--------------------|--------------------|
| mm  |       |       |       |      |      |                    |      | mm                 |                    |                    |
| 17  | 52    | 43,5  | 27    | 11,8 | 11,2 | 0,6                | 11   | 34                 | 37                 | 0,6                |
| 20  | 60    | 50    | 31    | 14,5 | 13,8 | 1                  | 12,5 | 40                 | 44                 | 1                  |
| 25  | 68    | 58,5  | 34,5  | 16,5 | 16,7 | 1                  | 14   | 45                 | 47                 | 1                  |
| 30  | 82    | 70    | 42    | 19   | 19   | 1                  | 17,5 | 56                 | 59                 | 1                  |
| 35  | 98    | 84    | 50,5  | 22   | 20,7 | 1                  | 22   | 66                 | 71                 | 1                  |
| 40  | 114   | 97    | 59    | 27   | 21,5 | 1                  | 24,5 | 78                 | 84                 | 1                  |
| 45  | 128   | 110   | 67    | 31   | 25,5 | 1                  | 27,5 | 89                 | 97                 | 1                  |
| 50  | 139   | 120   | 70    | 33   | 30,5 | 1                  | 30   | 98                 | 105                | 1                  |
| 60  | 160   | 140   | 84    | 37   | 34   | 1                  | 35   | 109                | 120                | 1                  |
| 70  | 176   | 153   | 94,5  | 42   | 36,5 | 1                  | 35   | 121                | 125                | 1                  |
| 80  | 197   | 172   | 107,5 | 43,5 | 38   | 1                  | 42,5 | 135                | 145                | 1                  |
| 100 | 222   | 198   | 127   | 51   | 46   | 1                  | 45   | 155                | 170                | 1                  |
| 120 | 250   | 220   | 145   | 53,5 | 50   | 1                  | 52,5 | 170                | 190                | 1                  |





# Rod ends requiring maintenance

|   |            |
|---|------------|
| Dimensions .....  | 168        |
| Tolerances .....  | 168        |
| Radial internal clearance .....   | 169        |
| Materials .....   | 169        |
| Permissible operating temperature range .....                                 | 170        |
| Fatigue strength .....  | 171        |
| Relubrication facilities .....  | 171        |
| <b>Product tables .....</b>   | <b>172</b> |
| 6.1 Rod ends with a female thread, steel/steel .....                          | 172        |
| 6.2 Rod ends with a female thread, for hydraulic cylinders, steel/steel ..... | 174        |
| 6.3 Rod ends with a male thread, steel/steel .....                            | 178        |
| 6.4 Rod ends with a cylindrical section welding shank, steel/steel .....      | 180        |
| 6.5 Rod ends with a rectangular section welding shank, steel/steel .....      | 182        |
| 6.6 Rod ends with a female thread, steel/bronze .....                         | 184        |
| 6.7 Rod ends with a male thread, steel/bronze .....                           | 186        |

## Rod ends requiring maintenance

SKF manufactures rod ends requiring maintenance with a steel/steel or a steel/bronze sliding contact surface combination.

Steel/steel rod ends consist of a rod end housing and a steel/steel radial spherical plain bearing from the standard assortment, where the outer ring is secured in the housing. These rod ends are available with a female thread (→ **fig. 1**), male thread (→ **fig. 2**) or a welding shank (→ **fig. 3**).

Steel/bronze rod ends consist of a rod end housing and a steel/bronze spherical plain bearing. These bearings have an inner ring made of steel and an outer ring made of bronze. The bearing is held in position by staking the housing on both sides of the outer ring. These rod ends are available with a male or female thread.

SKF supplies rod ends with a threaded shank with a right-hand thread as standard. With the exception of rod ends with the designation suffix VZ019, all rod ends are also available with a left-hand thread. They are identified by the designation prefix L.

## Dimensions

The dimensions of SKF rod ends requiring maintenance are in accordance with the standards listed in **table 1**.

Male and female threads of SKF rod ends are in accordance with ISO 965-1:1998, except for rod ends with female thread having the designation suffix /VZ019, which is in accordance with ISO 8139:2009.

## Tolerances

SKF rod end inner ring dimensional tolerances are in accordance with ISO 12240-4:1998. The tolerances for the steel/steel rod end inner rings are listed in **table 3** and the tolerances for steel/bronze rod end inner rings are listed in **table 2**.

The symbols used in these tables are explained in the following:

- d nominal bore diameter
- $\Delta_{dmp}$  deviation of the mean bore diameter from the nominal
- $\Delta_{Bs}$  deviation of the single inner ring width from the nominal

Fig. 1

Rod end with a female thread

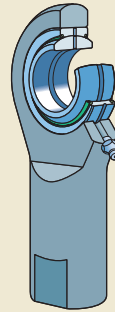

Fig. 2

Rod end with a male thread

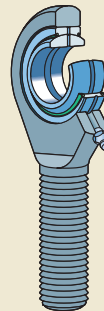
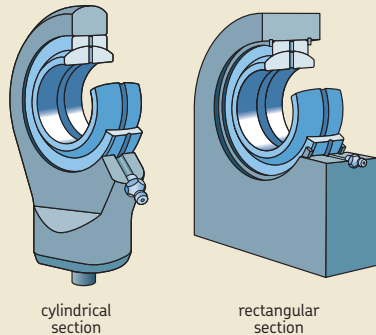

Fig. 3

Rod ends with a welding shank



## Radial internal clearance

The clearance values for steel/steel rod ends are in accordance with dimension series E and EH of ISO 12240-4:1998, as far as they have been standardized. The values are listed in **table 4** on **page 170**.

The clearance values for steel/bronze rod ends are in accordance with dimensions series K of ISO 12240-4:1998 and are listed in **table 5** on **page 170**.

## Materials

SKF rod end housings for bearings that require maintenance are made of the materials listed in **table 6** on **page 170**.

The materials used for steel/steel radial spherical plain bearings incorporated in SKF rod ends are provided in the section *Materials* on **page 102**.

The bearings incorporated in the steel/bronze rod ends have an outer ring made of bronze and an inner ring made of bearing steel which has been hardened and ground.

Table 1

| Standards                     |   |
|-------------------------------|---|
| Series                        | Standards   |
| SA(A)<br>SI(A)                | ISO 12240-4:1998 dimension series E, EH<br>ISO 12240-4:1998 dimension series E, EH                            |
| SC<br>SCF                     | ISO 12240-4:1998 dimension series E<br>–  |
| SIJ<br>SIR<br>SIQG            | ISO 8133:2006<br>–<br>ISO 8132:2006   |
| SAKAC<br>SIKAC<br>SIKAC/VZ019 | ISO 12240-4:1998 dimension series K<br>ISO 12240-4:1998 dimension series K<br>ISO 8139:2009, ISO 12240-4:1998 |

Table 2

### Inner ring dimensional tolerances for steel/bronze rod ends

| Bore diameter<br>d<br>over incl. |           | SIKAC and SAKAC series |     |                       |      |
|----------------------------------|-----------|------------------------|-----|-----------------------|------|
|                                  |           | $\Delta_{dmp}$<br>high | low | $\Delta_{Bs}$<br>high | low  |
| mm                               |           | $\mu\text{m}$          |     | $\mu\text{m}$         |      |
| –                                | <b>6</b>  | 12                     | 0   | 0                     | –120 |
| <b>6</b>                         | <b>10</b> | 15                     | 0   | 0                     | –120 |
| <b>10</b>                        | <b>18</b> | 18                     | 0   | 0                     | –120 |
| <b>18</b>                        | <b>30</b> | 21                     | 0   | 0                     | –120 |

Table 3

### Inner ring dimensional tolerances for steel/steel rod ends

| Bore diameter<br>d<br>over incl. |            | SA(A), SI(A), SIJ, SIR,<br>SC and SCF series |     |                       |      | SIQG series            |     |                       |      |
|----------------------------------|------------|--|-----|-----------------------|------|------------------------|-----|-----------------------|------|
|                                  |            | $\Delta_{dmp}$<br>high                       | low | $\Delta_{Bs}$<br>high | low  | $\Delta_{dmp}$<br>high | low | $\Delta_{Bs}$<br>high | low  |
| mm                               |            | $\mu\text{m}$                                |     |                       |      | $\mu\text{m}$          |     |                       |      |
| –                                | <b>10</b>  | 0  | –8  | 0                     | –120 | –                      | –   | –                     | –    |
| <b>10</b>                        | <b>18</b>  | 0  | –8  | 0                     | –120 | 18                     | 0   | 0                     | –180 |
| <b>18</b>                        | <b>30</b>  | 0  | –10 | 0                     | –120 | 21                     | 0   | 0                     | –210 |
| <b>30</b>                        | <b>50</b>  | 0  | –12 | 0                     | –120 | 25                     | 0   | 0                     | –250 |
| <b>50</b>                        | <b>80</b>  | 0  | –15 | 0                     | –150 | 30                     | 0   | 0                     | –300 |
| <b>80</b>                        | <b>120</b> | 0  | –20 | 0                     | –200 | 35                     | 0   | 0                     | –350 |
| <b>120</b>                       | <b>180</b> | 0  | –25 | 0                     | –250 | 40                     | 0   | 0                     | –400 |
| <b>180</b>                       | <b>250</b> | 0  | –30 | 0                     | –300 | 46                     | 0   | 0                     | –460 |

## Rod ends requiring maintenance

### Permissible operating temperature range

The permissible operating temperature range for SKF rod ends requiring maintenance depends on the rod end housing, the bearing, the bearing seals and the grease used for lubrication. The values for the permissible operating temperature range are listed in **table 7**.

The load carrying capacity of the rod end is reduced at temperatures above 100 °C. For temperatures below 0 °C, check to be sure that the fracture toughness of the rod end housing is adequate for the intended application.

Table 4

#### Radial internal clearance for steel/steel rod ends

| Bore diameter d |       | Radial internal clearance |     |
|-----------------|-------|---------------------------|-----|
| over            | incl. | Normal min                | max |
| mm              |       | µm                        |     |
| –               | 12    | 16                        | 68  |
| 12              | 20    | 20                        | 82  |
| 20              | 35    | 25                        | 100 |
| 35              | 60    | 30                        | 120 |
| 60              | 90    | 36                        | 142 |
| 90              | 140   | 42                        | 165 |
| 140             | 240   | 50                        | 192 |

Table 5

#### Radial internal clearance for steel/bronze rod ends

| Bore diameter d |       | Radial internal clearance |     |
|-----------------|-------|---------------------------|-----|
| over            | incl. | Normal min                | max |
| mm              |       | µm                        |     |
| –               | 6     | 5                         | 50  |
| 6               | 10    | 7                         | 61  |
| 10              | 18    | 8                         | 75  |
| 18              | 30    | 10                        | 92  |

Table 6

#### Housing materials for rod ends requiring maintenance

| Series | Size                  | Material  | Material No. |
|--------|-----------------------|---|--------------|
| SA(A)  | 6 to 80               | Heat treatable steel C45V zinc coated and chromatinized         | 1.0503       |
| SI(A)  | 6 to 80               | Heat treatable steel C45V zinc coated and chromatinized         | 1.0503       |
| SC     | 20 to 80              | Construction steel S 355 J2G3 (St 52-3 N)                       | 1.0570       |
| SCF    | 20 to 80              | Construction steel S 355 J2G3 (St 52-3 N)                       | 1.0570       |
| SIQG   | 12 to 63<br>70 to 200 | Heat treatable steel C45<br>EN-GJS-400-15                       | 1.0503<br>–  |
| SIJ    | 12 to 50              | Heat treatable steel C45  | 1.0503       |
| SIR    | 60 to 100             | EN-GJS-400-15   | –            |
|        | 25 to 80<br>90 to 120 | Heat treatable steel C45<br>EN-GJS-400-15                       | 1.0503<br>–  |
| SAKAC  | 5 to 12               | Free-machining steel 9 SMnPb 28 K zinc coated and chromatinized | 1.0718       |
|        | 14 to 30              | Heat treatable steel C35N zinc coated and chromatinized         | 1.0501       |
| SIKAC  | 5 to 12               | Free-machining steel 9 SMnPb 28 K zinc coated and chromatinized | 1.0718       |
|        | 14 to 30              | Heat treatable steel C35N zinc coated and chromatinized         | 1.0501       |

SKF reserves the right to use similar material or material of higher strength.

## Fatigue strength

In all applications where a rod end is subjected to alternating loads, loads that vary in magnitude or where failure of a rod end is dangerous, make sure that the selected rod end has sufficient fatigue strength.

## Relubrication facilities

SKF rod ends requiring maintenance are provided with a grease fitting or a lubrication hole in the rod end housing. Relubrication via the pin is also possible. Exceptions are steel/steel rod ends in the SA .. E and SI .. E series and a few smaller rod ends as indicated in the product tables. The type and design of relubrication facilities in the rod end housing are listed in **table 8**.

Table 7



### Permissible operating temperature range for rod ends requiring maintenance

| Series                       | Permissible operating temperature range <sup>1)</sup> |       |
|------------------------------|---|-------|
|                              | from  | incl. |
| —                            | °C  |       |
| <b>Steel/steel rod ends</b>  |   |       |
| SA .. E(S)                   | -50   | +200  |
| SA(A) .. ES-2RS              | -30   | +130  |
| SI .. E(S)                   | -50   | +200  |
| SI(A) .. ES-2RS              | -30   | +130  |
| SIQG .. ES                   | -50   | +200  |
| SIJ .. ES                    | -50   | +200  |
| SIR .. ES                    | -50   | +200  |
| SC(F) .. ES                  | -50   | +200  |
| <b>Steel/bronze rod ends</b> |   |       |
| SAKAC .. M                   | -30   | +180  |
| SIKAC .. M (VZ 019)          | -30   | +180  |

<sup>1)</sup> Permissible operating temperature range of the grease must be considered.

Table 8

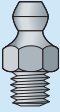
### Relubrication facilities for rod ends requiring maintenance

| Series                       | Size      | Relubrication facilities Design                   |   |
|------------------------------|-----------|---|---|
| <b>Steel/steel rod ends</b>  |           |   |   |
| SA .. ES                     | 15 to 20  | Lubrication hole diameter 2,5 mm                  |  |
| SI .. ES                     | 15 to 20  |   |   |
| SI .. ES                     | 15 to 20  |   |   |
| SIJ .. ES                    | 16 to 20  |   |   |
| SC .. ES                     | 20        |   |   |
| SA(A) .. ES(-2RS)            | 25 to 80  | Grease fitting in accordance with DIN 71412: 1987 |  |
| SI(A) .. ES(-2RS)            | 25 to 80  |   |   |
| SIJ .. ES                    | 25 to 100 |   |   |
| SIR .. ES                    | 25 to 120 |   |   |
| SIQG .. ES(A)                | 12 to 200 |   |   |
| SC .. ES                     | 25 to 80  |   |   |
| SCF .. ES                    | 20 to 80  |   |   |
| <b>Steel/bronze rod ends</b> |           |   |   |
| SAKAC .. M                   | 6 to 30   | Grease fitting in accordance with DIN 3405: 1986  |  |
| SIKAC .. M (VZ 019)          | 6 to 30   |   |   |

**Rod ends with a female thread, steel/steel**  
**d 6 – 80 mm**

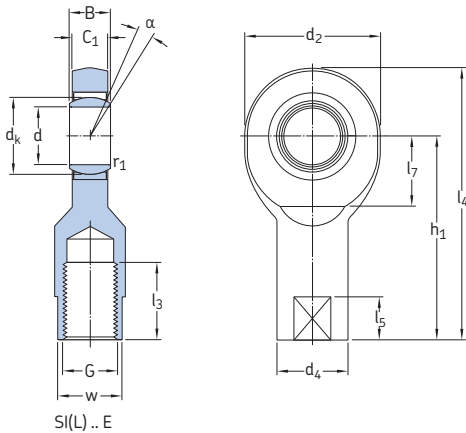

| Principal dimensions |                    |          |    | Angle of tilt | Basic load ratings |                | Mass | Designations |        |                                |                        |
|----------------------|--------------------|----------|----|---------------|--------------------|----------------|------|--------------|--------|--------------------------------|------------------------|
| d                    | d <sub>2</sub> max | G 6H     | B  |               | C <sub>1</sub> max | h <sub>1</sub> |      | dynamic      | static | Rod end with right-hand thread | left-hand thread       |
| mm                   |                    |          |    |               |                    | degrees        | kN   | kg           | –      |                                |                        |
| 6                    | 22                 | M 6      | 6  | 4,5           | 30                 | 13             | 3,4  | 8,15         | 0,023  | SI 6 E <sup>1)</sup>           | SIL 6 E <sup>1)</sup>  |
| 8                    | 25                 | M 8      | 8  | 6,5           | 36                 | 15             | 5,5  | 12,9         | 0,036  | SI 8 E <sup>1)</sup>           | SIL 8 E <sup>1)</sup>  |
| 10                   | 30                 | M 10     | 9  | 7,5           | 43                 | 12             | 8,15 | 19           | 0,065  | SI 10 E <sup>1)</sup>          | SIL 10 E <sup>1)</sup> |
| 12                   | 35                 | M 12     | 10 | 8,5           | 50                 | 10             | 10,8 | 25,5         | 0,11   | SI 12 E <sup>1)</sup>          | SIL 12 E <sup>1)</sup> |
| 15                   | 41                 | M 14     | 12 | 10,5          | 61                 | 8              | 17   | 37,5         | 0,18   | SI 15 ES                       | SIL 15 ES              |
| 17                   | 47                 | M 16     | 14 | 11,5          | 67                 | 10             | 21,2 | 44           | 0,25   | SI 17 ES                       | SIL 17 ES              |
| 20                   | 54                 | M 20×1,5 | 16 | 13,5          | 77                 | 9              | 30   | 57           | 0,36   | SI 20 ES                       | SIL 20 ES              |
| 25                   | 65                 | M 24×2   | 20 | 18            | 94                 | 7              | 48   | 90           | 0,65   | SI 25 ES                       | SIL 25 ES              |
| 30                   | 75                 | M 30×2   | 22 | 20            | 110                | 6              | 62   | 116          | 1,00   | SI 30 ES                       | SIL 30 ES              |
| 35                   | 84                 | M 36×3   | 25 | 22            | 130                | 6              | 80   | 134          | 1,40   | SI 35 ES-2RS                   | SIL 35 ES-2RS          |
| 40                   | 94                 | M 39×3   | 28 | 24            | 142                | 6              | 100  | 166          | 2,20   | SIA 40 ES-2RS                  | SILA 40 ES-2RS         |
|                      | 94                 | M 42×3   | 28 | 24            | 145                | 6              | 100  | 166          | 2,30   | SI 40 ES-2RS                   | SIL 40 ES-2RS          |
| 45                   | 104                | M 42×3   | 32 | 28            | 145                | 7              | 127  | 224          | 2,90   | SIA 45 ES-2RS                  | SILA 45 ES-2RS         |
|                      | 104                | M 45×3   | 32 | 28            | 165                | 7              | 127  | 224          | 3,20   | SI 45 ES-2RS                   | SIL 45 ES-2RS          |
| 50                   | 114                | M 45×3   | 35 | 31            | 160                | 6              | 156  | 270          | 4,10   | SIA 50 ES-2RS                  | SILA 50 ES-2RS         |
|                      | 114                | M 52×3   | 35 | 31            | 195                | 6              | 156  | 270          | 4,50   | SI 50 ES-2RS                   | SIL 50 ES-2RS          |
| 60                   | 137                | M 52×3   | 44 | 39            | 175                | 6              | 245  | 400          | 6,30   | SIA 60 ES-2RS                  | SILA 60 ES-2RS         |
|                      | 137                | M 60×4   | 44 | 39            | 225                | 6              | 245  | 400          | 7,10   | SI 60 ES-2RS                   | SIL 60 ES-2RS          |
| 70                   | 162                | M 56×4   | 49 | 43            | 200                | 6              | 315  | 530          | 9,50   | SIA 70 ES-2RS                  | SILA 70 ES-2RS         |
|                      | 162                | M 72×4   | 49 | 43            | 265                | 6              | 315  | 530          | 10,5   | SI 70 ES-2RS                   | SIL 70 ES-2RS          |
| 80                   | 182                | M 64×4   | 55 | 48            | 230                | 5              | 400  | 655          | 15,0   | SIA 80 ES-2RS                  | SILA 80 ES-2RS         |
|                      | 182                | M 80×4   | 55 | 48            | 295                | 5              | 400  | 655          | 19,0   | SI 80 ES-2RS                   | SIL 80 ES-2RS          |

<sup>1)</sup> No relubrication facilities.

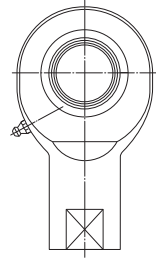
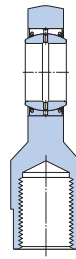
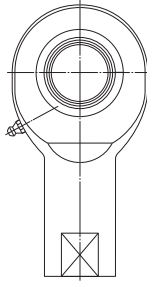
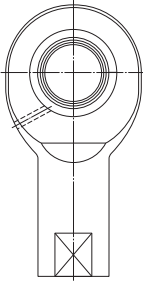
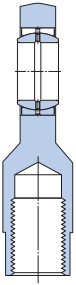

SI(L).. ES

$d \leq 20 \text{ mm}$

$d \geq 25 \text{ mm}$

SI(L).. ES-2RS  
SI(L).. ES-2RS

### Dimensions

| d  | $d_k$ | $d_4$<br>≈ | $l_3$<br>min | $l_4$<br>max | $l_5$<br>≈ | $l_7$<br>min | $r_1$<br>min | w<br>h14 |
|----|-------|------------|--------------|--------------|------------|--------------|--------------|----------|
| mm |       |            |              |              |            |              |              |          |
| 6  | 10    | 11         | 11           | 43           | 8          | 10           | 0,3          | 9        |
| 8  | 13    | 13         | 15           | 50           | 9          | 11           | 0,3          | 11       |
| 10 | 16    | 16         | 15           | 60           | 11         | 13           | 0,3          | 14       |
| 12 | 18    | 19         | 18           | 69           | 12         | 17           | 0,3          | 17       |
| 15 | 22    | 22         | 21           | 83           | 14         | 19           | 0,3          | 19       |
| 17 | 25    | 25         | 24           | 92           | 15         | 22           | 0,3          | 22       |
| 20 | 29    | 28         | 30           | 106          | 16         | 24           | 0,3          | 24       |
| 25 | 35,5  | 35         | 36           | 128          | 18         | 30           | 0,6          | 30       |
| 30 | 40,7  | 42         | 45           | 149          | 19         | 34           | 0,6          | 36       |
| 35 | 47    | 49         | 60           | 174          | 25         | 40           | 0,6          | 41       |
| 40 | 53    | 58         | 65           | 191          | 25         | 46           | 0,6          | 50       |
|    | 53    | 58         | 65           | 194          | 25         | 46           | 0,6          | 50       |
| 45 | 60    | 65         | 65           | 199          | 30         | 50           | 0,6          | 55       |
|    | 60    | 65         | 65           | 219          | 30         | 50           | 0,6          | 55       |
| 50 | 66    | 70         | 68           | 219          | 30         | 58           | 0,6          | 60       |
|    | 66    | 70         | 68           | 254          | 30         | 58           | 0,6          | 60       |
| 60 | 80    | 82         | 70           | 246          | 35         | 73           | 1            | 70       |
|    | 80    | 82         | 70           | 296          | 35         | 73           | 1            | 70       |
| 70 | 92    | 92         | 80           | 284          | 40         | 85           | 1            | 80       |
|    | 92    | 92         | 80           | 349          | 40         | 85           | 1            | 80       |
| 80 | 105   | 105        | 85           | 324          | 45         | 98           | 1            | 90       |
|    | 105   | 105        | 85           | 389          | 45         | 98           | 1            | 90       |

**Rod ends with a female thread, for hydraulic cylinders, steel/steel**  
**d 12 – 70 mm**

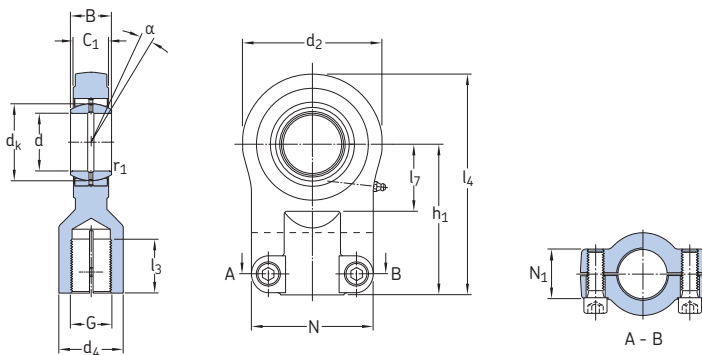

SI(LJ) .. ES

| Principal dimensions |                    |           |    |                    | Angle of tilt  | Basic load ratings |      | Mass           | Designations                   |                                |                            |
|----------------------|--------------------|-----------|----|--------------------|----------------|--------------------|------|----------------|--------------------------------|--------------------------------|----------------------------|
| d                    | d <sub>2</sub> max | G 6H      | B  | C <sub>1</sub> max | h <sub>1</sub> | α                  | C    | C <sub>0</sub> | Rod end with right-hand thread | left-hand thread <sup>1)</sup> |                            |
|                      |                    |           |    |                    |                | degrees            | kN   |                | kg                             | -                              |                            |
| 12                   | 36                 | M 10×1,25 | 10 | 8                  | 42             | 3                  | 10,8 | 21,2           | 0,14                           | SIJ 12 E <sup>2)</sup>         | SILJ 12 E <sup>2)</sup>    |
|                      | 33                 | M 12×1,25 | 12 | 11                 | 38             | 4                  | 10,8 | 22             | 0,11                           | SIQG 12 ESA <sup>3)</sup>      | SILQG 12 ESA <sup>3)</sup> |
| 16                   | 45                 | M 12×1,25 | 14 | 11                 | 48             | 3                  | 21,2 | 23,5           | 0,25                           | SIJ 16 ES                      | SILJ 16 ES                 |
|                      | 41                 | M 14×1,5  | 16 | 14                 | 44             | 4                  | 17,6 | 32,5           | 0,21                           | SIQG 16 ES                     | SILQG 16 ES                |
| 20                   | 55                 | M 14×1,5  | 16 | 13                 | 58             | 3                  | 30   | 51             | 0,40                           | SIJ 20 ES                      | SILJ 20 ES                 |
|                      | 48                 | M 16×1,5  | 20 | 17,5               | 52             | 4                  | 30   | 43             | 0,40                           | SIQG 20 ES                     | SILQG 20 ES                |
| 25                   | 65                 | M 16×1,5  | 20 | 17                 | 68             | 3                  | 48   | 73,5           | 0,68                           | SIJ 25 ES                      | SILJ 25 ES                 |
|                      | 57                 | M 16×1,5  | 20 | 23,5               | 50             | 7                  | 48   | 52             | 0,49                           | SIR 25 ES                      | SILR 25 ES                 |
|                      | 59                 | M 20×1,5  | 25 | 22                 | 65             | 4                  | 48   | 69,5           | 0,66                           | SIQG 25 ES                     | SILQG 25 ES                |
| 30                   | 80                 | M 20×1,5  | 22 | 19                 | 85             | 3                  | 62   | 112            | 1,35                           | SIJ 30 ES                      | SILJ 30 ES                 |
|                      | 65                 | M 22×1,5  | 22 | 28,5               | 60             | 6                  | 62   | 78             | 0,77                           | SIR 30 ES                      | SILR 30 ES                 |
| 32                   | 71                 | M 27×2    | 32 | 28                 | 80             | 4                  | 65,5 | 100            | 1,20                           | SIQG 32 ES                     | SILQG 32 ES                |
| 35                   | 79                 | M 28×1,5  | 25 | 30,5               | 70             | 6                  | 80   | 118            | 1,20                           | SIR 35 ES                      | SILR 35 ES                 |
| 40                   | 98                 | M 27×2    | 28 | 23                 | 105            | 3                  | 100  | 146            | 2,40                           | SIJ 40 ES                      | SILJ 40 ES                 |
|                      | 95                 | M 35×1,5  | 28 | 35,5               | 85             | 7                  | 100  | 200            | 2,10                           | SIR 40 ES                      | SILR 40 ES                 |
|                      | 90                 | M 33×2    | 40 | 34                 | 97             | 4                  | 100  | 176            | 2,00                           | SIQG 40 ES                     | SILQG 40 ES                |
| 50                   | 122                | M 33×2    | 35 | 30                 | 130            | 3                  | 156  | 216            | 3,80                           | SIJ 50 ES                      | SILJ 50 ES                 |
|                      | 118                | M 45×1,5  | 35 | 40,5               | 105            | 6                  | 156  | 280            | 3,60                           | SIR 50 ES                      | SILR 50 ES                 |
|                      | 110                | M 42×2    | 50 | 42                 | 120            | 4                  | 156  | 270            | 3,50                           | SIQG 50 ES                     | SILQG 50 ES                |
| 60                   | 160                | M 42×2    | 44 | 38                 | 150            | 3                  | 245  | 405            | 8,50                           | SIJ 60 ES                      | SILJ 60 ES                 |
|                      | 132                | M 58×1,5  | 44 | 50,5               | 130            | 6                  | 245  | 325            | 6,00                           | SIR 60 ES                      | SILR 60 ES                 |
| 63                   | 134                | M 48×2    | 63 | 53,5               | 140            | 4                  | 255  | 375            | 6,80                           | SIQG 63 ES                     | SILQG 63 ES                |
| 70                   | 156                | M 65×1,5  | 49 | 55,5               | 150            | 6                  | 315  | 450            | 9,40                           | SIR 70 ES                      | SILR 70 ES                 |

<sup>1)</sup> Check availability of rod ends with left-hand thread.

<sup>2)</sup> No relubrication facilities.

<sup>3)</sup> Can only be relubricated via the outer ring.



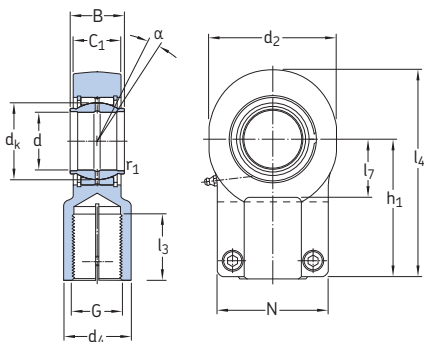

SI(L)QG..ES

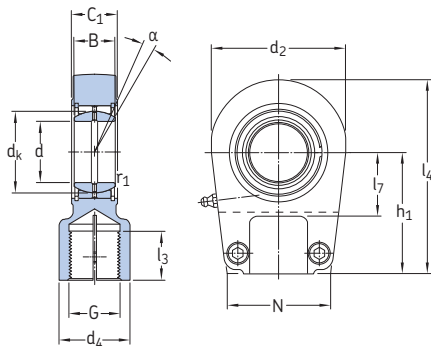

SI(L)R..ES

**Dimensions**

**Cylinder bolt with internal hexagon (ISO 4762:1998)**

| d  | dk   | d4 max | l3 min | l4 max | l7 min | N max | N1 max | r1 min | Size               | Tightening torque |
|----|------|--------|--------|--------|--------|-------|--------|--------|--------------------|-------------------|
| mm |      |        |        |        |        |       |        |        | -                  | Nm                |
| 12 | 18   | 17     | 15     | 62     | 16     | 40    | 13     | 0,3    | M 6                | 10                |
|    | 18   | 17     | 17     | 55     | 13     | 33    | 11     | 0,3    | M 5                | 5,5               |
| 16 | 25   | 21     | 17     | 70,5   | 20     | 45    | 13     | 0,3    | M 6                | 10                |
|    | 23   | 22     | 19     | 64,5   | 17     | 41    | 14     | 0,3    | M 6                | 9,5               |
| 20 | 29   | 25     | 19     | 85,5   | 25     | 55    | 17     | 0,3    | M 8                | 25                |
|    | 29   | 26,5   | 23     | 77     | 21     | 48    | 18     | 0,3    | M 8                | 23                |
| 25 | 35,5 | 30     | 23     | 100,5  | 30     | 62    | 17     | 0,6    | M 8                | 25                |
|    | 35,5 | 26     | 17     | 79,5   | 27     | 42    | 23,5   | 0,6    | M 8                | 25                |
|    | 35,5 | 31     | 29     | 97     | 26     | 55    | 18     | 0,6    | M 8                | 23                |
| 30 | 40,7 | 36     | 29     | 125    | 35     | 80    | 19     | 0,6    | M 10               | 45                |
|    | 40,7 | 33     | 23     | 93,5   | 29     | 47    | 28,5   | 0,6    | M 8                | 23                |
| 32 | 43   | 38     | 37     | 116,5  | 31     | 67    | 23     | 0,6    | M 10               | 46                |
| 35 | 47   | 41,5   | 29     | 110,5  | 37     | 59    | 30,5   | 0,6    | M 10               | 46                |
| 40 | 53   | 45     | 37     | 155    | 45     | 90    | 23     | 0,6    | M 10               | 45                |
|    | 53   | 50,5   | 36     | 133,5  | 44     | 67    | 35,5   | 0,6    | M 10               | 46                |
|    | 53   | 47     | 46     | 143    | 40     | 81    | 28     | 0,6    | M 10               | 46                |
| 50 | 66   | 55     | 46     | 192,5  | 58     | 105   | 30     | 0,6    | M 12               | 80                |
|    | 66   | 62,5   | 46     | 164,5  | 54     | 89    | 40,5   | 0,6    | M 12 <sup>1)</sup> | 79 <sup>1)</sup>  |
|    | 66   | 58     | 57     | 175,5  | 49     | 97,5  | 33     | 0,6    | M 12               | 79                |
| 60 | 80   | 68     | 57     | 230    | 68     | 134   | 38     | 1      | M 16               | 160               |
|    | 80   | 76,5   | 59     | 202,5  | 64     | 91    | 50,5   | 1      | M 16 <sup>1)</sup> | 46 <sup>1)</sup>  |
| 63 | 83   | 70     | 64     | 213,5  | 61     | 116   | 40     | 1      | M 16 <sup>1)</sup> | 195 <sup>1)</sup> |
| 70 | 92   | 87,5   | 66     | 234,5  | 74     | 101   | 55,5   | 1      | M 16 <sup>1)</sup> | 79 <sup>1)</sup>  |

<sup>1)</sup> Bolts, position of bolts, and tightening torque may vary.

**Rod ends with a female thread, for hydraulic cylinders, steel/steel**  
**d 80 – 200 mm**

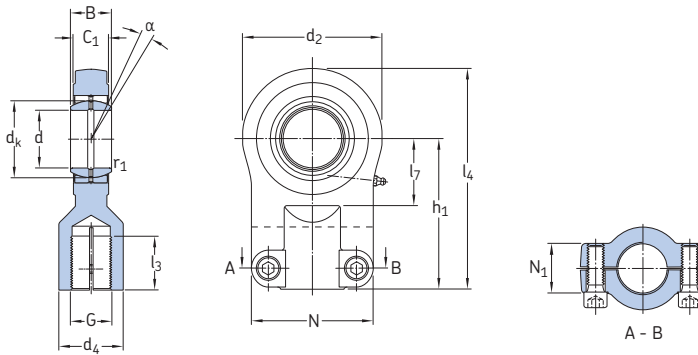

SI(LJ) .. ES

| Principal dimensions |                       |         |     |                       |                | Angle of tilt | Basic load ratings |                | Mass | Designations                         |                     |
|----------------------|-----------------------|---------|-----|-----------------------|----------------|---------------|--------------------|----------------|------|--------------------------------------|---------------------|
| d                    | d <sub>2</sub><br>max | G<br>6H | B   | C <sub>1</sub><br>max | h <sub>1</sub> | α             | C                  | C <sub>0</sub> |      | Rod end with<br>right-hand<br>thread | left-hand<br>thread |
| mm                   |                       |         |     |                       |                | degrees       | kN                 |                | kg   | –                                    |                     |
| <b>80</b>            | 205                   | M 48×2  | 55  | 47                    | 185            | 3             | 400                | 610            | 14,5 | <b>SIJ 80 ES</b>                     | <b>SILJ 80 ES</b>   |
|                      | 178                   | M 80×2  | 55  | 60,5                  | 170            | 6             | 400                | 560            | 13,0 | <b>SIR 80 ES</b>                     | <b>SILR 80 ES</b>   |
|                      | 170                   | M 64×3  | 80  | 68                    | 180            | 4             | 400                | 600            | 14,5 | <b>SIQG 80 ES</b>                    | <b>SILQG 80 ES</b>  |
| <b>100</b>           | 240                   | M 64×3  | 70  | 57                    | 240            | 3             | 610                | 780            | 29,5 | <b>SIJ 100 ES</b>                    | <b>SILJ 100 ES</b>  |
|                      | 232                   | M 110×2 | 70  | 70,5                  | 235            | 7             | 610                | 950            | 30,0 | <b>SIR 100 ES</b>                    | <b>SILR 100 ES</b>  |
|                      | 212                   | M 80×3  | 100 | 85,5                  | 210            | 4             | 610                | 930            | 28,0 | <b>SIQG 100 ES</b>                   | <b>SILQG 100 ES</b> |
| <b>120</b>           | 343                   | M 130×3 | 85  | 90,5                  | 310            | 6             | 950                | 2 450          | 84,0 | <b>SIR 120 ES</b>                    | <b>SILR 120 ES</b>  |
| <b>125</b>           | 268                   | M 100×3 | 125 | 105                   | 260            | 4             | 950                | 1 430          | 43,0 | <b>SIQG 125 ES</b>                   | <b>SILQG 125 ES</b> |
| <b>160</b>           | 328                   | M 125×4 | 160 | 133                   | 310            | 4             | 1 370              | 2 200          | 80,0 | <b>SIQG 160 ES</b>                   | <b>SILQG 160 ES</b> |
| <b>200</b>           | 420                   | M 160×4 | 200 | 165                   | 390            | 4             | 2 120              | 3 400          | 165  | <b>SIQG 200 ES</b>                   | <b>SILQG 200 ES</b> |

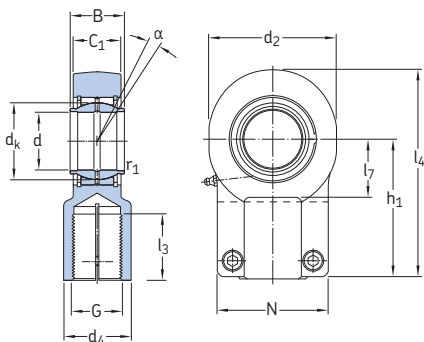

SI(L)QG..ES

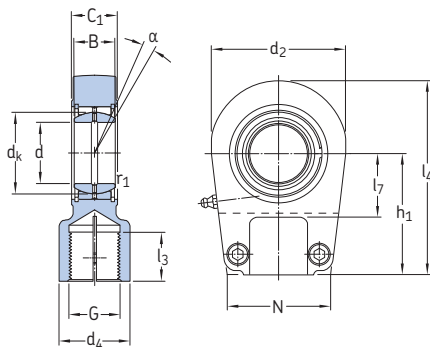

SI(L)R..ES

**Dimensions**

| d          | dk  | d4<br>max | l3<br>min | l4<br>max | l7<br>min | N<br>max | N1<br>max | r1<br>min | Cylinder bolt<br>with internal hexagon<br>(ISO 4762:1998) |                      |
|------------|-----|-----------|-----------|-----------|-----------|----------|-----------|-----------|---|----------------------|
|            |     |           |           |           |           |          |           |           | Size  | Tightening<br>torque |
| mm         |     |           |           |           |           |          |           |           | -   | Nm                   |
| <b>80</b>  | 105 | 90        | 64        | 287,5     | 92        | 156      | 47        | 1         | M 20  | 310                  |
|            | 105 | 103,5     | 81        | 267,5     | 79        | 126      | 60,5      | 1         | M 20 <sup>1)</sup>  | 195 <sup>1)</sup>    |
|            | 105 | 91        | 86        | 272,5     | 77        | 150      | 50        | 1         | M 20 <sup>1)</sup>  | 390 <sup>1)</sup>    |
| <b>100</b> | 130 | 110       | 86        | 360       | 116       | 190      | 57        | 1         | M 24  | 530                  |
|            | 130 | 140       | 111       | 362,5     | 103       | 167      | 70,5      | 1         | M 24 <sup>1)</sup>  | 390 <sup>1)</sup>    |
|            | 130 | 110       | 96        | 324       | 97        | 180      | 65        | 1         | M 24 <sup>1)</sup>  | 670 <sup>1)</sup>    |
| <b>120</b> | 160 | 175       | 135       | 493       | 138       | 257      | 86        | 1         | M 24 <sup>1)</sup>  | 670 <sup>1)</sup>    |
| <b>125</b> | 160 | 135       | 113       | 407       | 118       | 202      | 75        | 1         | M 24 <sup>1)</sup>  | 670 <sup>1)</sup>    |
| <b>160</b> | 200 | 165       | 126       | 490       | 148       | 252      | 85        | 1         | M 24 <sup>1)</sup>  | 670 <sup>1)</sup>    |
| <b>200</b> | 250 | 215       | 161       | 623       | 193       | 323      | 106       | 1,1       | M 30 <sup>1)</sup>  | 1 350 <sup>1)</sup>  |

<sup>1)</sup> Bolts, position of bolts, and tightening torque may vary.

**Rod ends with a male thread, steel/steel**  
**d 6 – 80 mm**

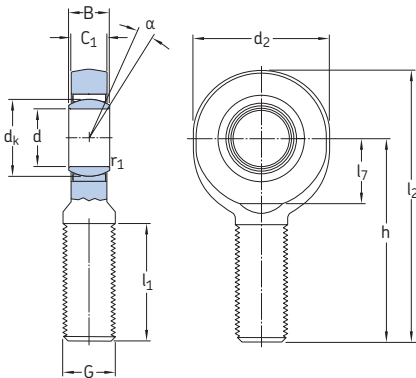

SA(L) .. E

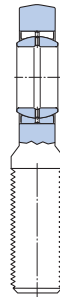

SA(L) .. ES

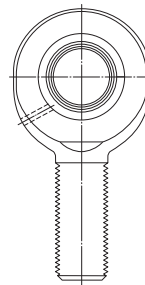

$d \leq 20 \text{ mm}$

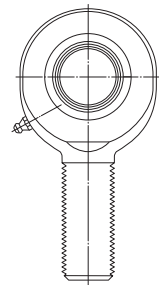

$d \geq 25 \text{ mm}$

| Principal dimensions |                       |          | Angle of tilt |                       | Basic load ratings |          | Mass | Designations |                |                                      |                        |
|----------------------|-----------------------|----------|---------------|-----------------------|--------------------|----------|------|--------------|----------------|--------------------------------------|------------------------|
| d                    | d <sub>2</sub><br>max | G<br>6g  | B             | C <sub>1</sub><br>max | h                  | $\alpha$ |      | C            | C <sub>0</sub> | Rod end with<br>right-hand<br>thread | left-hand<br>thread    |
| mm                   |                       |          | degrees       |                       | kN                 |          | kg   |              | -              |                                      |                        |
| 6                    | 22                    | M 6      | 6             | 4,5                   | 36                 | 13       | 3,4  | 8,15         | 0,017          | SA 6 E <sup>1)</sup>                 | SAL 6 E <sup>1)</sup>  |
| 8                    | 25                    | M 8      | 8             | 6,5                   | 42                 | 15       | 5,5  | 12,9         | 0,029          | SA 8 E <sup>1)</sup>                 | SAL 8 E <sup>1)</sup>  |
| 10                   | 30                    | M 10     | 9             | 7,5                   | 48                 | 12       | 8,15 | 18,3         | 0,053          | SA 10 E <sup>1)</sup>                | SAL 10 E <sup>1)</sup> |
| 12                   | 35                    | M 12     | 10            | 8,5                   | 54                 | 10       | 10,8 | 24,5         | 0,078          | SA 12 E <sup>1)</sup>                | SAL 12 E <sup>1)</sup> |
| 15                   | 41                    | M 14     | 12            | 10,5                  | 63                 | 8        | 17   | 28           | 0,13           | SA 15 ES                             | SAL 15 ES              |
| 17                   | 47                    | M 16     | 14            | 11,5                  | 69                 | 10       | 21,2 | 31           | 0,19           | SA 17 ES                             | SAL 17 ES              |
| 20                   | 54                    | M 20x1,5 | 16            | 13,5                  | 78                 | 9        | 30   | 42,5         | 0,32           | SA 20 ES                             | SAL 20 ES              |
| 25                   | 65                    | M 24x2   | 20            | 18                    | 94                 | 7        | 48   | 78           | 0,53           | SA 25 ES                             | SAL 25 ES              |
| 30                   | 75                    | M 30x2   | 22            | 20                    | 110                | 6        | 62   | 81,5         | 0,90           | SA 30 ES                             | SAL 30 ES              |
| 35                   | 84                    | M 36x3   | 25            | 22                    | 130                | 6        | 80   | 110          | 1,30           | SA 35 ES-2RS                         | SAL 35 ES-2RS          |
| 40                   | 94                    | M 39x3   | 28            | 24                    | 150                | 6        | 100  | 140          | 1,85           | SAA 40 ES-2RS                        | SALA 40 ES-2RS         |
|                      | 94                    | M 42x3   | 28            | 24                    | 145                | 6        | 100  | 140          | 1,90           | SA 40 ES-2RS                         | SAL 40 ES-2RS          |
| 45                   | 104                   | M 42x3   | 32            | 28                    | 163                | 7        | 127  | 200          | 2,45           | SAA 45 ES-2RS                        | SALA 45 ES-2RS         |
|                      | 104                   | M 45x3   | 32            | 28                    | 165                | 7        | 127  | 200          | 2,55           | SA 45 ES-2RS                         | SAL 45 ES-2RS          |
| 50                   | 114                   | M 45x3   | 35            | 31                    | 185                | 6        | 156  | 245          | 3,30           | SAA 50 ES-2RS                        | SALA 50 ES-2RS         |
|                      | 114                   | M 52x3   | 35            | 31                    | 195                | 6        | 156  | 245          | 3,90           | SA 50 ES-2RS                         | SAL 50 ES-2RS          |
| 60                   | 137                   | M 52x3   | 44            | 39                    | 210                | 6        | 245  | 360          | 5,70           | SAA 60 ES-2RS                        | SALA 60 ES-2RS         |
|                      | 137                   | M 60x4   | 44            | 39                    | 225                | 6        | 245  | 360          | 6,25           | SA 60 ES-2RS                         | SAL 60 ES-2RS          |
| 70                   | 162                   | M 56x4   | 49            | 43                    | 235                | 6        | 315  | 490          | 7,90           | SAA 70 ES-2RS                        | SALA 70 ES-2RS         |
|                      | 162                   | M 72x4   | 49            | 43                    | 265                | 6        | 315  | 490          | 10,0           | SA 70 ES-2RS                         | SAL 70 ES-2RS          |
| 80                   | 182                   | M 64x4   | 55            | 48                    | 270                | 5        | 400  | 585          | 12,0           | SAA 80 ES-2RS                        | SALA 80 ES-2RS         |
|                      | 182                   | M 80x4   | 55            | 48                    | 295                | 5        | 400  | 585          | 14,5           | SA 80 ES-2RS                         | SAL 80 ES-2RS          |

<sup>1)</sup> No relubrication facilities.

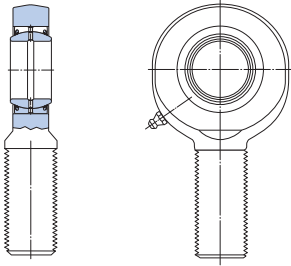

SA(L)A..ES-2RS

**Dimensions**

| d  | d <sub>k</sub> | l <sub>1</sub><br>min | l <sub>2</sub><br>max | l <sub>7</sub><br>min | r <sub>1</sub><br>min |
|----|----------------|-----------------------|-----------------------|-----------------------|-----------------------|
| mm |                |                       |                       |                       |                       |
| 6  | 10             | 16                    | 49                    | 10                    | 0,3                   |
| 8  | 13             | 21                    | 56                    | 11                    | 0,3                   |
| 10 | 16             | 26                    | 65                    | 13                    | 0,3                   |
| 12 | 18             | 28                    | 73                    | 17                    | 0,3                   |
| 15 | 22             | 34                    | 85                    | 19                    | 0,3                   |
| 17 | 25             | 36                    | 94                    | 22                    | 0,3                   |
| 20 | 29             | 43                    | 107                   | 24                    | 0,3                   |
| 25 | 35,5           | 53                    | 128                   | 30                    | 0,6                   |
| 30 | 40,7           | 65                    | 149                   | 34                    | 0,6                   |
| 35 | 47             | 82                    | 174                   | 40                    | 0,6                   |
| 40 | 53             | 86                    | 199                   | 46                    | 0,6                   |
|    | 53             | 90                    | 194                   | 46                    | 0,6                   |
| 45 | 60             | 92                    | 217                   | 50                    | 0,6                   |
|    | 60             | 95                    | 219                   | 50                    | 0,6                   |
| 50 | 66             | 104                   | 244                   | 58                    | 0,6                   |
|    | 66             | 110                   | 254                   | 58                    | 0,6                   |
| 60 | 80             | 115                   | 281                   | 73                    | 1                     |
|    | 80             | 120                   | 296                   | 73                    | 1                     |
| 70 | 92             | 125                   | 319                   | 85                    | 1                     |
|    | 92             | 132                   | 349                   | 85                    | 1                     |
| 80 | 105            | 140                   | 364                   | 98                    | 1                     |
|    | 105            | 147                   | 389                   | 98                    | 1                     |

**Rod ends with a cylindrical section welding shank, steel/steel**  
**d 20 – 80 mm**

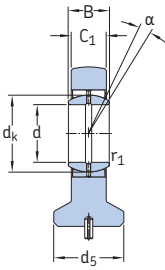

SC..ES

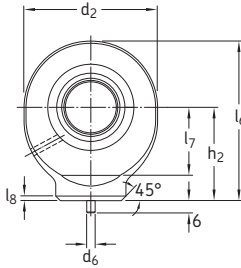

d = 20 mm

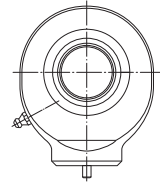

d ≥ 25 mm

| Principal dimensions |                    |    |                    |                | Angle of tilt | Basic load ratings<br>dynamic static |                | Mass | Designation |
|----------------------|--------------------|----|--------------------|----------------|---------------|--------------------------------------|----------------|------|-------------|
| d                    | d <sub>2 max</sub> | B  | C <sub>1 max</sub> | h <sub>2</sub> | α             | C                                    | C <sub>0</sub> |      |             |
| mm                   |                    |    |                    |                | degrees       | kN                                   |                | kg   | -           |
| 20                   | 54                 | 16 | 13,5               | 38             | 9             | 30                                   | 46,5           | 0,20 | SC 20 ES    |
| 25                   | 65                 | 20 | 18                 | 45             | 7             | 48                                   | 73,5           | 0,45 | SC 25 ES    |
| 30                   | 75                 | 22 | 20                 | 51             | 6             | 62                                   | 96,5           | 0,65 | SC 30 ES    |
| 35                   | 84                 | 25 | 22                 | 61             | 6             | 80                                   | 112            | 1,00 | SC 35 ES    |
| 40                   | 94                 | 28 | 24                 | 69             | 7             | 100                                  | 134            | 1,30 | SC 40 ES    |
| 45                   | 104                | 32 | 28                 | 77             | 7             | 127                                  | 180            | 1,90 | SC 45 ES    |
| 50                   | 114                | 35 | 31                 | 88             | 6             | 156                                  | 220            | 2,50 | SC 50 ES    |
| 60                   | 137                | 44 | 39                 | 100            | 6             | 245                                  | 335            | 4,60 | SC 60 ES    |
| 70                   | 162                | 49 | 43                 | 115            | 6             | 315                                  | 455            | 6,80 | SC 70 ES    |
| 80                   | 182                | 55 | 48                 | 141            | 6             | 400                                  | 550            | 9,70 | SC 80 ES    |

---

**Dimensions**

| d  | d <sub>k</sub> | d <sub>5</sub><br>max | d <sub>6</sub> | l <sub>6</sub><br>max | l <sub>7</sub><br>min | r <sub>1</sub><br>min | l <sub>8</sub> |
|----|----------------|-----------------------|----------------|-----------------------|-----------------------|-----------------------|----------------|
| mm |                |                       |                |                       |                       |                       |                |
| 20 | 29             | 29                    | 4              | 66                    | 24                    | 0,3                   | 2              |
| 25 | 35,5           | 35                    | 4              | 78                    | 30                    | 0,6                   | 3              |
| 30 | 40,7           | 42                    | 4              | 89                    | 34                    | 0,6                   | 3              |
| 35 | 47             | 49                    | 4              | 104                   | 40                    | 0,6                   | 3              |
| 40 | 53             | 54                    | 4              | 118                   | 46                    | 0,6                   | 4              |
| 45 | 60             | 60                    | 6              | 132                   | 50                    | 0,6                   | 4              |
| 50 | 66             | 64                    | 6              | 150                   | 58                    | 0,6                   | 4              |
| 60 | 80             | 72                    | 6              | 173                   | 73                    | 1                     | 4              |
| 70 | 92             | 82                    | 6              | 199                   | 85                    | 1                     | 5              |
| 80 | 105            | 97                    | 6              | 237                   | 98                    | 1                     | 5              |

**Rod ends with a rectangular section welding shank, steel/steel**  
**d 20 – 120 mm**

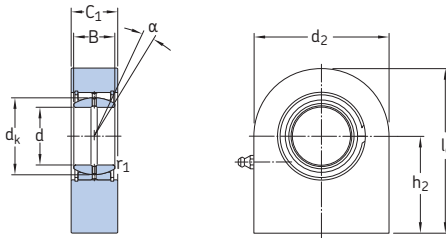

SCF .. ES

| Principal dimensions |                    |    |                    |                     | Angle of tilt | Basic load ratings |                | Mass | Designation |
|----------------------|--------------------|----|--------------------|---------------------|---------------|--------------------|----------------|------|-------------|
| d                    | d <sub>2 max</sub> | B  | C <sub>1 max</sub> | h <sub>2 js13</sub> | α             | C                  | C <sub>0</sub> |      |             |
| mm                   |                    |    |                    |                     | degrees       | kN                 |                | kg   | –           |
| 20                   | 51,5               | 16 | 20                 | 38                  | 9             | 30                 | 63             | 0,35 | SCF 20 ES   |
| 25                   | 56,5               | 20 | 24                 | 45                  | 7             | 48                 | 65,5           | 0,53 | SCF 25 ES   |
| 30                   | 66,5               | 22 | 29                 | 51                  | 6             | 62                 | 110            | 0,87 | SCF 30 ES   |
| 35                   | 85                 | 25 | 31                 | 61                  | 6             | 80                 | 183            | 1,55 | SCF 35 ES   |
| 40                   | 102                | 28 | 36,5               | 69                  | 7             | 100                | 285            | 2,45 | SCF 40 ES   |
| 45                   | 112                | 32 | 41,5               | 77                  | 7             | 127                | 360            | 3,40 | SCF 45 ES   |
| 50                   | 125,5              | 35 | 41,5               | 88                  | 6             | 156                | 415            | 4,45 | SCF 50 ES   |
| 60                   | 142,5              | 44 | 51,5               | 100                 | 6             | 245                | 530            | 7,00 | SCF 60 ES   |
| 70                   | 166,5              | 49 | 57                 | 115                 | 6             | 315                | 680            | 10,0 | SCF 70 ES   |
| 80                   | 182,5              | 55 | 62                 | 141                 | 6             | 400                | 750            | 15,0 | SCF 80 ES   |
| 90                   | 228,5              | 60 | 67                 | 150                 | 5             | 490                | 1 290          | 23,5 | SCF 90 ES   |
| 100                  | 252,5              | 70 | 72                 | 170                 | 7             | 610                | 1 430          | 31,5 | SCF 100 ES  |
| 110                  | 298                | 70 | 83                 | 185                 | 6             | 655                | 2 200          | 48,0 | SCF 110 ES  |
| 120                  | 363                | 85 | 92,5               | 210                 | 6             | 950                | 3 250          | 79,5 | SCF 120 ES  |



---

**Dimensions**

| d   | d <sub>k</sub> | l <sub>6</sub><br>max | r <sub>1</sub><br>min |
|-----|----------------|-----------------------|-----------------------|
| mm  |                |                       |                       |
| 20  | 29             | 64                    | 0,3                   |
| 25  | 35,5           | 73,5                  | 0,6                   |
| 30  | 40,7           | 85                    | 0,6                   |
| 35  | 47             | 103,5                 | 0,6                   |
| 40  | 53             | 120                   | 0,6                   |
| 45  | 60             | 133                   | 0,6                   |
| 50  | 66             | 151                   | 0,6                   |
| 60  | 80             | 171,5                 | 1                     |
| 70  | 92             | 198,5                 | 1                     |
| 80  | 105            | 232,5                 | 1                     |
| 90  | 115            | 264,5                 | 1                     |
| 100 | 130            | 296,5                 | 1                     |
| 110 | 140            | 334                   | 1                     |
| 120 | 160            | 391,5                 | 1                     |

**Rod ends with a female thread, steel/bronze**  
**d 5 – 30 mm**

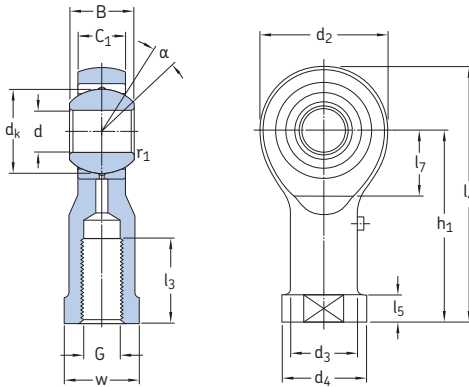

Si(L)KAC.. M/(VZ019)  
d ≥ 6 mm

| Principal dimensions |                       |           |    | Angle of tilt         |                | Basic load ratings |      | Mass           | Designations |                                |                          |
|----------------------|-----------------------|-----------|----|-----------------------|----------------|--------------------|------|----------------|--------------|--------------------------------|--------------------------|
| d                    | d <sub>2</sub><br>max | G<br>6H   | B  | C <sub>1</sub><br>max | h <sub>1</sub> | α                  | C    | C <sub>0</sub> |              | Rod end with right-hand thread | left-hand thread         |
| mm                   |                       |           |    |                       |                | degrees            | kN   |                | kg           | –                              |                          |
| 5                    | 19                    | M 5       | 8  | 7,5                   | 27             | 13                 | 3,25 | 5,4            | 0,017        | SIKAC 5 M <sup>1)</sup>        | SILKAC 5 M <sup>1)</sup> |
|                      | 19                    | M 4       | 8  | 7,5                   | 27             | 13                 | 3,25 | 5,4            | 0,017        | SIKAC 5 M/VZ019 <sup>1)</sup>  | –                        |
| 6                    | 21                    | M 6       | 9  | 7,5                   | 30             | 13                 | 4,3  | 5,4            | 0,025        | SIKAC 6 M                      | SILKAC 6 M               |
| 8                    | 25                    | M 8       | 12 | 9,5                   | 36             | 14                 | 7,2  | 9,15           | 0,043        | SIKAC 8 M                      | SILKAC 8 M               |
| 10                   | 29                    | M 10      | 14 | 11,5                  | 43             | 13                 | 10   | 12,2           | 0,072        | SIKAC 10 M                     | SILKAC 10 M              |
|                      | 29                    | M 10×1,25 | 14 | 11,5                  | 43             | 13                 | 10   | 12,2           | 0,072        | SIKAC 10 M/VZ019               | –                        |
| 12                   | 33                    | M 12      | 16 | 12,5                  | 50             | 13                 | 13,4 | 14             | 0,11         | SIKAC 12 M                     | SILKAC 12 M              |
|                      | 33                    | M 12×1,25 | 16 | 12,5                  | 50             | 13                 | 13,4 | 14             | 0,11         | SIKAC 12 M/VZ019               | –                        |
| 14                   | 37                    | M 14      | 19 | 14,5                  | 57             | 16                 | 17   | 20,4           | 0,16         | SIKAC 14 M                     | SILKAC 14 M              |
| 16                   | 43                    | M 16      | 21 | 15,5                  | 64             | 15                 | 21,6 | 29             | 0,22         | SIKAC 16 M                     | SILKAC 16 M              |
|                      | 43                    | M 16×1,5  | 21 | 15,5                  | 64             | 15                 | 21,6 | 29             | 0,22         | SIKAC 16 M/VZ019               | –                        |
| 18                   | 47                    | M 18×1,5  | 23 | 17,5                  | 71             | 15                 | 26   | 35,5           | 0,30         | SIKAC 18 M                     | SILKAC 18 M              |
| 20                   | 51                    | M 20×1,5  | 25 | 18,5                  | 77             | 14                 | 31,5 | 35,5           | 0,40         | SIKAC 20 M                     | SILKAC 20 M              |
| 22                   | 55                    | M 22×1,5  | 28 | 21                    | 84             | 15                 | 38   | 45             | 0,50         | SIKAC 22 M                     | SILKAC 22 M              |
| 25                   | 61                    | M 24×2    | 31 | 23                    | 94             | 15                 | 47,5 | 53             | 0,65         | SIKAC 25 M                     | SILKAC 25 M              |
| 30                   | 71                    | M 30×2    | 37 | 27                    | 110            | 17                 | 64   | 69,5           | 1,15         | SIKAC 30 M                     | SILKAC 30 M              |
|                      | 71                    | M 27×2    | 37 | 27                    | 110            | 17                 | 64   | 69,5           | 1,15         | SIKAC 30 M/VZ019               | –                        |

<sup>1)</sup>No relubrication facilities.

**Dimensions**

| d         | d <sub>k</sub> | d <sub>3</sub><br>= | d <sub>4</sub><br>max | l <sub>3</sub><br>min | l <sub>4</sub><br>max | l <sub>5</sub><br>= | l <sub>7</sub><br>min | r <sub>1</sub><br>min | w<br>h14 |
|-----------|----------------|---------------------|-----------------------|-----------------------|-----------------------|---------------------|-----------------------|-----------------------|----------|
| mm        |                |                     |                       |                       |                       |                     |                       |                       |          |
| <b>5</b>  | 11,1<br>11,1   | 9<br>9              | 12<br>12              | 8<br>10               | 38<br>38              | 4<br>4              | 9<br>9                | 0,3<br>0,3            | 9<br>9   |
| <b>6</b>  | 12,7           | 10                  | 14                    | 9                     | 42                    | 5                   | 10                    | 0,3                   | 11       |
| <b>8</b>  | 15,8           | 12,5                | 17                    | 12                    | 50                    | 5                   | 12                    | 0,3                   | 14       |
| <b>10</b> | 19<br>19       | 15<br>15            | 20<br>20              | 15<br>20              | 59<br>59              | 6,5<br>6,5          | 14<br>14              | 0,3<br>0,3            | 17<br>17 |
| <b>12</b> | 22,2<br>22,2   | 17,5<br>17,5        | 23<br>23              | 18<br>22              | 68<br>68              | 6,5<br>6,5          | 16<br>16              | 0,3<br>0,3            | 19<br>19 |
| <b>14</b> | 25,4           | 20                  | 27                    | 21                    | 77                    | 8                   | 18                    | 0,3                   | 22       |
| <b>16</b> | 28,5<br>28,5   | 22<br>22            | 29<br>29              | 24<br>28              | 87<br>87              | 8<br>8              | 21<br>21              | 0,3<br>0,3            | 22<br>22 |
| <b>18</b> | 31,7           | 25                  | 32                    | 27                    | 96                    | 10                  | 23                    | 0,3                   | 27       |
| <b>20</b> | 34,9           | 27,5                | 37                    | 30                    | 105                   | 10                  | 25                    | 0,3                   | 30       |
| <b>22</b> | 38,1           | 30                  | 40                    | 33                    | 114                   | 12                  | 27                    | 0,3                   | 32       |
| <b>25</b> | 42,8           | 33,5                | 44                    | 36                    | 127                   | 12                  | 30                    | 0,3                   | 36       |
| <b>30</b> | 50,8<br>50,8   | 40<br>40            | 52<br>52              | 45<br>51              | 148<br>148            | 15<br>15            | 35<br>35              | 0,3<br>0,3            | 41<br>41 |

**Rod ends with a male thread, steel/bronze**  
**d 5 – 30 mm**

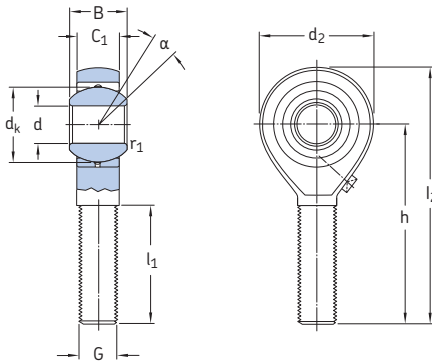

SA(L)KAC... M  
d ≥ 6 mm

| Principal dimensions |                    |          |    |                    |     | Angle of tilt | Basic load ratings |                | Mass  | Designations                   |                          |
|----------------------|--------------------|----------|----|--------------------|-----|---------------|--------------------|----------------|-------|--------------------------------|--------------------------|
| d                    | d <sub>2</sub> max | G 6g     | B  | C <sub>1</sub> max | h   | α             | C                  | C <sub>0</sub> |       | Rod end with right-hand thread | left-hand thread         |
| mm                   |                    |          |    |                    |     | degrees       | kN                 |                | kg    | –                              |                          |
| 5                    | 19                 | M 5      | 8  | 6                  | 33  | 13            | 3,25               | 4,8            | 0,013 | SAKAC 5 M <sup>1)</sup>        | SALKAC 5 M <sup>1)</sup> |
| 6                    | 21                 | M 6      | 9  | 6,75               | 36  | 13            | 4,3                | 4,8            | 0,020 | SAKAC 6 M                      | SALKAC 6 M               |
| 8                    | 25                 | M 8      | 12 | 9                  | 42  | 14            | 7,2                | 8              | 0,032 | SAKAC 8 M                      | SALKAC 8 M               |
| 10                   | 29                 | M 10     | 14 | 10,5               | 48  | 13            | 10                 | 10,8           | 0,054 | SAKAC 10 M                     | SALKAC 10 M              |
| 12                   | 33                 | M 12     | 16 | 12                 | 54  | 13            | 12,2               | 12,2           | 0,085 | SAKAC 12 M                     | SALKAC 12 M              |
| 14                   | 37                 | M 14     | 19 | 13,5               | 60  | 16            | 17                 | 17,3           | 0,13  | SAKAC 14 M                     | SALKAC 14 M              |
| 16                   | 43                 | M 16     | 21 | 15                 | 66  | 16            | 21,6               | 23,2           | 0,19  | SAKAC 16 M                     | SALKAC 16 M              |
| 18                   | 47                 | M 18×1,5 | 23 | 16,5               | 72  | 16            | 26                 | 29             | 0,26  | SAKAC 18 M                     | SALKAC 18 M              |
| 20                   | 51                 | M 20×1,5 | 25 | 18                 | 78  | 16            | 29                 | 29             | 0,34  | SAKAC 20 M                     | SALKAC 20 M              |
| 22                   | 55                 | M 22×1,5 | 28 | 20                 | 84  | 16            | 38                 | 39             | 0,44  | SAKAC 22 M                     | SALKAC 22 M              |
| 25                   | 61                 | M 24×2   | 31 | 22                 | 94  | 15            | 46,5               | 46,5           | 0,60  | SAKAC 25 M                     | SALKAC 25 M              |
| 30                   | 71                 | M 30×2   | 37 | 25                 | 110 | 17            | 61                 | 61             | 1,05  | SAKAC 30 M                     | SALKAC 30 M              |

<sup>1)</sup>No relubrication facilities.

---

**Dimensions**

| d | d <sub>k</sub> | l <sub>1</sub><br>min | l <sub>2</sub><br>max | r <sub>1</sub><br>min |
|---|----------------|-----------------------|-----------------------|-----------------------|
|---|----------------|-----------------------|-----------------------|-----------------------|

---

mm

---

|    |      |    |     |     |
|----|------|----|-----|-----|
| 5  | 11,1 | 19 | 44  | 0,3 |
| 6  | 12,7 | 21 | 48  | 0,3 |
| 8  | 15,8 | 25 | 56  | 0,3 |
| 10 | 19   | 28 | 64  | 0,3 |
| 12 | 22,2 | 32 | 72  | 0,3 |
| 14 | 25,4 | 36 | 80  | 0,3 |
| 16 | 28,5 | 37 | 89  | 0,3 |
| 18 | 31,7 | 41 | 97  | 0,3 |
| 20 | 34,9 | 45 | 106 | 0,3 |
| 22 | 38,1 | 48 | 114 | 0,3 |
| 25 | 42,8 | 55 | 127 | 0,3 |
| 30 | 50,8 | 66 | 148 | 0,3 |



# Maintenance-free rod ends

|  |            |
|--|------------|
| Dimensions .....   | 190        |
| Tolerances .....   | 191        |
| Radial internal clearance, preload .....   | 191        |
| Materials .....  | 192        |
| Permissible operating temperature range .....  | 192        |
| Fatigue strength .....   | 192        |
| <b>Product tables .....</b>  | <b>194</b> |
| 7.1 Maintenance-free rod ends with a female thread, steel/PTFE sintered bronze ..... | 194        |
| 7.2 Maintenance-free rod ends with a male thread, steel/PTFE sintered bronze.....    | 196        |
| 7.3 Maintenance-free rod ends with a female thread, steel/PTFE fabric .....          | 198        |
| 7.4 Maintenance-free rod ends with a male thread, steel/PTFE fabric .....            | 200        |
| 7.5 Maintenance-free rod ends with a female thread, steel/PTFE FRP.....              | 202        |
| 7.6 Maintenance-free rod ends with a male thread, steel/PTFE FRP.....                | 204        |

## Maintenance-free rod ends

SKF manufactures maintenance-free rod ends with three different sliding contact surface combinations in different series:

- Steel/PTFE sintered bronze (→ **fig. 1**):
  - SI(L) .. C series
  - SA(L) .. C series
- Steel/PTFE fabric (→ **fig. 2**):
  - SI(L) .. TXE-2LS series
  - SI(L)A .. TXE-2LS series
  - SA(L) .. TXE-2LS series
  - SA(L)A .. TXE-2LS series
- Steel/PTFE FRP (→ **fig. 3**):
  - SI(L)KB .. F series
  - SA(L)KB .. F series

Rod ends with either a steel/PTFE sintered bronze or steel/PTFE fabric sliding contact surface combination contain a bearing from the standard assortment. The outer ring is staked in place in the housing.

Rod ends with a steel/PTFE FRP sliding contact surface combination consist of a rod end housing and a spherical plain bearing inner ring. Between the housing and the inner ring, a sliding layer of fibre reinforced polymer, containing PTFE, is moulded to the housing.

SKF supplies maintenance-free rod ends with a threaded shank with a right-hand thread as standard. With the exception of rod ends with the designation suffix VZ019, all rod ends are also available with a left-hand thread. They are identified by the designation prefix L.

## Dimensions

The dimensions of SKF maintenance-free rod ends are in accordance with ISO 12240-4:1998.

Male and female threads of SKF rod ends are in accordance with ISO 965-1:1998, except for rod ends with female thread having the designation suffix /VZ019, which is in accordance with ISO 8139:2009.

Fig. 1

Maintenance-free rod end, steel/PTFE sintered bronze

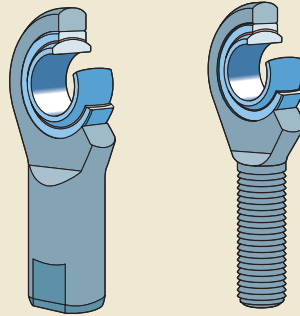

Fig. 2

Maintenance-free rod end, steel/PTFE fabric

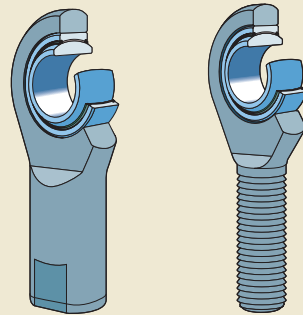
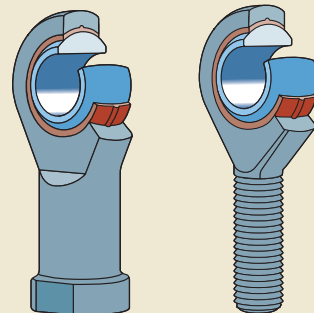

Fig. 3

Maintenance-free rod end, steel/PTFE FRP





## Tolerances

SKF rod end inner ring dimensional tolerances are in accordance with ISO 12240-1:1998. The tolerances are listed in **table 1**.

The symbols used in **table 1** are explained in the following:

- d nominal bore diameter
- $\Delta_{dmp}$  deviation of the mean bore diameter from the nominal
- $\Delta_{Bs}$  deviation of the single inner ring width from the nominal

## Radial internal clearance, preload

Depending on their design, SKF maintenance-free rod ends may have a radial internal clearance or a light preload. **Table 2** lists maximum values for the radial internal clearance as well as for the frictional moment in the circumferential direction caused by preload.

Table 2

### Radial internal clearance and frictional moment for maintenance-free rod ends

| Bore diameter<br>d |       | Radial<br>internal<br>clearance | Frictional<br>moment |
|--------------------|-------|---------------------------------|----------------------|
| over               | incl. | max                             | max                  |
| mm                 |       | $\mu\text{m}$                   | Nm                   |

### Sliding surface steel/PTFE sintered bronze (designation suffix C)

|           |           |    |      |
|-----------|-----------|----|------|
| –         | <b>12</b> | 28 | 0,15 |
| <b>12</b> | <b>20</b> | 35 | 0,25 |
| <b>20</b> | <b>30</b> | 44 | 0,40 |

### Sliding surface steel/PTFE fabric (designation suffix TXE-2LS)

|           |           |    |   |
|-----------|-----------|----|---|
| <b>35</b> | <b>80</b> | 50 | – |
|-----------|-----------|----|---|

### Sliding surface steel/PTFE FRP (designation suffix F)

|           |  |     |      |
|-----------|--|-----|------|
| <b>5</b>  |  | 50  | 0,20 |
| <b>6</b>  |  | 50  | 0,25 |
| <b>8</b>  |  | 50  | 0,30 |
| <b>10</b> |  | 75  | 0,40 |
| <b>12</b> |  | 75  | 0,50 |
| <b>14</b> |  | 75  | 0,60 |
| <b>16</b> |  | 75  | 0,70 |
| <b>18</b> |  | 85  | 0,80 |
| <b>20</b> |  | 100 | 1    |
| <b>22</b> |  | 100 | 1,2  |

Table 1

### Inner ring dimensional tolerances for maintenance-free rod ends

| Bore diameter<br>d |           | SA(A) and SI(A) series |     |               |      | SAKB and SIKB series |     |               |      |
|--------------------|-----------|------------------------|-----|---------------|------|----------------------|-----|---------------|------|
| over               | incl.     | $\Delta_{dmp}$         |     | $\Delta_{Bs}$ |      | $\Delta_{dmp}$       |     | $\Delta_{Bs}$ |      |
|                    |           | high                   | low | high          | low  | high                 | low | high          | low  |
| mm                 |           | $\mu\text{m}$          |     | $\mu\text{m}$ |      | $\mu\text{m}$        |     | $\mu\text{m}$ |      |
| –                  | <b>6</b>  | 0                      | –8  | 0             | –120 | 12                   | 0   | 0             | –120 |
| <b>6</b>           | <b>10</b> | 0                      | –8  | 0             | –120 | 15                   | 0   | 0             | –120 |
| <b>10</b>          | <b>18</b> | 0                      | –8  | 0             | –120 | 18                   | 0   | 0             | –120 |
| <b>18</b>          | <b>30</b> | 0                      | –10 | 0             | –120 | 21                   | 0   | 0             | –120 |
| <b>30</b>          | <b>50</b> | 0                      | –12 | 0             | –120 | –                    | –   | –             | –    |
| <b>50</b>          | <b>80</b> | 0                      | –15 | 0             | –150 | –                    | –   | –             | –    |

## Maintenance-free rod ends

### Materials

SKF rod end housings for maintenance-free bearings are made of materials as listed in **table 3**.

Details of the materials used for the maintenance-free radial spherical plain bearings incorporated in the rod ends are listed in **table 3** on **pages 128 to 129**.

The inner ring of rod ends with a steel/PTFE FRP sliding contact surface combination is made of bearing steel. The ring is through-hardened and ground. The sliding contact surface of the inner ring is hard chromium plated. The sliding layer consists of a fibre reinforced polymer, containing PTFE.

### Permissible operating temperature range

The permissible operating temperature range for SKF maintenance-free rod ends depends on the rod end housing, the incorporated bearing and the bearing seals. The values for the permissible operating temperature range are listed in **table 4**.

The load carrying capacity of the rod end is reduced at temperatures above 100 °C. For temperatures below 0 °C, check to be sure that the fracture toughness of the rod end housing is adequate for the intended application.

### Fatigue strength

In all applications where a rod end is subjected to alternating loads, loads that vary in magnitude or where failure of a rod end is dangerous, make sure that the selected rod end has sufficient fatigue strength.

Table 3

Housing materials for maintenance-free rod ends

| Series         | Size     | Material   | Material No. |
|----------------|----------|--|--------------|
| SA(A)<br>SI(A) | 6 to 80  | Heat treatable steel C45V, zinc coated and chromitized | 1.0503       |
| SAKB<br>SIKB   | 5 to 12  | Free-machining steel, zinc coated and chromitized      | 1.0718       |
|                | 14 to 22 | Heat treatable steel C35N, zinc coated and chromitized | 1.0501       |

Table 4

Permissible operating temperature range for maintenance-free rod ends

| Rod end sliding contact surface combination | Permissible operating temperature range <sup>1)</sup> |       | Reduced load carrying capacity |
|---|---|-------|--------------------------------|
|   | from  | incl. |                                |
| –   | °C  |       | °C                             |
| Steel/PTFE sintered bronze                  | –50   | +150  | +80                            |
| Steel/PTFE fabric                           | –40   | +110  | +65                            |
| Steel/PTFE FRP                              | –40   | +75   | +50                            |

<sup>1)</sup> For temperatures below 0 °C, make sure that the fracture toughness of the rod end housing is adequate for the intended application.



Maintenance-free rod ends with a female thread, steel/PTFE sintered bronze  
d 6 – 30 mm

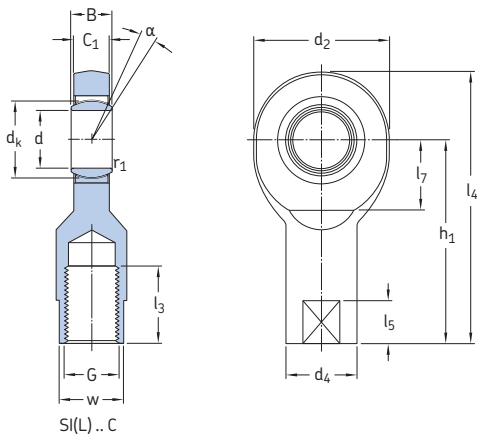

| Principal dimensions |                       |          |    |                       |                | Angle of tilt | Basic load ratings |                | Mass  | Designations                         |                     |
|----------------------|-----------------------|----------|----|-----------------------|----------------|---------------|--------------------|----------------|-------|--------------------------------------|---------------------|
| d                    | d <sub>2</sub><br>max | G<br>6H  | B  | C <sub>1</sub><br>max | h <sub>1</sub> | α             | C                  | C <sub>0</sub> |       | Rod end with<br>right-hand<br>thread | left-hand<br>thread |
| mm                   |                       |          |    |                       |                | degrees       | kN                 |                | kg    | –                                    |                     |
| 6                    | 22                    | M 6      | 6  | 4,5                   | 30             | 13            | 3,6                | 8,15           | 0,023 | SI 6 C                               | SIL 6 C             |
| 8                    | 25                    | M 8      | 8  | 6,5                   | 36             | 15            | 5,8                | 12,9           | 0,036 | SI 8 C                               | SIL 8 C             |
| 10                   | 30                    | M 10     | 9  | 7,5                   | 43             | 12            | 8,65               | 19             | 0,065 | SI 10 C                              | SIL 10 C            |
| 12                   | 35                    | M 12     | 10 | 8,5                   | 50             | 10            | 11,4               | 25,5           | 0,11  | SI 12 C                              | SIL 12 C            |
| 15                   | 41                    | M 14     | 12 | 10,5                  | 61             | 8             | 18                 | 37,5           | 0,18  | SI 15 C                              | SIL 15 C            |
| 17                   | 47                    | M 16     | 14 | 11,5                  | 67             | 10            | 22,4               | 46,5           | 0,25  | SI 17 C                              | SIL 17 C            |
| 20                   | 54                    | M 20×1,5 | 16 | 13,5                  | 77             | 9             | 31,5               | 57             | 0,35  | SI 20 C                              | SIL 20 C            |
| 25                   | 65                    | M 24×2   | 20 | 18                    | 94             | 7             | 51                 | 90             | 0,65  | SI 25 C                              | SIL 25 C            |
| 30                   | 75                    | M 30×2   | 22 | 20                    | 110            | 6             | 65,5               | 118            | 1,05  | SI 30 C                              | SIL 30 C            |

---

**Dimensions**

| d  | d <sub>k</sub> | d <sub>4</sub><br>≈ | l <sub>3</sub><br>min | l <sub>4</sub><br>max | l <sub>5</sub><br>≈ | l <sub>7</sub><br>min | r <sub>1</sub><br>min | w<br>h14 |
|----|----------------|---------------------|-----------------------|-----------------------|---------------------|-----------------------|-----------------------|----------|
| 6  | 10             | 11                  | 11                    | 43                    | 8                   | 10                    | 0,3                   | 9        |
| 8  | 13             | 13                  | 15                    | 50                    | 9                   | 11                    | 0,3                   | 11       |
| 10 | 16             | 16                  | 15                    | 60                    | 11                  | 13                    | 0,3                   | 14       |
| 12 | 18             | 19                  | 18                    | 69                    | 12                  | 17                    | 0,3                   | 17       |
| 15 | 22             | 22                  | 21                    | 83                    | 14                  | 19                    | 0,3                   | 19       |
| 17 | 25             | 25                  | 24                    | 92                    | 15                  | 22                    | 0,3                   | 22       |
| 20 | 29             | 28                  | 30                    | 106                   | 16                  | 24                    | 0,3                   | 24       |
| 25 | 35,5           | 35                  | 36                    | 128                   | 18                  | 30                    | 0,6                   | 30       |
| 30 | 40,7           | 42                  | 45                    | 149                   | 19                  | 34                    | 0,6                   | 36       |

Maintenance-free rod ends with a male thread, steel/PTFE sintered bronze  
d 6 – 30 mm

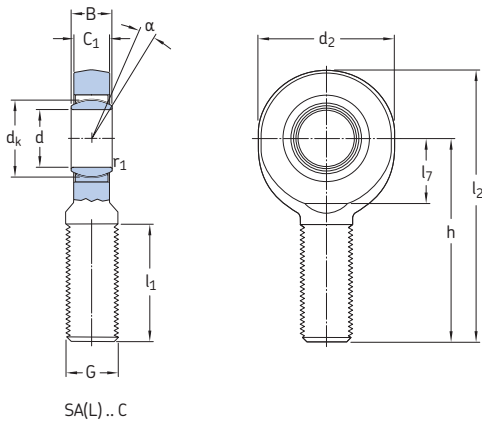

| Principal dimensions |                    |          |    |                    |     | Angle of tilt | Basic load ratings |                | Mass  | Designations                   |                  |
|----------------------|--------------------|----------|----|--------------------|-----|---------------|--------------------|----------------|-------|--------------------------------|------------------|
| d                    | d <sub>2</sub> max | G 6g     | B  | C <sub>1</sub> max | h   | α             | C                  | C <sub>0</sub> |       | Rod end with right-hand thread | left-hand thread |
| mm                   |                    |          |    |                    |     | degrees       | kN                 |                | kg    | –                              |                  |
| 6                    | 22                 | M 6      | 6  | 4,5                | 36  | 13            | 3,6                | 8,15           | 0,017 | SA 6 C                         | SAL 6 C          |
| 8                    | 25                 | M 8      | 8  | 6,5                | 42  | 15            | 5,85               | 12,9           | 0,030 | SA 8 C                         | SAL 8 C          |
| 10                   | 30                 | M 10     | 9  | 7,5                | 48  | 12            | 8,65               | 18,3           | 0,053 | SA 10 C                        | SAL 10 C         |
| 12                   | 35                 | M 12     | 10 | 8,5                | 54  | 10            | 11,4               | 24,5           | 0,078 | SA 12 C                        | SAL 12 C         |
| 15                   | 41                 | M 14     | 12 | 10,5               | 63  | 8             | 18                 | 34,5           | 0,13  | SA 15 C                        | SAL 15 C         |
| 17                   | 47                 | M 16     | 14 | 11,5               | 69  | 10            | 22,4               | 42,5           | 0,19  | SA 17 C                        | SAL 17 C         |
| 20                   | 54                 | M 20×1,5 | 16 | 13,5               | 78  | 9             | 31,5               | 51             | 0,32  | SA 20 C                        | SAL 20 C         |
| 25                   | 65                 | M 24×2   | 20 | 18                 | 94  | 7             | 51                 | 78             | 0,57  | SA 25 C                        | SAL 25 C         |
| 30                   | 75                 | M 30×2   | 22 | 20                 | 110 | 6             | 65,5               | 104            | 0,90  | SA 30 C                        | SAL 30 C         |

---

**Dimensions**

| d  | d <sub>k</sub> | l <sub>1</sub><br>min | l <sub>2</sub><br>max | l <sub>7</sub><br>min | r <sub>1</sub><br>min |
|----|----------------|-----------------------|-----------------------|-----------------------|-----------------------|
| mm |                |                       |                       |                       |                       |
| 6  | 10             | 16                    | 49                    | 10                    | 0,3                   |
| 8  | 13             | 21                    | 56                    | 11                    | 0,3                   |
| 10 | 16             | 26                    | 65                    | 13                    | 0,3                   |
| 12 | 18             | 28                    | 73                    | 17                    | 0,3                   |
| 15 | 22             | 34                    | 85                    | 19                    | 0,3                   |
| 17 | 25             | 36                    | 94                    | 22                    | 0,3                   |
| 20 | 29             | 43                    | 107                   | 24                    | 0,3                   |
| 25 | 35,5           | 53                    | 128                   | 30                    | 0,6                   |
| 30 | 40,7           | 65                    | 149                   | 34                    | 0,6                   |

# Maintenance-free rod ends with a female thread, steel/PTFE fabric

d 35 – 80 mm

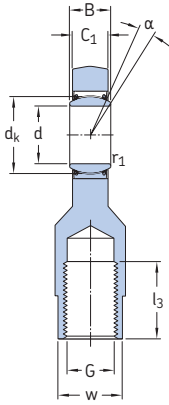

SI(L)..TXE-2LS

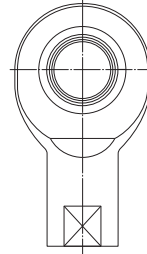
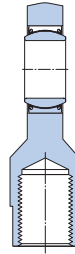
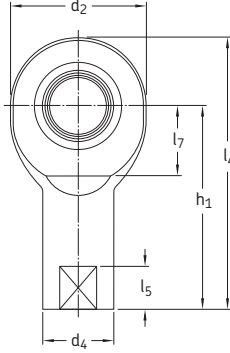

SI(LA)..TXE-2LS

| Principal dimensions |                       |         |    | Angle of tilt<br>$\alpha$ | Basic load ratings <sup>1)</sup> |                | Mass | Designations                         |                     |                |                 |
|----------------------|-----------------------|---------|----|---------------------------|----------------------------------|----------------|------|--------------------------------------|---------------------|----------------|-----------------|
| d                    | d <sub>2</sub><br>max | G<br>6H | B  |                           | C                                | C <sub>0</sub> |      | Rod end with<br>right-hand<br>thread | left-hand<br>thread |                |                 |
| mm                   |                       |         |    | degrees                   | kN                               |                | kg   | -                                    |                     |                |                 |
| 35                   | 84                    | M 36×3  | 25 | 22                        | 130                              | 6              | 224  | 134                                  | 1,40                | SI 35 TXE-2LS  | SIL 35 TXE-2LS  |
|                      |                       |         | 28 | 24                        | 142                              | 7              | 280  | 166                                  | 2,20                | SIA 40 TXE-2LS | SILA 40 TXE-2LS |
| 40                   | 94                    | M 42×3  | 28 | 24                        | 145                              | 7              | 280  | 166                                  | 2,30                | SI 40 TXE-2LS  | SIL 40 TXE-2LS  |
|                      |                       |         | 32 | 28                        | 165                              | 7              | 360  | 224                                  | 2,90                | SIA 45 TXE-2LS | SILA 45 TXE-2LS |
| 45                   | 104                   | M 45×3  | 32 | 28                        | 165                              | 7              | 360  | 224                                  | 3,20                | SI 45 TXE-2LS  | SIL 45 TXE-2LS  |
|                      |                       |         | 35 | 31                        | 195                              | 6              | 440  | 270                                  | 4,10                | SIA 50 TXE-2LS | SILA 50 TXE-2LS |
| 50                   | 114                   | M 52×3  | 35 | 31                        | 195                              | 6              | 440  | 270                                  | 4,50                | SI 50 TXE-2LS  | SIL 50 TXE-2LS  |
|                      |                       |         | 44 | 39                        | 225                              | 6              | 695  | 400                                  | 6,30                | SIA 60 TXE-2LS | SILA 60 TXE-2LS |
| 60                   | 137                   | M 60×4  | 44 | 39                        | 225                              | 6              | 695  | 400                                  | 7,10                | SI 60 TXE-2LS  | SIL 60 TXE-2LS  |
|                      |                       |         | 49 | 43                        | 265                              | 6              | 880  | 530                                  | 10,5                | SI 70 TXE-2LS  | SIL 70 TXE-2LS  |
| 70                   | 162                   | M 72×4  | 49 | 43                        | 265                              | 6              | 880  | 530                                  | 10,5                | SI 70 TXE-2LS  | SIL 70 TXE-2LS  |
| 80                   | 182                   | M 80×4  | 55 | 48                        | 295                              | 5              | 1140 | 655                                  | 19,0                | SI 80 TXE-2LS  | SIL 80 TXE-2LS  |

<sup>1)</sup> Dynamic load rating of the bearing to be used for basic rating life calculation only. Check suitability of the rod end against its static load rating in all cases. The dynamic load applied on the rod end must not exceed its static load rating.



---

**Dimensions**

| d         | d <sub>k</sub> | d <sub>4</sub><br>≈ | l <sub>3</sub><br>min | l <sub>4</sub><br>max | l <sub>5</sub><br>≈ | l <sub>7</sub><br>min | r <sub>1</sub><br>min | w<br>h14 |
|-----------|----------------|---------------------|-----------------------|-----------------------|---------------------|-----------------------|-----------------------|----------|
| mm        |                |                     |                       |                       |                     |                       |                       |          |
| <b>35</b> | 47             | 49                  | 60                    | 174                   | 25                  | 40                    | 0,6                   | 41       |
| <b>40</b> | 53<br>53       | 58<br>58            | 65<br>65              | 191<br>194            | 25<br>25            | 46<br>46              | 0,6<br>0,6            | 50<br>50 |
| <b>45</b> | 60<br>60       | 65<br>65            | 65<br>65              | 199<br>219            | 30<br>30            | 50<br>50              | 0,6<br>0,6            | 55<br>55 |
| <b>50</b> | 66<br>66       | 70<br>70            | 68<br>68              | 219<br>254            | 30<br>30            | 58<br>58              | 0,6<br>0,6            | 60<br>60 |
| <b>60</b> | 80<br>80       | 82<br>82            | 70<br>70              | 246<br>296            | 35<br>35            | 73<br>73              | 1<br>1                | 70<br>70 |
| <b>70</b> | 92             | 92                  | 80                    | 349                   | 40                  | 85                    | 1                     | 80       |
| <b>80</b> | 105            | 105                 | 85                    | 389                   | 40                  | 98                    | 1                     | 90       |

**Maintenance-free rod ends with a male thread, steel/PTFE fabric**  
**d 35 – 80 mm**

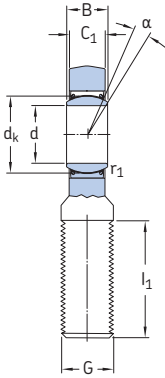

SA(L) .. TXE-2LS

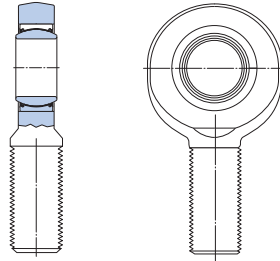
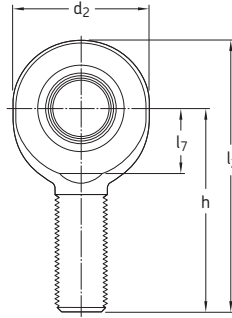

SA(L)A .. TXE-2LS

| Principal dimensions |                       |         |    |                       |     | Angle of tilt | Basic load ratings <sup>1)</sup> |                | Mass | Designations                         |                     |
|----------------------|-----------------------|---------|----|-----------------------|-----|---------------|----------------------------------|----------------|------|--------------------------------------|---------------------|
| d                    | d <sub>2</sub><br>max | G<br>6g | B  | C <sub>1</sub><br>max | h   | α             | C                                | C <sub>0</sub> |      | Rod end with<br>right-hand<br>thread | left-hand<br>thread |
| mm                   |                       |         |    |                       |     | degrees       | kN                               |                | kg   | –                                    |                     |
| 35                   | 84                    | M 36×3  | 25 | 22                    | 130 | 6             | 224                              | 110            | 1,30 | SA 35 TXE-2LS                        | SAL 35 TXE-2LS      |
|                      | 94                    | M 39×3  | 28 | 24                    | 150 | 6             | 280                              | 140            | 1,85 | SAA 40 TXE-2LS                       | SALA 40 TXE-2LS     |
| 40                   | 94                    | M 42×3  | 28 | 24                    | 145 | 6             | 280                              | 140            | 1,90 | SA 40 TXE-2LS                        | SAL 40 TXE-2LS      |
|                      | 104                   | M 42×3  | 32 | 28                    | 163 | 7             | 360                              | 200            | 2,45 | SAA 45 TXE-2LS                       | SALA 45 TXE-2LS     |
| 45                   | 104                   | M 45×3  | 32 | 28                    | 165 | 7             | 360                              | 200            | 2,55 | SA 45 TXE-2LS                        | SAL 45 TXE-2LS      |
|                      | 114                   | M 45×3  | 35 | 31                    | 185 | 6             | 440                              | 245            | 3,30 | SAA 50 TXE-2LS                       | SALA 50 TXE-2LS     |
| 50                   | 114                   | M 52×3  | 35 | 31                    | 195 | 6             | 440                              | 245            | 3,90 | SA 50 TXE-2LS                        | SAL 50 TXE-2LS      |
|                      | 137                   | M 52×3  | 44 | 39                    | 210 | 6             | 695                              | 360            | 5,70 | SAA 60 TXE-2LS                       | SALA 60 TXE-2LS     |
| 60                   | 137                   | M 60×4  | 44 | 39                    | 225 | 6             | 695                              | 360            | 6,25 | SA 60 TXE-2LS                        | SAL 60 TXE-2LS      |
|                      | 162                   | M 72×4  | 49 | 43                    | 265 | 6             | 880                              | 490            | 10,0 | SA 70 TXE-2LS                        | SAL 70 TXE-2LS      |
| 70                   | 162                   | M 72×4  | 49 | 43                    | 265 | 6             | 880                              | 490            | 10,0 | SA 70 TXE-2LS                        | SAL 70 TXE-2LS      |
| 80                   | 182                   | M 80×4  | 55 | 48                    | 295 | 5             | 1140                             | 585            | 14,5 | SA 80 TXE-2LS                        | SAL 80 TXE-2LS      |

<sup>1)</sup> Dynamic load rating of the bearing to be used for basic rating life calculation only. Check suitability of the rod end against its static load rating in all cases. The dynamic load applied on the rod end must not exceed its static load rating.

---

**Dimensions**

| d         | d <sub>k</sub> | l <sub>1</sub><br>min | l <sub>2</sub><br>max | l <sub>7</sub><br>min | r <sub>1</sub><br>min |
|-----------|----------------|-----------------------|-----------------------|-----------------------|-----------------------|
| mm        |                |                       |                       |                       |                       |
| <b>35</b> | 47             | 82                    | 174                   | 40                    | 0,6                   |
| <b>40</b> | 53<br>53       | 86<br>90              | 199<br>194            | 46<br>46              | 0,6<br>0,6            |
| <b>45</b> | 60<br>60       | 92<br>95              | 217<br>219            | 50<br>50              | 0,6<br>0,6            |
| <b>50</b> | 66<br>66       | 104<br>110            | 244<br>254            | 58<br>58              | 0,6<br>0,6            |
| <b>60</b> | 80<br>80       | 115<br>120            | 281<br>296            | 73<br>73              | 1<br>1                |
| <b>70</b> | 92             | 132                   | 349                   | 85                    | 1                     |
| <b>80</b> | 105            | 147                   | 389                   | 98                    | 1                     |

Maintenance-free rod ends with a female thread, steel/PTFE FRP  
d 5 – 22 mm

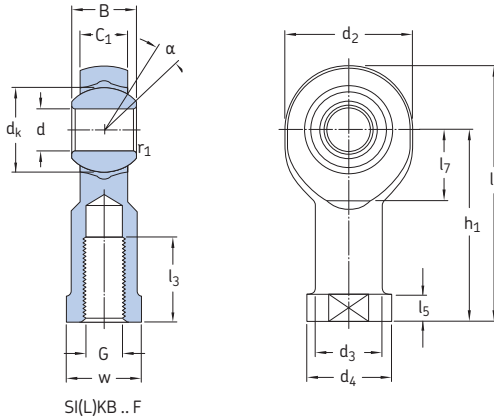

| Principal dimensions |                       |           |    |                       |                | Angle of tilt | Basic load ratings |                | Mass  | Designations                         |                     |
|----------------------|-----------------------|-----------|----|-----------------------|----------------|---------------|--------------------|----------------|-------|--------------------------------------|---------------------|
| d                    | d <sub>2</sub><br>max | G<br>6H   | B  | C <sub>1</sub><br>max | h <sub>1</sub> | α             | C                  | C <sub>0</sub> |       | Rod end with<br>right-hand<br>thread | left-hand<br>thread |
| mm                   |                       |           |    |                       |                | degrees       | kN                 |                | kg    | –                                    |                     |
| 5                    | 19                    | M 5       | 8  | 6                     | 27             | 13            | 3,25               | 5,3            | 0,019 | SIKB 5 F                             | SILKB 5 F           |
| 6                    | 21                    | M 6       | 9  | 6,75                  | 30             | 13            | 4,25               | 6,8            | 0,028 | SIKB 6 F                             | SILKB 6 F           |
| 8                    | 25                    | M 8       | 12 | 9                     | 36             | 14            | 7,1                | 11,4           | 0,047 | SIKB 8 F                             | SILKB 8 F           |
| 10                   | 29                    | M 10      | 14 | 10,5                  | 43             | 13            | 9,8                | 14,3           | 0,079 | SIKB 10 F                            | SILKB 10 F          |
|                      | 29                    | M 10×1,25 | 14 | 10,5                  | 43             | 13            | 9,8                | 14,3           | 0,079 | SIKB 10 F/VZ019                      | –                   |
| 12                   | 33                    | M 12      | 16 | 12                    | 50             | 13            | 13,2               | 17             | 0,12  | SIKB 12 F                            | SILKB 12 F          |
|                      | 33                    | M 12×1,25 | 16 | 12                    | 50             | 13            | 13,2               | 17             | 0,12  | SIKB 12 F/VZ019                      | –                   |
| 14                   | 37                    | M 14      | 19 | 13,5                  | 57             | 16            | 17                 | 27,5           | 0,16  | SIKB 14 F                            | SILKB 14 F          |
| 16                   | 43                    | M 16      | 21 | 15                    | 64             | 15            | 21,4               | 34,5           | 0,23  | SIKB 16 F                            | SILKB 16 F          |
|                      | 43                    | M 16×1,5  | 21 | 15                    | 64             | 15            | 21,4               | 34,5           | 0,23  | SIKB 16 F/VZ019                      | –                   |
| 18                   | 47                    | M 18×1,5  | 23 | 16,5                  | 71             | 15            | 26                 | 41,5           | 0,33  | SIKB 18 F                            | SILKB 18 F          |
| 20                   | 51                    | M 20×1,5  | 25 | 18                    | 77             | 14            | 31                 | 50             | 0,38  | SIKB 20 F                            | SILKB 20 F          |
| 22                   | 55                    | M 22×1,5  | 28 | 20                    | 84             | 15            | 38                 | 61             | 0,52  | SIKB 22 F                            | SILKB 22 F          |

### Dimensions

| d  | d <sub>k</sub> | d <sub>3</sub><br>≈ | d <sub>4</sub><br>max | l <sub>3</sub><br>min | l <sub>4</sub><br>max | l <sub>5</sub><br>≈ | l <sub>7</sub><br>min | r <sub>1</sub><br>min | w<br>h14 |
|----|----------------|---------------------|-----------------------|-----------------------|-----------------------|---------------------|-----------------------|-----------------------|----------|
| mm |                |                     |                       |                       |                       |                     |                       |                       |          |
| 5  | 11,1           | 9                   | 12                    | 8                     | 37                    | 4                   | 9                     | 0,3                   | 9        |
| 6  | 12,7           | 10                  | 14                    | 9                     | 41                    | 5                   | 10                    | 0,3                   | 11       |
| 8  | 15,8           | 12,5                | 17                    | 12                    | 49                    | 5                   | 12                    | 0,3                   | 14       |
| 10 | 19             | 15                  | 20                    | 15                    | 58                    | 6,5                 | 14                    | 0,3                   | 17       |
|    | 19             | 15                  | 20                    | 20                    | 58                    | 6,5                 | 14                    | 0,3                   | 17       |
| 12 | 22,2           | 17,5                | 23                    | 18                    | 67                    | 6,5                 | 16                    | 0,3                   | 19       |
|    | 22,2           | 17,5                | 23                    | 22                    | 67                    | 6,5                 | 16                    | 0,3                   | 19       |
| 14 | 25,4           | 20                  | 27                    | 21                    | 76                    | 8                   | 18                    | 0,3                   | 22       |
| 16 | 28,5           | 22                  | 29                    | 24                    | 86                    | 8                   | 21                    | 0,3                   | 22       |
|    | 28,5           | 22                  | 29                    | 28                    | 86                    | 8                   | 21                    | 0,3                   | 22       |
| 18 | 31,7           | 25                  | 32                    | 27                    | 95                    | 10                  | 23                    | 0,3                   | 27       |
| 20 | 34,9           | 27,5                | 37                    | 30                    | 103                   | 10                  | 25                    | 0,3                   | 30       |
| 22 | 38,1           | 30                  | 40                    | 33                    | 114                   | 12                  | 27                    | 0,3                   | 32       |

Maintenance-free rod ends with a male thread, steel/PTFE FRP  
d 5 – 22 mm

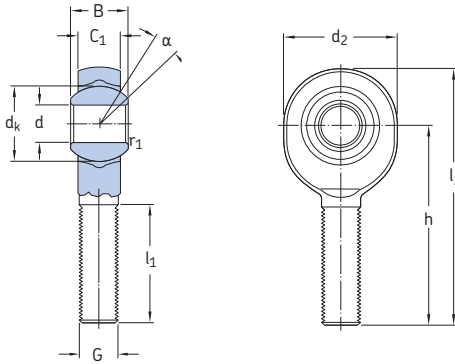

SA(L)KB ..F

| Principal dimensions |                       |         |    |                       |    | Angle of tilt | Basic load ratings |                | Mass  | Designations                   |                  |
|----------------------|-----------------------|---------|----|-----------------------|----|---------------|--------------------|----------------|-------|--------------------------------|------------------|
| d                    | d <sub>2</sub><br>max | G<br>6g | B  | C <sub>1</sub><br>max | h  | α             | C                  | C <sub>0</sub> |       | Rod end with right-hand thread | left-hand thread |
| mm                   |                       |         |    |                       |    | degrees       | kN                 |                | kg    | –                              |                  |
| 5                    | 19                    | M5      | 8  | 6                     | 33 | 13            | 3,25               | 5,3            | 0,015 | SAKB 5 F                       | SALKB 5 F        |
| 6                    | 21                    | M6      | 9  | 6,75                  | 36 | 13            | 4,25               | 6,8            | 0,021 | SAKB 6 F                       | SALKB 6 F        |
| 8                    | 25                    | M8      | 12 | 9                     | 42 | 14            | 7,1                | 10             | 0,035 | SAKB 8 F                       | SALKB 8 F        |
| 10                   | 29                    | M10     | 14 | 10,5                  | 48 | 13            | 9,8                | 12,5           | 0,059 | SAKB 10 F                      | SALKB 10 F       |
| 12                   | 33                    | M12     | 16 | 12                    | 54 | 13            | 13,2               | 15             | 0,10  | SAKB 12 F                      | SALKB 12 F       |
| 14                   | 37                    | M14     | 19 | 13,5                  | 60 | 16            | 17                 | 25,5           | 0,13  | SAKB 14 F                      | SALKB 14 F       |
| 16                   | 43                    | M16     | 21 | 15                    | 66 | 15            | 21,4               | 34,5           | 0,20  | SAKB 16 F                      | SALKB 16 F       |
| 18                   | 47                    | M18×1,5 | 23 | 16,5                  | 72 | 15            | 26                 | 41,5           | 0,26  | SAKB 18 F                      | SALKB 18 F       |
| 20                   | 51                    | M20×1,5 | 25 | 18                    | 78 | 14            | 31                 | 50             | 0,37  | SAKB 20 F                      | SALKB 20 F       |
| 22                   | 55                    | M22×1,5 | 28 | 20                    | 84 | 15            | 38                 | 58,5           | 0,46  | SAKB 22 F                      | SALKB 22 F       |

---

**Dimensions**

| d | d <sub>k</sub> | l <sub>1</sub><br>min | l <sub>2</sub><br>max | r <sub>1</sub><br>min |
|---|----------------|-----------------------|-----------------------|-----------------------|
|---|----------------|-----------------------|-----------------------|-----------------------|

---

mm

---

|    |      |    |     |     |
|----|------|----|-----|-----|
| 5  | 11,1 | 19 | 44  | 0,3 |
| 6  | 12,7 | 21 | 48  | 0,3 |
| 8  | 15,8 | 25 | 56  | 0,3 |
| 10 | 19   | 28 | 64  | 0,3 |
| 12 | 22,2 | 32 | 72  | 0,3 |
| 14 | 25,4 | 36 | 80  | 0,3 |
| 16 | 28,5 | 37 | 89  | 0,3 |
| 18 | 31,7 | 41 | 97  | 0,3 |
| 20 | 34,9 | 45 | 106 | 0,3 |
| 22 | 38,1 | 48 | 114 | 0,3 |





# Other SKF plain bearings and special solutions

|  |     |
|--|-----|
| Spherical plain bearings for road vehicles.....                      | 208 |
| Plain bearings for railway vehicles .....                            | 208 |
| Bushing units for off highway vehicles .....                         | 208 |
| Spherical plain bearings and rod ends for the aircraft industry..... | 209 |
| Bushings, thrust washers and strips .....                            | 209 |
| Rod ends for the food industry .....                                 | 210 |

## Other SKF plain bearings and special solutions

### Spherical plain bearings for road vehicles

SKF spherical plain bearings or bearing units are also available for special applications. Therefore, SKF works closely with the customer to develop customized products, e.g. solutions for centring propeller shafts or gear shifts.



### Plain bearings for railway vehicles

The SKF assortment of plain bearings for railway vehicles includes bogie swivel bearings for trams and heavy-duty goods wagons as well as spherical plain bearings and rod ends for transverse stabilizers, tilting mechanisms etc.



### Bushing units for off-highway vehicles

Many off-highway vehicles have bushings made of steel or bronze that require relubrication. SKF has developed state-of-the-art bushing units with seals. As these units do not require grease, costs are reduced and productivity is increased.

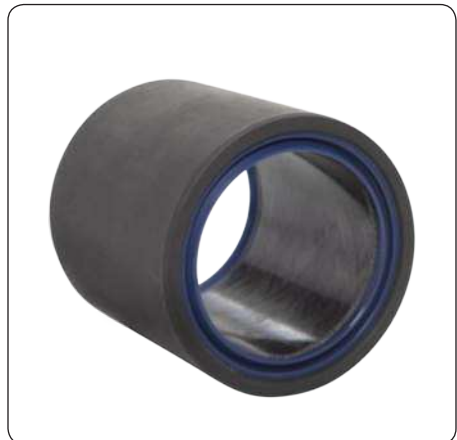

## Spherical plain bearings and rod ends for the aircraft industry

SKF supplies a wide assortment of special spherical plain bearings and rod ends in various designs and materials for aerospace applications worldwide. The main applications are air-frame bearings for the transmission of rotating, tilting and oscillating movements as used in undercarriages, spoilers, height and side rudders, wing flaps etc.



## Bushings, thrust washers and strips

SKF offers a wide assortment of bushings available from stock. Bushings are suitable for rotating, oscillating and linear movements and are available as cylindrical or flanged designs. Thrust washers are intended for applications where axial space is limited, maintenance is not possible and where lubricant starvation can occur.

SKF also supplies strips made of the same materials as thrust washers. They can be bent, pressed or coined to form flat linear guides, e.g. L-shaped or V-shaped profiles, or other types of dry sliding components.

Different materials meet different requirements:

- solid bronze, the traditional robust material
- sintered bronze with oil impregnation, for high sliding velocities
- wrapped bronze with lubrication pockets, for contaminated environments
- PTFE composite with reduced friction, for long service life
- POM composite, for minimal maintenance under arduous conditions
- PTFE polyamide, cost-effective and maintenance-free
- filament wound, for extreme conditions



### Rod ends for the food industry

The food and beverage processing industries have unique requirements. Depending on the application, equipment has to withstand the following influences:

- hot, cold or wet environments
- frequent wash downs
- exposure to harsh cleaning agents
- food and liquid contaminants
- a variety of chemicals

To deal with these challenging operating conditions, SKF offers rod ends with a stainless steel housing or with a composite housing. Both series are equipped with a stainless steel inner ring and an injection moulded PTFE FRP dry sliding layer. The used materials provide the following properties:

- corrosion resistant
- good wear resistance
- low friction
- cost-effective







# Product index

| Designation      | Product   | Product Page | table |
|------------------|---|--------------|-------|
| GAC .. F         | Maintenance-free angular contact spherical plain bearings, steel/PTFE FRP                                     | 4.1          | 156   |
| GE .. C          | Maintenance-free radial spherical plain bearings, steel/PTFE sintered bronze, metric sizes                    | 3.1          | 132   |
| GE .. CJ2        | Maintenance-free radial spherical plain bearings, steel/PTFE sintered bronze, metric sizes                    | 3.1          | 132   |
| GE .. E          | Radial spherical plain bearings requiring maintenance, steel/steel, metric sizes                              | 2.1          | 104   |
| GE .. ES         | Radial spherical plain bearings requiring maintenance, steel/steel, metric sizes                              | 2.1          | 104   |
| GE .. ES-2LS     | Radial spherical plain bearings requiring maintenance, steel/steel, metric sizes                              | 2.1          | 104   |
| GE .. ES-2RS     | Radial spherical plain bearings requiring maintenance, steel/steel, metric sizes                              | 2.1          | 104   |
| GE .. TXA-2LS    | Maintenance-free radial spherical plain bearings, steel/PTFE fabric, metric sizes                             | 3.2          | 134   |
| GE .. TXE-2LS    | Maintenance-free radial spherical plain bearings, steel/PTFE fabric, metric sizes                             | 3.2          | 134   |
| GE .. TXG3A-2LS  | Maintenance-free radial spherical plain bearings, steel/PTFE fabric, metric sizes                             | 3.2          | 134   |
| GE .. TXG3E-2LS  | Maintenance-free radial spherical plain bearings, steel/PTFE fabric, metric sizes                             | 3.2          | 134   |
| GE .. TXG        | Maintenance-free radial spherical plain bearings, steel/PTFE fabric, metric sizes                             | 3.2          | 134   |
| GEC .. FBAS      | Maintenance-free radial spherical plain bearings, steel/PTFE FRP, metric sizes                                | 3.4          | 144   |
| GEC .. TXA-2RS   | Maintenance-free radial spherical plain bearings, steel/PTFE fabric, metric sizes                             | 3.2          | 134   |
| GEG .. ES        | Radial spherical plain bearings requiring maintenance, steel/steel, with an extended inner ring, metric sizes | 2.3          | 116   |
| GEG .. ESA       | Radial spherical plain bearings requiring maintenance, steel/steel, with an extended inner ring, metric sizes | 2.3          | 116   |
| GEH .. C         | Maintenance-free radial spherical plain bearings, steel/PTFE sintered bronze, metric sizes                    | 3.1          | 132   |
| GEH .. ES-2LS    | Radial spherical plain bearings requiring maintenance, steel/steel, metric sizes                              | 2.1          | 104   |
| GEH .. ES-2RS    | Radial spherical plain bearings requiring maintenance, steel/steel, metric sizes                              | 2.1          | 104   |
| GEH .. TXA-2LS   | Maintenance-free radial spherical plain bearings, steel/PTFE fabric, metric sizes                             | 3.2          | 134   |
| GEH .. TXE-2LS   | Maintenance-free radial spherical plain bearings, steel/PTFE fabric, metric sizes                             | 3.2          | 134   |
| GEH .. TXG3A-2LS | Maintenance-free radial spherical plain bearings, steel/PTFE fabric, metric sizes                             | 3.2          | 134   |
| GEH .. TXG3E-2LS | Maintenance-free radial spherical plain bearings, steel/PTFE fabric, metric sizes                             | 3.2          | 134   |
| GEM .. ES-2LS    | Radial spherical plain bearings requiring maintenance, steel/steel, with an extended inner ring, metric sizes | 2.3          | 116   |
| GEM .. ES-2RS    | Radial spherical plain bearings requiring maintenance, steel/steel, with an extended inner ring, metric sizes | 2.3          | 116   |
| GEP .. FS        | Maintenance-free radial spherical plain bearings, steel/PTFE FRP, metric sizes                                | 3.4          | 144   |
| GEZ .. ES        | Radial spherical plain bearings requiring maintenance, steel/steel, inch sizes                                | 2.2          | 110   |
| GEZ .. ES-2LS    | Radial spherical plain bearings requiring maintenance, steel/steel, inch sizes                                | 2.2          | 110   |
| GEZ .. ES-2RS    | Radial spherical plain bearings requiring maintenance, steel/steel, inch sizes                                | 2.2          | 110   |
| GEZ .. TXA-2LS   | Maintenance-free radial spherical plain bearings, steel/PTFE fabric, inch sizes                               | 3.3          | 140   |
| GEZ .. TXE-2LS   | Maintenance-free radial spherical plain bearings, steel/PTFE fabric, inch sizes                               | 3.3          | 140   |
| GEZH .. ES       | Radial spherical plain bearings requiring maintenance, steel/steel, inch sizes                                | 2.2          | 110   |
| GEZH .. ES-2LS   | Radial spherical plain bearings requiring maintenance, steel/steel, inch sizes                                | 2.2          | 110   |
| GEZH .. ES-2RS   | Radial spherical plain bearings requiring maintenance, steel/steel, inch sizes                                | 2.2          | 110   |
| GEZM .. ES       | Radial spherical plain bearings requiring maintenance, steel/steel, with an extended inner ring, inch sizes   | 2.4          | 120   |
| GEZM .. ES-2LS   | Radial spherical plain bearings requiring maintenance, steel/steel, with an extended inner ring, inch sizes   | 2.4          | 120   |
| GEZM .. ES-2RS   | Radial spherical plain bearings requiring maintenance, steel/steel, with an extended inner ring, inch sizes   | 2.4          | 120   |
| GX .. F          | Maintenance-free thrust spherical plain bearings, steel/PTFE FRP  | 5.1          | 164   |
| SA .. C          | Maintenance-free rod ends, male thread, steel/PTFE sintered bronze  | 7.2          | 196   |
| SA .. E          | Rod ends requiring maintenance, male thread, steel/steel  | 6.3          | 178   |
| SA .. ES         | Rod ends requiring maintenance, male thread, steel/steel  | 6.3          | 178   |
| SA .. ES-2RS     | Rod ends requiring maintenance, male thread, steel/steel  | 6.3          | 178   |
| SA .. TXE-2LS    | Maintenance-free rod ends, male thread, steel/PTFE fabric   | 7.4          | 200   |
| SAA .. ES-2RS    | Rod ends requiring maintenance, male thread, steel/steel  | 6.3          | 178   |
| SAA .. TXE-2LS   | Maintenance-free rod ends, male thread, steel/PTFE fabric   | 7.4          | 200   |
| SAKAC .. M       | Rod ends requiring maintenance, male thread, steel/PTFE fabric  | 6.7          | 186   |
| SAKB .. F        | Maintenance-free rod ends, male thread, steel/PTFE FRP  | 7.6          | 204   |
| SAL .. C         | Maintenance-free rod ends, male thread, steel/PTFE sintered bronze  | 7.2          | 196   |
| SAL .. E         | Rod ends requiring maintenance, male thread, steel/steel  | 6.3          | 178   |

## Product index

| Designation      | Product   | Product table | Page |
|------------------|---|---------------|------|
| SAL .. ES        | Rod ends requiring maintenance, male thread, steel/steel                                  | 6.3           | 178  |
| SAL .. ES-2RS    | Rod ends requiring maintenance, male thread, steel/steel                                  | 6.3           | 178  |
| SAL .. TXE-2LS   | Maintenance-free rod ends, male thread, steel/PTFE fabric                                 | 7.4           | 200  |
| SALA .. ES-2RS   | Rod ends requiring maintenance, male thread, steel/steel                                  | 6.3           | 178  |
| SALA .. TXE-2LS  | Maintenance-free rod ends, male thread, steel/PTFE fabric                                 | 7.4           | 200  |
| SALKAC .. M      | Rod ends requiring maintenance, male thread, steel/bronze                                 | 6.7           | 186  |
| SALKB .. F       | Maintenance-free rod ends, male thread, steel/PTFE FRP                                    | 7.6           | 204  |
| SC .. ES         | Rod ends requiring maintenance, cylindrical section welding shank, steel/steel            | 6.4           | 180  |
| SCF .. ES        | Rod ends requiring maintenance, rectangular section welding shank, steel/steel            | 6.5           | 182  |
| SI .. C          | Maintenance-free rod ends, female thread, steel/PTFE sintered bronze                      | 7.1           | 194  |
| SI .. E          | Rod ends requiring maintenance, female thread, steel/steel                                | 6.1           | 172  |
| SI .. ES         | Rod ends requiring maintenance, female thread, steel/steel                                | 6.1           | 172  |
| SI .. ES-2RS     | Rod ends requiring maintenance, female thread, steel/steel                                | 6.1           | 172  |
| SI .. TXE-2LS    | Maintenance-free rod ends, female thread, steel/PTFE fabric                               | 7.3           | 198  |
| SIA .. ES-2RS    | Rod ends requiring maintenance, female thread, steel/steel                                | 6.1           | 172  |
| SIA .. TXE-2LS   | Maintenance-free rod ends, female thread, steel/PTFE fabric                               | 7.3           | 198  |
| SIJ .. E         | Rod ends requiring maintenance for hydraulic cylinders, female thread, steel/steel        | 6.2           | 174  |
| SIJ .. ES        | Rod ends requiring maintenance for hydraulic cylinders, female thread, steel/steel        | 6.2           | 174  |
| SIKAC .. M       | Rod ends requiring maintenance, female thread, steel/bronze                               | 6.6           | 184  |
| SIKAC .. M/VZ019 | Rod ends requiring maintenance, female thread, steel/bronze, thread differs from standard | 6.6           | 184  |
| SIKB .. F        | Maintenance-free rod ends, female thread, steel/PTFE FRP                                  | 7.5           | 202  |
| SIKB .. F/VZ019  | Maintenance-free rod ends, female thread, steel/PTFE FRP, thread differs from standard    | 7.5           | 202  |
| SIL .. C         | Maintenance-free rod ends, female thread, steel/PTFE sintered bronze                      | 7.1           | 194  |
| SIL .. E         | Rod ends requiring maintenance, female thread, steel/steel                                | 6.1           | 172  |
| SIL .. ES        | Rod ends requiring maintenance, female thread, steel/steel                                | 6.1           | 172  |
| SIL .. ES-2RS    | Rod ends requiring maintenance, female thread, steel/steel                                | 6.1           | 172  |
| SIL .. TXE-2LS   | Maintenance-free rod ends, female thread, steel/PTFE fabric                               | 7.3           | 198  |
| SILA .. ES-2RS   | Rod ends requiring maintenance, female thread, steel/steel                                | 6.1           | 172  |
| SILA .. TXE-2LS  | Maintenance-free rod ends, female thread, steel/PTFE fabric                               | 7.3           | 198  |
| SILJ .. E        | Rod ends requiring maintenance for hydraulic cylinders, female thread, steel/steel        | 6.2           | 174  |
| SILJ .. ES       | Rod ends requiring maintenance for hydraulic cylinders, female thread, steel/steel        | 6.2           | 174  |
| SILKAC .. M      | Rod ends requiring maintenance, female thread, steel/bronze                               | 6.6           | 184  |
| SILKB .. F       | Maintenance-free rod ends, female thread, steel/PTFE FRP                                  | 7.5           | 202  |
| SILQG .. ES      | Rod ends requiring maintenance for hydraulic cylinders, female thread, steel/steel        | 6.2           | 174  |
| SILQG .. ESA     | Rod ends requiring maintenance for hydraulic cylinders, female thread, steel/steel        | 6.2           | 174  |
| SILR .. ES       | Rod ends requiring maintenance for hydraulic cylinders, female thread, steel/steel        | 6.2           | 174  |
| SIQG .. ES       | Rod ends requiring maintenance for hydraulic cylinders, female thread, steel/steel        | 6.2           | 174  |
| SIQG .. ESA      | Rod ends requiring maintenance for hydraulic cylinders, female thread, steel/steel        | 6.2           | 174  |
| SIR .. ES        | Rod ends requiring maintenance for hydraulic cylinders, female thread, steel/steel        | 6.2           | 174  |









